



**NATIONAL TECHNICAL UNIVERSITY OF
ATHENS**

**SCHOOL OF APPLIED MATHEMATICS AND
PHYSICAL SCIENCES**

DEPARTMENT OF MATHEMATICS

**THE HOMFLYPT SKEIN MODULE OF THE
LENS SPACES $L(p,1)$**

PhD THESIS

IOANNIS DIAMANTIS

B.Sc. In Mathematics, University of Athens

THESIS ADVISOR:

SOFIA LAMBROPOULOU

PROFESSOR N.T.U.A.

ATHENS, July 2015



**NATIONAL TECHNICAL UNIVERSITY OF
ATHENS**

**SCHOOL OF APPLIED MATHEMATICS AND
PHYSICAL SCIENCES**

DEPARTMENT OF MATHEMATICS

**THE HOMFLYPT SKEIN MODULE OF THE
LENS SPACES $L(p,1)$**

PhD THESIS

IOANNIS DIAMANTIS

B.Sc. In Mathematics, University of Athens

THREE MEMBER ADVISORY COMMITTEE:

1. S LAMBROPOULOU, Prof. N.T.U.A. (Advisor)
2. P. PAPAZOGLU, Prof. U.O.A.
3. J. H. PRZYTYCKI, Prof. G.W.U.

EXAMINATION COMMITTEE:

1. S LAMBROPOULOU, Prof. N.T.U.A. (Advisor)
2. P. PAPAZOGLU, Prof. U.O.A.
3. J. H. PRZYTYCKI, Prof. G.W.U.
4. C. GORDON, Prof. U.O.T.A.
5. T. RASSIAS, Prof. N.T.U.A.
6. E. KECHAGIAS, Prof. U.O.I.
7. D. KODOKOSTAS, Lecturer N.T.U.A.

ATHENS, July 2015



NATIONAL TECHNICAL UNIVERSITY OF ATHENS

SCHOOL OF APPLIED MATHEMATICS AND PHYSICAL SCIENCES

DEPARTMENT OF MATHEMATICS

The Homflypt skein module of the lens spaces $L(p, 1)$

IOANNIS DIAMANTIS

Examination Committee

Sofia Lambropoulou
Professor N.T.U.A. (Thesis Advisor)

Panagiotis Papazoglou
Professor U.O.A. (Thesis Committee)

Jozef H. Przytycki
Professor G.W.U. (Thesis Committee)

Cameron Gordon
Professor U.O. Austin at Texas

Themistocles M. Rassias
Professor N.T.U.A.

Epameinondas Kechagias
Professor U.O. Ioannina

Dimitrios Kodokostas
Lecturer N.T.U.A.

ΠΕΡΙΛΗΨΗ

Στη παρούσα διδακτορική διατριβή προτείνουμε μια νέα μέθοδο για τον υπολογισμό skein modules 3-πολλαπλοτήτων μέσω ομάδων πλεξίδων και πηλικά αυτών. Τα skein modules 3-πολλαπλοτήτων αποτελούν σημαντικά αλγεβρικά εργαλεία για την μελέτη των 3-πολλαπλοτήτων, καθώς οι ιδιότητές τους παρέχουν σημαντικές τοπολογικές πληροφορίες για τις ίδιες τις 3-πολλαπλότητες. Αναπτύσσουμε λοιπόν όλα τα απαραίτητα εργαλεία για τον υπολογισμό του Homflypt skein module των φακοειδών χώρων $L(p,q)$ και εστιάζουμε στη περίπτωση $q=1$. Τα αποτελέσματα της παρούσας διατριβής ορίζουν ένα ομογενές πλαίσιο για τη μελέτη κόμβων και κρίκων σε 3-πολλαπλότητες και σε οικογένειες 3-πολλαπλοτήτων.

ABSTRACT

The present PhD thesis develops an algebraic approach in the computation of skein modules of 3-manifolds. Its primary motivation is the computation of the Homflypt skein module of the lens spaces $L(p,q)$. Skein modules are quotients of free modules over ambient isotopy classes of knots and links in a 3-manifold by properly chosen skein relations. A skein module of a 3-manifold M based on the Homflypt skein relation is called Homflypt skein module of M . Skein modules of 3-manifolds have become very important algebraic tools in the study of 3-manifolds, since their properties renders topological information about the 3-manifolds. In this thesis we work towards the Homflypt skein module of the lens spaces $L(p,1)$ via braids. The advantage of the braid approach is that it gives more control over the band moves than the diagrammatic approach and much of the diagrammatic complexity is absorbed into the proofs of the algebraic statements.

This thesis is dedicated to
Marianna, to Nektarios
& to my parents
Athanasios & Freideriki

I. Diamantis
Athens, 23 December 2014

ACKNOWLEDGMENTS

Foremost, I would like to express my sincere gratitude to my advisor Prof. Sofia Lambropoulou for her continuous support, patience, motivation, enthusiasm, and immense knowledge. Her guidance helped me in all the time of research and writing of this thesis. I could not imagine having a better advisor and mentor for my Ph.D study.

Besides my advisor, I would like to thank the rest of my thesis committee and especially Prof. Dimitrios Kodokostas for his encouragement and insightful comments. My sincere thanks also goes to Prof. Maria Chlouveraki and Bostjan Gabrovsek for fruitful conversation and Prof. Panagiotis Psarakos and Prof. Argyrios Fellouris for their helpful career advice and suggestions in general.

I would also like to thank my family for the support, unconditional love and care they provided me through my entire life. I would not have made it this far without them.

I must acknowledge my soulmate and best friend Marianna and my brother and “benefactor” (!) Nektarios, without whose love, encouragement and support, I would not have finished this thesis.

Last but not least, I would like to place on record my sense of gratitude to all who directly or indirectly have helped me in this venture, and especially N. Kovatsos, E. Karli, D. Simos, E. Androulakis, E. Floraki, D. Stogiannis, E. Karantzas and K. Ksystra.

In conclusion, I express my gratitude and I recognize that this research would not have been possible without the financial assistance of the National Technical University of Athens and the grant “*Algebraic modeling of topological and computational structures*”, program THALIS of the Greek Ministry of Education (NSRF) & EU (ESF) (2012–2014).

The knowledge of which geometry aims
is the knowledge of the eternal.

Plato, Republic, VII.

The Homflypt skein module of the lens spaces $L(p, 1)$

Ioannis Diamantis

Department of Mathematics
School of Applied Mathematics and Physical Sciences
National Technical University of Athens
Athens, Greece
2014

ABSTRACT

The present thesis develops an algebraic approach in the computation of skein modules of 3-manifolds. Its primary motivation is the computation of the Homflypt skein module of the lens spaces $L(p, q)$. Skein modules are quotients of free modules over ambient isotopy classes of knots and links in a 3-manifold by properly chosen skein relations. A skein module of a 3-manifold M based on the Homflypt skein relation is called *Homflypt skein module* of M , also known as *Conway skein module* and as *third skein module*. Skein modules of 3-manifolds have become very important algebraic tools in the study of 3-manifolds, since their properties renders topological information about the 3-manifolds. In this thesis we work towards the Homflypt skein module of the lens spaces $L(p, 1)$ via braids. The advantage of the braid approach is that it gives more control over the band moves than the diagrammatic approach and much of the diagrammatic complexity is absorbed into the proofs of the algebraic statements.

In Chapter 1 we give introductory notions from Knot Theory and we present an overview of the subject of Homflypt skein modules of 3-manifolds, giving emphasis to the mathematical tools needed for this thesis. More precisely, we first present the Iwahori-Hecke algebra of type A and its properties, and then we construct the classical Homflypt polynomial for knots and links in S^3 . We pass to the generalized Iwahori-Hecke algebra of type B, which is related to the knot theory of the solid torus and which plays a crucial role for this thesis. We discuss its properties and present the Homflypt

polynomial for knots and links in the solid torus. Moreover, we describe geometric and algebraic mixed braid equivalence for knots and links in 3-manifolds obtained from S^3 by integral surgery along a framed link and we give the formal definition of the Homflypt skein module of a 3-manifold.

In Chapter 2 we describe braid equivalence for knots and links in a 3-manifold M obtained by rational surgery along a framed link in S^3 . We first prove a sharpened version of the Reidemeister theorem for links in M . We then give geometric formulations of the braid equivalence via mixed braids in S^3 using the L -moves and the braid band moves. We finally give algebraic formulations in terms of the mixed braid groups $B_{m,n}$ using cabling and the techniques of parting and combing for mixed braids. Our results set a homogeneous ground for the algebraic braid equivalences for link isotopy in families of 3-manifolds. We provide concrete formulæ of the braid equivalences in lens spaces, Seifert manifolds, homology spheres obtained from the trefoil and manifolds obtained from torus knots. The algebraic classification of links in a 3-manifold via mixed braids is a useful tool for computing the Witten invariants and for studying skein modules of 3-manifolds and of families of 3-manifolds.

In Chapter 3 we give a new basis, Λ , for the Homflypt skein module of the solid torus, $S(\text{ST})$, other than the one of Hoste–Kidwell [HK90] and Turaev [Tur88], conjectured by J. H. Przytycki. For doing this we use the generalized Hecke algebra of type B, $H_{1,n}$, defined by Lambropoulou [Lam99], which is isomorphic to the affine Hecke algebra of type A. In order to show that the set Λ is a basic set for $S(\text{ST})$ we start with the well-known basis of $S(\text{ST})$, Λ' , discovered independently in [Tur88] and [HK90] with diagrammatic methods, and a basis Σ_n of the algebra $H_{1,n}$. We define an ordering relation in Λ' and prove that the set is totally ordered. We then convert elements in Λ' to linear combinations of elements in the new basic set Λ . This is done in two steps: First we convert elements in Λ' to elements in Σ_n . Then, using conjugation and

stabilization moves, we convert these elements to linear combinations of elements in Λ . Finally, we relate the sets Λ' and Λ via a block diagonal matrix, where each block is an infinite lower triangular matrix with invertible elements in the diagonal. The infinite matrix is then invertible and thus, the set Λ is a basis for $S(\text{ST})$. The new basis is appropriate for computing the Homflypt skein module of the lens spaces.

$S(\text{ST})$ plays an important role in the study of Homflypt skein modules of arbitrary c.c.o. 3-manifolds, since every c.c.o. 3-manifold can be obtained by surgery along a framed link in S^3 with unknotted components. The family of the lens spaces, $L(p, q)$, comprises the simplest example, since they are obtained by rational surgery on the unknot. The aim of this chapter is to set a homogeneous ground in computing skein modules of c.c.o. 3-manifolds via algebraic means.

In Chapter 4 we give a basis for the Homflypt skein module of the lens spaces $L(p, 1)$ using the braid approach and results from [Lam99, LR06, DL15]. We first show the connection between $S(\text{ST})$ and $S(L(p, 1))$. In particular, we show that $S(L(p, 1))$ is obtained from $S(\text{ST})$ by considering relations coming from the braid band move on elements in the basis Λ , where the braid band move is only performed on the first moving strand of each element. We then study an infinite system of equations coming from the braid band moves and we show that the system splits into self-contained subsystems. We investigate other useful properties of the system such as “symmetry” in equations. We then define an ordering relation on the unknowns that respects the ordering defined in Chapter 3 for elements in Λ , and show some combinatorial results derived by the ordering. In [GM14], $S(L(p, 1))$ is computed diagrammatically and the result suggests that the infinite system admits unique solution, leading to the following basis for $S(L(p, 1))$:

$$B_p = \{t^{d_0}t_1^{d_1} \dots t_m^{d_m} : m \in \mathbb{N}, d_i \in \mathbb{N}^* \forall i : d_0 < d_1 < \dots < d_m \leq p - 1\}.$$

The importance of our approach is that it can shed light to the problem of computing skein modules of arbitrary c.c.o. 3-manifolds, since any 3-manifold can be obtained by

surgery on S^3 along unknotted closed curves. Indeed, one can use our results in order to apply a braid approach to the skein module of an arbitrary c.c.o. 3-manifold. The main difficulty of the problem lies in selecting from the infinitum of band moves (or handle slide moves) some basic ones, solving the infinite system of equations and proving that there are no dependencies in the solutions.

Περίληψη

Στη παρούσα διδακτορική διατριβή προτείνουμε μια νέα μέθοδο για τον υπολογισμό skein modules 3-πολλαπλοτήτων μέσω ομάδων πλεξίδων και πηλίκα αυτών. Τα skein modules 3-πολλαπλοτήτων αποτελούν σημαντικά αλγεβρικά εργαλεία στη μελέτη των 3-πολλαπλοτήτων, καθώς οι ιδιότητές τους παρέχουν σημαντικές τοπολογικές πληροφορίες για τις ίδιες τις 3-πολλαπλότητες. Θα αναπτύξουμε όλα τα απαραίτητα αλγεβρικά εργαλεία για τον υπολογισμό του Homflypt skein module των φακοειδών χώρων $L(p, 1)$.

Στο Κεφάλαιο 1 παρουσιάζουμε μια εισαγωγή στη Θεωρία Κόμβων δίνοντας έμφαση στον αλγεβρικό τρόπο ανάκτησης του Homflypt skein module του στερεού τόρου μέσω των γενικευμένων αλγεβρών Iwahori-Hecke τύπου B. Αρχικά παρουσιάζουμε τις άλγεβρες Iwahori-Hecke τύπου A και κατασκευάζουμε το πολυώνυμο Homflypt για κόμβους και κρίκους στην S^3 . Στη συνέχεια παρουσιάζουμε τις γενικευμένες άλγεβρες Iwahori-Hecke τύπου B, οι οποίες συνδέονται με τη θεωρία κόμβων του στερεού τόρου και οι οποίες παίζουν πρωταρχικό ρόλο στη παρούσα διατριβή, αναλύουμε ιδιότητές τους και κατασκευάζουμε το πολυώνυμο Homflypt για κόμβους και κρίκους στον στερεό τόρο. Τέλος, παρουσιάζουμε τη γεωμετρική και αλγεβρική ισοδυναμία πλεξίδων για κόμβους και κρίκους σε 3-πολλαπλότητες οι οποίες προκύπτουν από την σφαίρα S^3 μέσω ακέραιας χειρουργικής κατά μήκος ενός πλαισιωμένου κόμβου.

Στο Κεφάλαιο 2 παρουσιάζουμε τη γεωμετρική και αλγεβρική ισοδυναμία μικτών πλεξίδων για κόμβους και κρίκους σε 3-πολλαπλότητες οι οποίες προκύπτουν από την S^3 με τη μέθοδο της χειρουργικής κατά μήκος ενός πλαισιωμένου κόμβου με ρητό συντελεστή. Η χειρουργική σε έναν πλαισιωμένο κόμβο με ρητό συντελεστή αποτελεί γενίκευση της ακέραιας χειρουργικής. Μερικά σημαντικά πλεονεκτήματά της είναι ότι μπορεί να περιγράψει ολόκληρες οικογένειες 3-πολλαπλοτήτων οι οποίες παράγονται από τον ίδιο πλαισιωμένο κρίκο (με διαφορετικό συντελεστή), όπως για παράδειγμα οι φακοειδείς χώροι $L(p, q)$, και

ότι πολλές 3-πολλαπλότητες έχουν απλούστερη περιγραφή μέσω αυτής, όπως για παράδειγμα οι πολλαπλότητες Seifert. Αρχικά αναπαριστούμε την 3-πολλαπλότητα M με μία κλειστή, πλαισιωμένη πλεξίδα στην S^3 και αναπαριστούμε κρίκους στην M με κλειστές, μικτές πλεξίδες στην S^3 . Στη συνέχεια γενικεύουμε το Θεώρημα Reidemeister για κρίκους στην M , και αποδεικνύουμε μια βελτιωμένη έκδοση αυτού, στην οποία απαιτείται μόνο μία από τις δύο νέες κινήσεις ισοτοπίας, band moves. Πιο συγκεκριμένα, αποδεικνύουμε ότι δύο προσανατολισμένοι κρίκοι L_1, L_2 στην M είναι ισοτοπικοί αν και μόνο αν αντίστοιχα μικτά διαγράμματά τους διαφέρουν κατά πεπερασμένο πλήθος κινήσεων band moves τύπου α και από κινήσεις ισοτοπίας στην $S^3 \setminus \widehat{B}$. Στη συνέχεια δίνουμε την γεωμετρική ισοδυναμία μικτών πλεξίδων χρησιμοποιώντας της κινήσεις L και τις braid band moves. Διατυπώνουμε και αποδεικνύουμε τέλος την αλγεβρική ισοδυναμία πλεξίδων μέσω των ομάδων μικτών πλεξίδων $B_{m,n}$, χρησιμοποιώντας την τεχνική της καλωδίωσης, την τεχνική standard parting και την τεχνική combing. Η έννοια της καλωδίωσης μας επιτρέπει να περιγράψουμε πιο απλά τις κινήσεις braid band moves, καθώς μας επιτρέπει να θεωρούμε κάθε καλώδιο ως μία παχιά κλωστή. Η εφαρμογή της τεχνικής standard parting σε μια γεωμετρική μικτή πλεξίδα οδηγεί σε μια parted μικτή πλεξίδα, δηλαδή σε μια μικτή πλεξίδα στην οποία έχουμε διαχωρίσει τις $m + n$ στο πλήθος κλωστές σε δύο μέρη: στις πρώτες m κλωστές, οι οποίες αντιπροσωπεύουν το σταθερό μέρος της μικτής πλεξίδας, και στις υπόλοιπες n , οι οποίες αποτελούν το κινούμενο μέρος αυτής. Με την εφαρμογή της τεχνικής combing σε μια parted μικτή πλεξίδα διαχωρίζουμε την πλεξίδα σε δύο μέρη: στο αλγεβρικό μέρος αρχικά, στο οποίο οι σταθερές κλωστές σχηματίζουν την ταυτοτική πλεξίδα (και επομένως αποτελούν στοιχείο κάποιας μικτής ομάδας πλεξίδων $B_{m,n}$) και το οποίο περιέχει όλες τις διασταυρώσεις του κρίκου K στην M , και στο coset μέρος $C_{m,n}$ στη συνέχεια, το οποίο περιλαμβάνει όλες τις διασταυρώσεις μεταξύ των σταθερών κλωστών της υποπλεξίδας B (και το κινούμενο μέρος σχηματίζει την ταυτοτική πλεξίδα). Αποδεικνύουμε τέλος ότι δύο προσανατολισμένοι κρίκοι στην M είναι ισοτοπικοί αν και μόνο αν αντίστοιχες αλγεβρικές μικτές πλεξίδες αυτών διαφέρουν κατά πεπερασμένο πλήθος των κινήσεων Algebraic M -

conjugation, Algebraic M-move (ή ισοδύναμα με τις αλγεβρικές κινήσεις L), *Combed loop conjugation, Combed algebraic braid band moves*.

Τα αποτελέσματα του Κεφαλαίου 2 ορίζουν ένα ομογενές αλγεβρικό περιβάλλον για τη μελέτη κρίκων σε 3-πολλαπλότητες και σε οικογένειες 3-πολλαπλοτήτων χρησιμοποιώντας υπολογιστικά εργαλεία. Στην § 2.7 παρουσιάζουμε αναλυτικά την ισοδυναμία πλεξίδων σε οικογένειες 3-πολλαπλοτήτων, όπως οι φακοειδείς χώροι, οι πολλαπλότητες Seifert, οι σφαίρες ομολογίας οι οποίες παράγονται από τον κόμβο τριφύλλι και οι πολλαπλότητες που περιγράφονται από torus κόμβους. Προτείνουμε τέλος κάποιες εφαρμογές στον υπολογισμό αναλλοίωτων κόμβων τύπου Jones σε 3-πολλαπλότητες, στην μετάφραση του Rational Calculus του Rolfsen με όρους πλεξίδων και στον υπολογισμό αναλλοίωτων Witten.

Στο Κεφάλαιο 3 παρουσιάζουμε μία νέα βάση για το Homflypt skein module του στερεού τόρου. Ο Turaev και ανεξάρτητα οι Kidwell-Hoste έδωσαν μια βάση, Λ' , του Homflypt skein module του στερεού τόρου $S(ST)$ με διαγραμματικές μεθόδους. Η βάση Λ' του $S(ST)$ είναι κατάλληλη για να οριστεί η αναλλοίωτη X της Λαμπροπούλου, αλλά είναι πολύ δύσκολο να περιγράψει το αποτέλεσμα μιας κίνησης braid band move, κάτι που επιτυγχάνει με φυσικό τρόπο η νέα βάση που προτείνουμε, Λ . Ορίζουμε αρχικά μια διάταξη στα σύνολα Λ και Λ' και αποδεικνύουμε ότι τα σύνολα αυτά, εφοδιασμένα με τη διάταξη που ορίσαμε, αποτελούν ολικά διατεταγμένα σύνολα. Ξεκινάμε από στοιχεία της βάσης Λ' και τα εκφράζουμε ως γραμμικό συνδυασμό στοιχείων του συνόλου Σ_n , το οποίο αποτελεί βάση της γενικευμένης άλγεβρας Iwahori-Hecke τύπου B, $H_{1,n}(q)$. Τα στοιχεία που προκύπτουν ενδέχεται να έχουν κενά στους δείκτες των γεννητόρων t_i (gaps), οι εκθέτες των γεννητόρων αυτών ενδέχεται να μην βρίσκονται σε φθίνουσα σειρά, και τέλος, ενδέχεται να ακολουθούνται από στοιχεία της άλγεβρας Iwahori-Hecke τύπου A, $H_n(q)$ (tails). Χρησιμοποιώντας stabilization moves και conjugation, αποδεικνύουμε ότι κάθε στοιχείο του Σ_n μπορεί να εκφραστεί ως γραμμικός συνδυασμός στοιχείων του συνόλου Λ (Θεωρήματα Managing the gaps, Ordering the exponents, Eliminating the tails). Τέλος, για να δείξουμε ότι το σύνολο Λ αποτελεί βάση του Homflypt skein module του στερεού τόρου,

συνδέουμε τα δύο σύνολα Λ και Λ' με έναν άπειρο, κάτω τριγωνικό πίνακα με αντιστρέψιμα στοιχεία στη κύρια διαγώνιο χρησιμοποιώντας την διάταξη που ορίσαμε στα σύνολα αυτά, και δείχνουμε ότι το σύνολο Λ είναι γραμμικά ανεξάρτητο. Το σύνολο Λ λοιπόν αποτελεί βάση του Homflypt skein module του στερεού τόρου.

Στο Κεφάλαιο 4 παρουσιάζουμε μία νέα βάση για το Homflypt skein module των φακοειδών χώρων $L(p, 1)$, $S(L(p, 1))$. Στην §2.7.2 παρουσιάστηκε η ισοδυναμία πλεξίδων για κόμβους στον $L(p, 1)$ και στο 3.2 παρουσιάζεται η νέα βάση του $S(ST)$, η οποία είναι κατάλληλη να περιγράψει τις νέες κινήσεις ισοτοπίας braid band moves. Αρχικά αποδεικνύουμε ότι ο υπολογισμός του $S(L(p, 1))$ προκύπτει από το $S(ST)$ αν αναλύσουμε σχέσεις που προκύπτουν μετά την εφαρμογή μιας $(p, 1)$ -braid band move, συμβολικά: $S(L(p, 1)) = \frac{S(ST)}{\langle bbm \rangle}$. Η μέθοδος που ακολουθούμε είναι να επιβάλλουμε στην αναλλοίωτη X (1.10) της Λαμπροπούλου για κόμβους και κρίκους στον στερεό τόρο, ίδια τιμή για δύο μικτούς κρίκους που διαφέρουν κατά μία κίνηση band move, ή ισοδύναμα, σε δύο μικτές πλεξίδες που διαφέρουν κατά μία κίνηση braid band move. Κατασκευάζουμε με αυτόν τον τρόπο ένα άπειρο σύστημα, οι λύσεις του οποίου οδηγούν στη βάση του $S(L(p, 1))$:

$$\left\{ \begin{array}{l} X_{\tau_{0,m}}^{\widehat{k_{0,m}}} = X_{t^p \tau_{1,m+1} g_1}^{\widehat{k_{0,m}}} \\ X_{\tau_{0,m}}^{\widehat{k_{0,m}}} = X_{t^p \tau_{1,m+1} g_1^{-1}}^{\widehat{k_{0,m}}} \end{array} \right.$$

Οι άγνωστοι του συστήματος προκύπτουν από τη συνάρτησης ίχνους της Λαμπροπούλου και αντιμετατίθενται. Χρησιμοποιώντας τη διάταξη στο σύνολο Λ , αποδεικνύουμε ότι το άπειρο σύστημα αποτελείται από ‘κλειστά’ και άπειρα στο πλήθος, πεπερασμένα υποσυστήματα, ‘κλειστά’ με την έννοια ότι οι άγνωστοι ενός υποσυστήματος δεν μπορούν να εμφανιστούν σε κανένα άλλο υποσύστημα. Ερευνούμε ακόμα ενδιαφέρουσες ιδιότητες του συστήματος όπως η ‘συμμετρία’ που εμφανίζεται σε συγκεκριμένες εξισώσεις. Στη συνέχεια ορίζουμε διάταξη στους αγνώστους του συστήματος η οποία σέβεται την διάταξη

της § 4.3 στοιχείων του Λ , και μέσω αυτής αποδεικνύουμε συνδυαστικά αποτελέσματα που αφορούν στο σύστημα με σκοπό να αποδείξουμε ότι το άπειρο αυτό σύστημα δέχεται μοναδική λύση, η οποία οδηγεί στη παρακάτω βάση του $S(L(p, 1))$:

$$B_p = \{t^{d_0}t_1^{d_1} \dots t_m^{d_m} : m \in \mathbb{N}, d_i \in \mathbb{N}^* \forall i : d_0 < d_1 < \dots < d_m \leq p - 1\}.$$

Τα παραπάνω αποτελέσματα παρουσιάστηκαν ή θα παρουσιαστούν στα ακόλουθα συνέδρια με τη μορφή ομιλιών ή poster:

1. Advanced School and Conference on Knot Theory and its Applications to Physics and Biology, 11 - 29 May 2009, ICTP, Trieste, Italy.
2. Knots in Chicago, 10-12 September 2010, Chicago, USA.
3. Knots and Links: From Form to Function, Pisa, Italy, July 02-07, 2011.
4. Swiss Knots, Switzerland, May 22-27, 2011.
5. Winterbraids II, 12-15 December 2011, Caen, France.
6. Winterbraids IV, 10-13 February 2014, Dijon, France.
7. Συνέδριο Άλγεβρας, 2-3 Μαΐου 2014, Θεσσαλονίκη.
8. Workshop THALES, Algebraic modeling of topological and computational structures, N.T.U.A., Athens, Greece, 1-3 July 2015.

Επίσης, τα αποτελέσματα της παρούσας διατριβής θα δημοσιευτούν σε έγκριτα, διεθνή, επιστημονικά περιοδικά:

- (1.) I. DIAMANTIS, S. LAMBROPOULOU, Braid equivalence in 3-manifolds with rational surgery description, arXiv:1311.2465 [math.GT], (2013) (submitted for publication to *Topology and its Applications*).
- (2.) I. DIAMANTIS, S. LAMBROPOULOU, A new basis for the Homflypt skein module of the solid torus, arxiv:1412.3642 [math.GT], (2014), (*Journal of Pure and Applied Algebra*, DOI 10.1016/j.jpaa.2015.06.014).
- (3.) I. DIAMANTIS, S. LAMBROPOULOU, J. PRZYTYCKI, A basis for the Homflypt skein module of $L(p, 1)$, (in preparation).

1.	<i>Preliminaries</i>	1
1.1	Knots and Links in S^3	1
1.2	Braids	2
1.3	The Homflypt polynomial of links in S^3	4
1.3.1	The Iwahori-Hecke algebra of type A, $H_n(q)$	4
1.4	Knot theory of the solid torus	5
1.4.1	Mixed Braids in S^3	5
1.5	The Homflypt polynomial of links in the solid torus	7
1.5.1	The Generalized Iwahori-Hecke Algebra of type B	7
1.6	Knots in manifolds obtained by integral surgery	9
1.6.1	The Reidemeister Theorem for links in 3-manifolds with integral surgery description	9
1.6.2	Geometric mixed braids and the L -moves	10
1.6.3	Algebraic mixed braids and their equivalence	11
1.7	Homflypt Skein Modules	15
2.	<i>Braid equivalence in 3-manifolds with rational surgery description</i>	19
2.1	Introduction	19
2.2	The Reidemeister Theorem for links in 3-manifolds	23
2.3	Geometric \mathbb{Q} -mixed braid equivalence	26
2.3.1	Introducing cabling	28
2.4	Parted \mathbb{Q} -mixed braid equivalence	28
2.5	Combing and cabling	30
2.6	Algebraic \mathbb{Q} -mixed braid equivalence	33
2.7	Applications	38
2.7.1	Illustrations for an abstract generic example	38
2.7.2	Lens spaces $L(p, q)$	44
2.7.3	Homology spheres	45
2.7.4	Seifert Manifolds	46

2.7.5	Rational surgery along a torus knot	47
2.7.6	Jones-type invariants and skein modules of 3-manifolds	48
2.7.7	Application to the equivalence of 3-manifolds	50
3.	<i>A new basis for the Homflypt skein module of the solid torus</i>	51
3.1	Introduction	51
3.2	An ordering in the sets Λ and Λ'	54
3.3	From Λ' to Σ_n	57
3.3.1	Some useful lemmas in $H_{1,n}(q)$	57
3.3.2	Converting elements in Λ' to elements in Σ_n	63
3.4	From Σ_n to Λ	65
3.4.1	Managing the gaps	66
3.4.2	Ordering the exponents	71
3.4.3	Eliminating the tails	73
3.5	The basis Λ of $\mathcal{S}(\text{ST})$	75
3.5.1	The infinite matrix	75
3.5.2	Linear independence of Λ	77
3.5.3	The proof of the main result	78
3.6	Appendix	78
3.6.1	From Σ_n to Σ'_n	78
3.6.2	Useful lemmas	79
4.	<i>The Homflypt skein module of the lens spaces $L(p, 1)$ via braids</i>	85
4.1	Introduction	86
4.2	Topological steps towards $\mathcal{S}(L(p, 1))$	86
4.2.1	From diagrams in ST to elements in Σ'_n	88
4.2.2	From the set Σ'_n to the set Σ_n	89
4.2.3	From Σ_n to the $H_n(q)$ -module $\Lambda_{(n)}$: managing the gaps and ordering the exponents	90
4.2.4	From the $H_n(q)$ -module $\Lambda_{(n)}$ to Λ_n : eliminating the tails	93
4.2.5	From Λ to L : restrictions on the braid band moves	95
4.3	The infinite system	96
4.3.1	Some combinatorial results on the system	99
4.4	Appendix	101
	<i>Bibliography</i>	105

1.1 Knots and Links in S^3

Definition 1.1. A *link of m -components* is a subset of S^3 , or \mathbb{R}^3 , that consists of m disjoint, piecewise linear, simple, closed curves. A link of one component is a *knot* (see Fig. 1.1).

Definition 1.2. Two links L_1, L_2 in S^3 are equivalent (or isotopic), denoted by $L_1 \sim L_2$, if there is an orientation-preserving piecewise linear homeomorphism $h : S^3 \rightarrow S^3$, such that $h(L_1) = L_2$.

Definition 1.3. A link diagram is a diagram of a link on the plane, where each line segment of the link is projected to a line segment in \mathbb{R}^2 , such that two segments intersect at most one point, which for disjoint segments is not an end point, and that no point belongs to the projections of three segments.

Theorem 1.1 (Reidemeister). *Two link diagrams correspond to isotopic links if and only if one can be obtained from the other by a finite sequence of Reidemeister moves (Fig. 1.2) and plane isotopies (Delta moves) (Fig. 1.3).*



Fig. 1.1: A knot and a 2-component link.

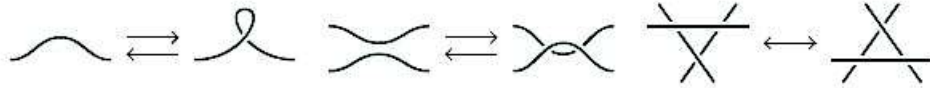

Fig. 1.2: The Reidemeister moves.

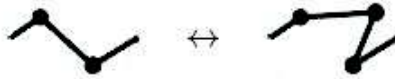

Fig. 1.3: Delta move.

1.2 Braids

Definition 1.4. A *braid* in n strands is defined as a set of pairwise nonintersecting descending polygonal lines (strands) joining the points A_1, A_2, \dots, A_n to the points B_1, B_2, \dots, B_n in any order, where $A_i = (i, 0, 0)$ and $B_i = (i, 0, 1)$ for $i = 1, 2, \dots, n$.

Definition 1.5. Two braids are called *isotopic* if and only if one can be transformed into the other by a finite sequence of elementary deformations.

The set of (equivalent classes of) braids in n strands has a natural group structure:

The product of two braids a and b is obtained by putting them end to end as shown in Figure 1.5.

The unit element is the braid consisting of n parallel vertical strands and the inverse of a braid a , a^{-1} , is the mirror image of a in the plane. The set of braids in n strands under this operation is called the braid group and is denoted by B_n .

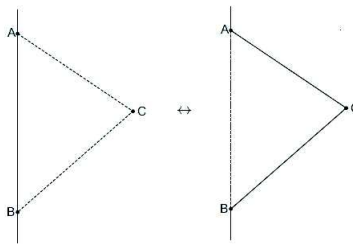

Fig. 1.4: Elementary deformations.

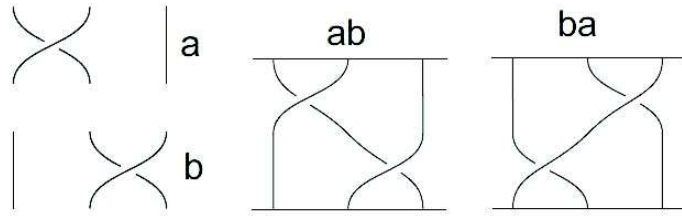

Fig. 1.5: The product of two braids a and b .



Fig. 1.6: The generator σ_i and its inverse σ_i^{-1} for B_n .

Theorem 1.2 (Artin). *The equivalence relation upon braid words defined by the relations*

$$\sigma_i \sigma_j = \sigma_j \sigma_i \quad \text{for } |i - j| > 1$$

$$\sigma_i \sigma_{i+1} \sigma_i = \sigma_{i+1} \sigma_i \sigma_{i+1}$$

is identical to the equivalence relations of braid isotopy upon braids represented by the braid words.

Because of Theorem 1.2, B_n has the presentation:

$$B_n = \left\langle \sigma_1, \dots, \sigma_{n-1} \mid \begin{array}{l} \sigma_i \sigma_{i+1} \sigma_i = \sigma_{i+1} \sigma_i \sigma_{i+1}, \quad 1 \leq i \leq n-2 \\ \sigma_i \sigma_j = \sigma_j \sigma_i, \quad |i - j| > 1 \end{array} \right\rangle.$$

Definition 1.6. The *closure* of a braid a is defined as the link \hat{a} obtained by joining the upper points of its strands to the lower ones (see Fig. 1.7).

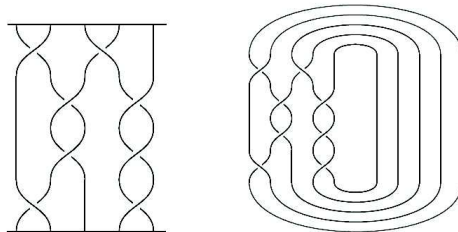

Fig. 1.7: The closure of a braid.

Theorem 1.3 (Alexander). *Any link is the closure of some braid.*

Theorem 1.4 (Markov). *The closures of two braids are isotopic if and only if one braid can be taken to another by finite sequence of the following moves:*

$$\text{Conjugation : } a \leftrightarrow bab^{-1}, \quad a, b \in B_n,$$

$$\text{Stabilization : } a \leftrightarrow a\sigma_n^{-1}, \quad a \in B_n.$$

1.3 The Homflypt polynomial of links in S^3

1.3.1 The Iwahori-Hecke algebra of type A, $H_n(q)$

A presentation of $H_n(q)$ is obtained from the presentation of the braid group B_n by adding the quadratic relation $g_i^2 = (q-1)g_i + q$, $q \in \mathbb{C}$ a fixed variable. The algebra $H_n(q)$ has the following presentation:

$$H_n(q) = \left\langle g_1, g_2, \dots, g_{n-1} \left| \begin{array}{l} g_i g_{i+1} g_i = g_{i+1} g_i g_{i+1}, \quad 1 \leq i \leq n-2 \\ g_i g_j = g_j g_i, \quad |i-j| > 1 \\ g_i^2 = (q-1)g_i + q, \quad i = 1, 2, \dots, n-1 \end{array} \right. \right\rangle,$$

that is

$$H_n(q) = \frac{\mathbb{Z}[q^{\pm 1}] B_n}{\langle \sigma_i^2 - (q-1)\sigma_i - q \rangle}.$$

In [Jon87] V.F.R. Jones gives the following linear basis for the Iwahori-Hecke algebra of type A, $H_n(q)$:

$$S = \left\{ (g_{i_1} g_{i_1-1} \dots g_{i_1-k_1}) (g_{i_2} g_{i_2-1} \dots g_{i_2-k_2}) \dots (g_{i_p} g_{i_p-1} \dots g_{i_p-k_p}) \right\}, \text{ for } 1 \leq i_1 < \dots < i_p \leq n-1.$$

The basis S yields directly an inductive basis for $H_n(q)$, which is used in the construction of the Ocneanu trace, leading to the Homflypt or 2-variable Jones polynomial ($\dim H_n(q) = n!$).

Theorem 1.5 (Ocneanu). *There exists a unique linear Markov trace function:*

$$\text{tr} : \bigcup_{n=1}^{\infty} H_n(q) \rightarrow \mathbb{C},$$

determined by the rules:

$$\begin{array}{lll} (1) & \text{tr}(ab) & = \text{tr}(ba) \quad \text{for } a, b \in H_n(q) \\ (2) & \text{tr}(1) & = 1 \quad \text{for all } H_{1,n}(q) \\ (3) & \text{tr}(ag_n) & = z \text{tr}(a) \quad \text{for } a \in H_n(q) \end{array}$$



Fig. 1.8: A mixed link in S^3 .

Theorem 1.6. *The function $X : \mathcal{L} \rightarrow \mathbb{Z}[q^{\pm 1}, z, \lambda]$*

$$X_L(q, \lambda) = \left[-\frac{1 - \lambda q}{\sqrt{\lambda}(1 - q)} \right]^{n-1} (\sqrt{\lambda})^e \operatorname{tr}(\pi(\alpha)),$$

where $\alpha \in B_n$ is a word in the σ_i 's, e is the exponent sum of the σ_i 's in α , and π the canonical map of B_n in $H_n(q)$, such that $\sigma_i \mapsto g_i$, is an invariant of oriented links in ST.

1.4 Knot theory of the solid torus

We now view ST as the complement of a solid torus in S^3 . An oriented link L in ST can be represented by an oriented *mixed link* in S^3 , that is a link in S^3 consisting of the unknotted fixed part \widehat{I} representing the complementary solid torus in S^3 and the moving part L that links with \widehat{I} .

A *mixed link diagram* is a diagram $\widehat{I} \cup \widetilde{L}$ of $\widehat{I} \cup L$ on the plane of \widehat{I} , where this plane is equipped with the top-to-bottom direction of \widehat{I} .

Consider now an isotopy of an oriented link L in ST. As the link moves in ST, its corresponding mixed link will change in S^3 by a sequence of moves that keep the oriented \widehat{I} pointwise fixed. This sequence of moves consists in isotopy in the S^3 and the *mixed Reidemeister moves*. In terms of diagrams we have the following result for isotopy in ST:

The mixed link equivalence in S^3 includes the classical Reidemeister moves and the mixed Reidemeister moves, which involve the fixed and the standard part of the mixed link, keeping \widehat{I} pointwise fixed.

1.4.1 Mixed Braids in S^3

By the Alexander theorem for knots in solid torus, a mixed link diagram $\widehat{I} \cup \widetilde{L}$ of $\widehat{I} \cup L$ may be turned into a *mixed braid* $I \cup \beta$ with isotopic closure. This is a braid in S^3 where, without loss of generality, its first strand represents \widehat{I} , the fixed part, and the other strands, β , represent the moving part L . The subbraid β shall be called the *moving part* of $I \cup \beta$.

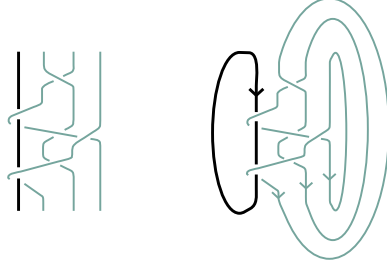

Fig. 1.9: The closure of a mixed braid to a mixed link.

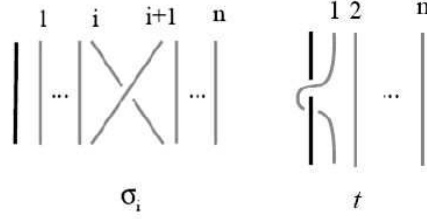

Fig. 1.10: The generators of $B_{1,n}$.

The sets of braids related to the ST form groups, which are in fact the Artin braid groups type B, denoted $B_{1,n}$, with presentation:

$$B_{1,n} = \left\langle t, \sigma_1, \dots, \sigma_{n-1} \left| \begin{array}{l} \sigma_1 t \sigma_1 t = t \sigma_1 t \sigma_1 \\ t \sigma_i = \sigma_i t, \quad i > 1 \\ \sigma_i \sigma_{i+1} \sigma_i = \sigma_{i+1} \sigma_i \sigma_{i+1}, \quad 1 \leq i \leq n-2 \\ \sigma_i \sigma_j = \sigma_j \sigma_i, \quad |i-j| > 1 \end{array} \right. \right\rangle,$$

where the generators σ_i and t are illustrated in Figure 1.10.

Isotopy in ST is translated on the level of mixed braids by means of the following theorem.

Theorem 1.7 (Theorem 3, [Lam94]). *Let L_1, L_2 be two oriented links in ST and let $I \cup \beta_1, I \cup \beta_2$ be two corresponding mixed braids in S^3 . Then L_1 is isotopic to L_2 in ST if and only if $I \cup \beta_1$ is equivalent to $I \cup \beta_2$ in $\bigcup_{n=1}^{\infty} B_{1,n}$ by the following moves:*

- (i) *Conjugation :* $\alpha \sim \beta^{-1} \alpha \beta$, if $\alpha, \beta \in B_{1,n}$.
- (ii) *Stabilization moves :* $\alpha \sim \alpha \sigma_n^{\pm 1} \in B_{1,n+1}$, if $\alpha \in B_{1,n}$.

1.5 The Homflypt polynomial of links in the solid torus

1.5.1 The Generalized Iwahori-Hecke Algebra of type B

It is well known that $B_{1,n}$ is the Artin group of the Coxeter group of type B, which is related to the Hecke algebra of type B, $H_n(q, Q)$ and to the cyclotomic Hecke algebras of type B. In [Lam99] it has been established that all these algebras form a tower of B-type algebras and are related to the knot theory of ST. The basic one is $H_n(q, Q)$, a presentation of which is obtained from the presentation of the Artin group $B_{1,n}$ by adding the quadratic relations

$$g_i^2 = (q - 1)g_i + q \quad (1.1)$$

and the relation $t^2 = (Q - 1)t + Q$, where $q, Q \in \mathbb{C} \setminus \{0\}$ are seen as fixed variables. The middle B-type algebras are the cyclotomic Hecke algebras of type B, $H_n(q, d)$, whose presentations are obtained by the quadratic relation (1.1) and $t^d = (t - u_1)(t - u_2) \dots (t - u_d)$. The topmost Hecke-like algebra in the tower is the *generalized Iwahori-Hecke algebra of type B*, $H_{1,n}(q)$, which, as observed by Tom Dieck, is related to the affine Hecke algebra of type A, $\tilde{H}_n(q)$ (cf. [Lam99]). The algebra $H_{1,n}(q)$ has the following presentation:

$$H_{1,n}(q) = \left\langle t, g_1, \dots, g_{n-1} \left| \begin{array}{l} g_1 t g_1 t = t g_1 t g_1 \\ t g_i = g_i t, \quad i > 1 \\ g_i g_{i+1} g_i = g_{i+1} g_i g_{i+1}, \quad 1 \leq i \leq n - 2 \\ g_i g_j = g_j g_i, \quad |i - j| > 1 \\ g_i^2 = (q - 1)g_i + q, \quad i = 1, \dots, n - 1 \end{array} \right. \right\rangle.$$

That is:

$$H_{1,n}(q) = \frac{\mathbb{Z}[q^{\pm 1}] B_{1,n}}{\langle \sigma_i^2 - (q - 1)\sigma_i - q \rangle}.$$

Note that in $H_{1,n}(q)$ the generator t satisfies no polynomial relation, making the algebra $H_{1,n}(q)$ infinite dimensional. Also that in [Lam99] the algebra $H_{1,n}(q)$ is denoted as $H_n(q, \infty)$.

In $H_{1,n}(q)$ we define the elements:

$$t_i := g_i g_{i-1} \dots g_1 t g_1 \dots g_{i-1} g_i \text{ and } t'_i := g_i g_{i-1} \dots g_1 t g_1^{-1} \dots g_{i-1}^{-1} g_i^{-1}, \quad (1.2)$$

as illustrated in Figure 1.11.

In [Lam99] the following result has been proved.

Theorem 1.8 (Proposition 1, Theorem 1 [Lam99]). *The following sets form linear bases*

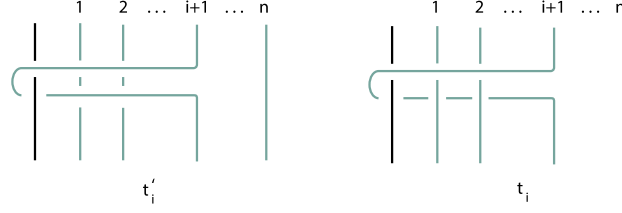

Fig. 1.11: The elements t'_i and t_i .

for $H_{1,n}(q)$:

$$(i) \quad \Sigma_n = \{t_{i_1}^{k_1} t_{i_2}^{k_2} \dots t_{i_r}^{k_r} \cdot \sigma, \text{ where } 1 \leq i_1 < \dots < i_r \leq n-1\},$$

$$(ii) \quad \Sigma'_n = \{t'_{i_1}{}^{k_1} t'_{i_2}{}^{k_2} \dots t'_{i_r}{}^{k_r} \cdot \sigma, \text{ where } 1 \leq i_1 < \dots < i_r \leq n\},$$

where $k_1, \dots, k_r \in \mathbb{Z}$ and σ a basic element in $H_n(q)$.

Remark 1.1. (i) The indices of the t'_i 's in the set Σ'_n are ordered but are not necessarily consecutive, neither do they need to start from t .

(ii) A more straight forward proof that the sets Σ'_n form bases for $H_{1,n}(q)$ can be found in the appendix.

In [Lam99] the basis Σ'_n is used for constructing a Markov trace on $\bigcup_{n=1}^{\infty} H_{1,n}(q)$.

Theorem 1.9 (Theorem 6, [Lam99]). *Given z, s_k , with $k \in \mathbb{Z}$ specified elements in $R = \mathbb{Z}[q^{\pm 1}]$, there exists a unique linear Markov trace function*

$$\text{tr} : \bigcup_{n=1}^{\infty} H_{1,n}(q) \rightarrow R(z, s_k), k \in \mathbb{Z}$$

determined by the rules:

- (1) $\text{tr}(ab) = \text{tr}(ba)$ for $a, b \in H_{1,n}(q)$
- (2) $\text{tr}(1) = 1$ for all $H_{1,n}(q)$
- (3) $\text{tr}(ag_n) = z\text{tr}(a)$ for $a \in H_{1,n}(q)$
- (4) $\text{tr}(at_n^k) = s_k \text{tr}(a)$ for $a \in H_{1,n}(q)$, $k \in \mathbb{Z}$.

Note that, if a word does not contain any t'_i 's, tr coincides with the Ocneanu trace. Using tr Lambropoulou constructed a universal Homflypt-type invariant for oriented links in ST. Namely, let \mathcal{L} denote the set of oriented links in S.T. Then:

Theorem 1.10 (Definition 1, [Lam99]). *The function $X : \mathcal{L} \rightarrow R(z, s_k)$*

$$X_{\hat{\alpha}} = \left[-\frac{1 - \lambda q}{\sqrt{\lambda}(1 - q)} \right]^{n-1} (\sqrt{\lambda})^e \text{tr}(\pi(\alpha)),$$

where $\alpha \in B_{1,n}$ is a word in the σ_i 's and t_i 's, e is the exponent sum of the σ_i 's in α , and π the canonical map of $B_{1,n}$ in $H_{1,n}(q)$, such that $t \mapsto t$ and $\sigma_i \mapsto g_i$, is an invariant of oriented links in ST.

The invariant X satisfies a skein relation [Lam94]. Theorems 1.8, 1.9 and 1.10 hold also for the algebras $H_n(q, Q)$ and $H_n(q, d)$, giving rise to all possible Homflypt-type invariants for knots in ST. For the case of the Hecke algebra of type B, $H_n(q, Q)$, see also [Lam94] and [LG97].

1.6 Knots in manifolds obtained by integral surgery

Let L be an oriented link in M . Fixing \widehat{B} pointwise, L can be represented unambiguously by a *mixed link* in S^3 denoted $\widehat{B} \cup L$, that is, a link in S^3 consisting of the *fixed part* \widehat{B} and the *moving part* L that links with \widehat{B} . A *mixed link diagram* is a diagram $\widehat{B} \cup \widetilde{L}$ of $\widehat{B} \cup L$ on the plane of \widehat{B} , where this plane is equipped with the top-to-bottom direction of the braid B .

1.6.1 The Reidemeister Theorem for links in 3-manifolds with integral surgery description

An isotopy of L in M can be translated into a finite sequence of moves of the mixed link $\widehat{B} \cup L$ in S^3 as follows. As we know, surgery along \widehat{B} is realized by taking first the complement $S^3 \setminus \widehat{B}$ and then attaching to it solid tori according to the surgery description. Thus, isotopy in M can be viewed as certain moves in S^3 , namely, isotopy in $S^3 \setminus \widehat{B}$ together with the band moves in S^3 , which are similar to the second Kirby move. Isotopy in $S^3 \setminus \widehat{B}$ is realized by the classical Reidemeister moves and planar moves for the moving part together with the *extended Reidemeister moves*. These are the Reidemeister II and III moves involving the fixed and the moving part of the mixed link (cf. Definition 5.1 [LR97]). A *band move* is a non-isotopy move in $S^3 \setminus \widehat{B}$ that reflects isotopy in M and is the band connected sum of a component, say s , of L with the specified (from the framing) parallel curve l of a surgery component, say c , of \widehat{B} . Note that l bounds a disc in M . There are two types of band moves according to the orientations of the component s of L and of the surgery curve c , as illustrated and exemplified in Figure 1.12. In the α -type the orientation of s is opposite to the orientation of c (and of its parallel curve l), but after the performance of the move their orientations agree. In the β -type the orientation of s agrees initially with the orientation of c , but disagrees after the performance of the move. Note that the two types of band moves are related by a twist of s (Reidemeister I move in $S^3 \setminus \widehat{B}$).

The above are summarized in the following analogue of the Reidemeister theorem for oriented links in M .

Theorem 1.11 (Reidemeister for $M = \chi_z(S^3, \widehat{B})$, Thm. 5.8 [LR97]). *Two oriented links L_1, L_2 in $M = \chi_z(S^3, \widehat{B})$ are isotopic if and only if any two corresponding mixed link diagrams of theirs, $\widehat{B} \cup \widetilde{L}_1$ and $\widehat{B} \cup \widetilde{L}_2$, differ by isotopy in $S^3 \setminus \widehat{B}$ together with a finite sequence of the two types α and β of band moves.*

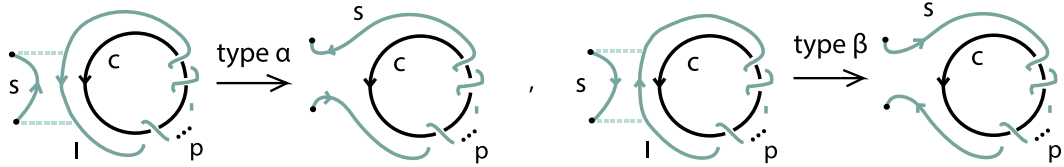

Fig. 1.12: The two types of \mathbb{Z} -band moves.

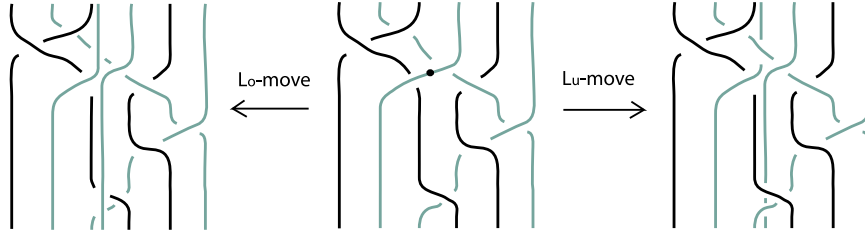

Fig. 1.13: A geometric mixed braid and the two types of L -moves.

1.6.2 Geometric mixed braids and the L -moves

In order to translate isotopy of links in the 3-manifold M to braid equivalence, we need to introduce the notion of a geometric mixed braid. A *geometric mixed braid* related to $M = \chi_{\mathbb{Z}}(S^3, \hat{B})$ and to a link K in M , is an element of the group B_{m+n} , where m strands form the fixed *surgery braid* B and n strands form the *moving subbraid* β representing the link K in M . For an illustration see the middle picture of Figure 1.13. We further need the notions of the L -moves and the braid band moves.

Definition 1.7 (L -moves and \mathbb{Z} -braid band moves, Definitions 2.1 and 5.6 [LR97]).

(i) Let $B \cup \beta$ be a geometric mixed braid in S^3 and P a point of an arc of the moving subbraid β , such that P is not vertically aligned with any crossing or endpoint of a braid strand. Doing an L -move at P means to cut the arc at P , to bend the two resulting smaller arcs slightly apart by a small isotopy and to stretch them vertically, the upper downward and the lower upward, and both *over* or *under* all other arcs of the diagram, so as to introduce two new corresponding moving strands with endpoints on the vertical line of the point P . Stretching the new strands over will give rise to an L_o -move and under to an L_u -move. For an illustration see Figure 1.13. Two geometric mixed braids shall be called L -equivalent if and only if they differ by a sequence of L -moves and braid isotopy.

(ii) A *geometric \mathbb{Z} -braid band move* is a move between geometric mixed braids which is a band move between their closures. It starts with a little band oriented downward, which, before sliding along a surgery strand, gets one twist *positive* or *negative* (see Figure 1.14 (a) and (b)).

Remark 1.2. (i) In [LR97] it is shown that classical braid equivalence in S^3 is generated only by the L -moves. This implies that braid conjugation and in particular change of

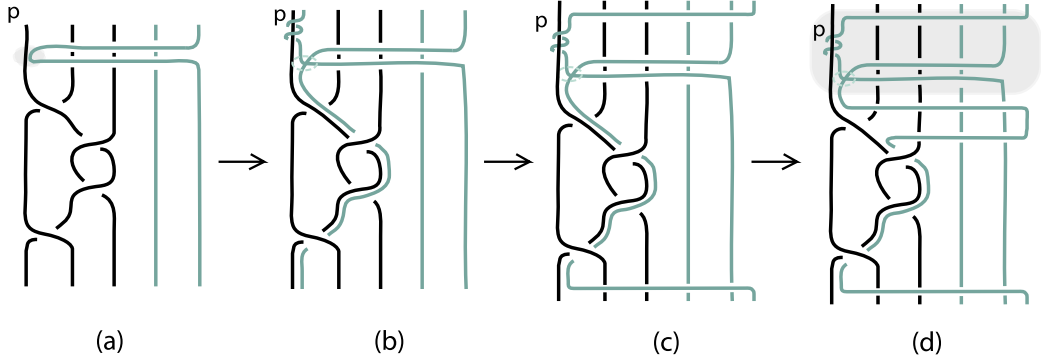

Fig. 1.14: A geometric, a parted and an algebraic \mathbb{Z} -braid band move (top part of (d)).

the order of the endpoints of a braid can be realized by L -moves. A demonstration can be found in [LR06] Figure 14.

(ii) A geometric \mathbb{Z} -braid band move may be always assumed, up to L -equivalence, to take place at the top part of a mixed braid and on the right of the specific surgery strand ([LR06] Lemma 5).

In [LR97] the following theorem was proved for isotopic links in $M = \chi_{\mathbb{Z}}(S^3, \widehat{B})$.

Theorem 1.12 (Geometric braid equivalence for $M = \chi_{\mathbb{Z}}(S^3, \widehat{B})$, Theorem 5.10 [LR97]). *Two oriented links in $M = \chi_{\mathbb{Z}}(S^3, \widehat{B})$ are isotopic if and only if any two corresponding geometric mixed braids in S^3 differ by mixed braid isotopy, by L -moves that do not touch the fixed subbraid B and by the geometric \mathbb{Z} -braid band moves.*

1.6.3 Algebraic mixed braids and their equivalence

Let $M = \chi_{\mathbb{Z}}(S^3, \widehat{B})$. We will pass from the geometric braid equivalence to an algebraic statement for links in M . An *algebraic mixed braid* is a mixed braid on $m + n$ strands such that the first m strands are fixed and form the identity braid on m strands and the next n strands are moving strands and represent a link in the manifold M . The set of all algebraic mixed braids on $m + n$ strands forms a subgroup of B_{m+n} , denoted $B_{m,n}$, and called *mixed braid group*. In [La2] the mixed braid groups $B_{m,n}$ have been introduced and studied and it is shown that $B_{m,n}$ has the presentation:

$$B_{m,n} = \left\langle \begin{array}{l} a_1, \dots, a_m, \\ \sigma_1, \dots, \sigma_{n-1} \end{array} \left| \begin{array}{l} \sigma_k \sigma_j = \sigma_j \sigma_k, \quad |k - j| > 1 \\ \sigma_k \sigma_{k+1} \sigma_k = \sigma_{k+1} \sigma_k \sigma_{k+1}, \quad 1 \leq k \leq n - 1 \\ a_i \sigma_k = \sigma_k a_i, \quad k \geq 2, \quad 1 \leq i \leq m \\ a_i \sigma_1 a_i \sigma_1 = \sigma_1 a_i \sigma_1 a_i, \quad 1 \leq i \leq m \\ a_i (\sigma_1 a_r \sigma_1^{-1}) = (\sigma_1 a_r \sigma_1^{-1}) a_i, \quad r < i \end{array} \right. \right\rangle, \quad (1.3)$$

where the *loop generators* a_i and the *braiding generators* σ_j are as illustrated in Figure 1.15.

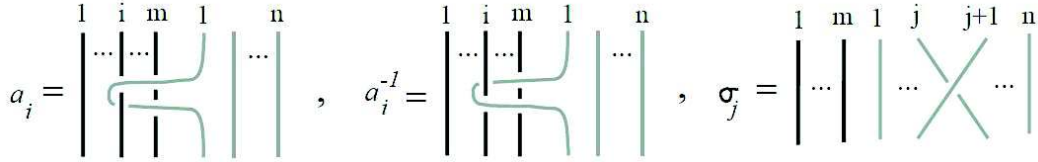

Fig. 1.15: The loop generators a_i , a_i^{-1} and the braiding generators σ_j of $B_{m,n}$.

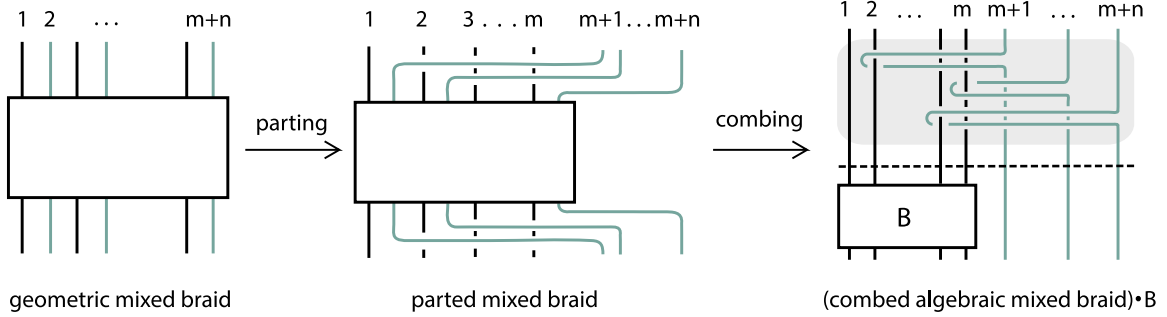

Fig. 1.16: Parting and combing a geometric mixed braid.

In order to give an algebraic statement for braid equivalence in M , we first part the mixed braids and we translate the geometric L -equivalence of Theorem 1.12 to an equivalence of parted mixed braids. *Parting* a geometric mixed braid $B \cup \beta$ on $m+n$ strands means to separate its endpoints into two different sets, the first m belonging to the subbraid B and the last n to β , and so that the resulting braids have isotopic closures. This is realized by pulling each pair of corresponding moving strands to the right and *over* or *under* each strand of B that lies on their right. We start from the rightmost pair respecting the position of the endpoints. This process is called *parting* of a geometric mixed braid and the result is a *parted mixed braid*. If the strands are pulled always over the strands of B , then this parting is called *standard parting*. See the middle illustration of Figure 1.16 for the standard parting of an abstract mixed braid. For more details the reader is referred to [LR06].

Then, in order to restrict Theorem 1.12 to the set of all parted mixed braids related to the manifold M , we need the following moves between parted mixed braids. *Loop conjugation* of a parted mixed braid β is its concatenation by a loop a_i (or by a_i^{-1}) from above and from a_i^{-1} (corr. a_i) from below, that is $\beta \sim a^{\pm 1} \beta a^{\mp 1}$. As it turns out, two partings of a geometric mixed braid differ by loop conjugations (cf. Lemma 2 [LR06]). A *parted L -move* is an L -move between parted mixed braids. Further, a mixed braid with an L -move performed can be parted to a parted mixed braid with a parted L -move performed. Namely we make the parting consistent with the label of the L -move: an L_o move will be parted by pulling over all other strands, while an L_u move will be parted by pulling under all other strands (cf. Lemma 3 [LR06]). A *parted \mathbb{Z} -braid band move* is a geometric \mathbb{Z} -braid band move between parted mixed braids, such that it takes place

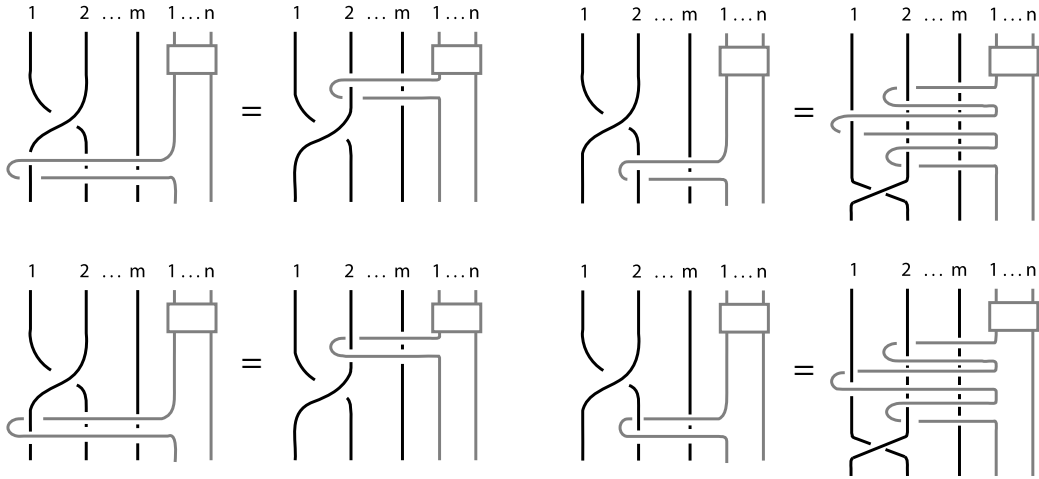

Fig. 1.17: Combing a parted mixed braid.

at the top part of the braid and the little band *starts from the last strand* of the moving subbraid and it *moves over* each moving strand and each component of the surgery braid, until it reaches from the right the specific component, and then is followed by parting (see Figure 1.14(c)). Moreover, performing a \mathbb{Z} -braid band move on a mixed braid and then parting, the result is equivalent, up to L -moves and loop conjugation, to performing a parted \mathbb{Z} -braid band move (cf. Lemma 5 [LR06]).

Theorem 1.13 (Parted mixed braid equivalence for $M = \chi_{\mathbb{Z}}(S^3, \widehat{B})$, Theorem 3 [LR06]). *Two oriented links in $M = \chi_{\mathbb{Z}}(S^3, \widehat{B})$ are isotopic if and only if any two corresponding parted mixed braids differ by a finite sequence of parted mixed braid isotopies, parted L -moves, loop conjugations and parted \mathbb{Z} -braid band moves.*

We now comb the parted mixed braids in order to translate the parted mixed braid equivalence to an equivalence between algebraic mixed braids. *Combing* a parted mixed braid means to separate the knotting and linking of the moving part away from the fixed subbraid using mixed braid isotopy. More precisely, let Σ_k denote the crossing between the k^{th} and the $(k+1)^{\text{st}}$ strand of the fixed subbraid. Then, for all $j = 1, \dots, n-1$ and $k = 1, \dots, m-1$ we have: $\Sigma_k \sigma_j = \sigma_j \Sigma_k$. Thus, the only generating elements of the moving part that are affected by the combing are the loops a_i . This is illustrated in Figure 1.17. In Lemma 6 [LR06] formulæ are given for the effect of combing on the a_i 's (see Lemma 2.2 below).

The effect of combing a parted mixed braid is to separate it into two distinct parts: the *algebraic part* at the top, which has all fixed strands forming the identity braid, so is an element of some mixed braid group $B_{m,n}$, and which contains all the knotting and linking information of the link L in M ; the *coset part* at the bottom, which contains only the fixed subbraid B and an identity braid for the moving part (see right hand most illustration in Figure 1.16). Let now $C_{m,n}$ denote the set of parted mixed braids on n moving strands with fixed subbraid B . Concatenating two elements of $C_{m,n}$ is not

a closed operation since it alters the braid description of the manifold. However, as a result of the combing, for the fixed subbraid B the set $C_{m,n}$ is a coset of $B_{m,n}$ in B_{m+n} . For details on the above the reader is referred to [Lam99].

Translating the parted braid equivalence into an equivalence between algebraic mixed braids, we will obtain an algebraic statement of Theorem 1.13. Since loop conjugation does not take into account the combing of the loop through the fixed subbraid, we need the notion of *combed loop conjugation*. A combed loop conjugation is a move between algebraic mixed braids and is the result of a loop conjugation on a combed mixed braid followed by combing, so it can be described algebraically as: $\beta \sim \alpha_i^{\mp 1} \beta \rho_i^{\pm 1}$ for $\beta, \alpha_i, \rho_i \in B_{m,n}$, where ρ_i is the combing of the loop α_i through the fixed subbraid B . We also define *algebraic M-conjugation* of an algebraic mixed braid to be its conjugation by a crossing σ_j (or by σ_j^{-1}). An *algebraic M-move* is defined to be the insertion of a crossing $\sigma_n^{\pm 1}$ on the right hand side of an algebraic mixed braid. Finally, an *algebraic L-move* is defined to be a L -move between algebraic mixed braids. An algebraic L -move has the following algebraic expression for an L_o -move and an L_u -move respectively:

$$\begin{aligned} \alpha &= \alpha_1 \alpha_2 \stackrel{L_o}{\sim} \sigma_i^{-1} \dots \sigma_n^{-1} \alpha'_1 \sigma_{i-1}^{-1} \dots \sigma_{n-1}^{-1} \sigma_n^{\pm 1} \sigma_{n-1} \dots \sigma_i \alpha'_2 \sigma_n \dots \sigma_i \\ \alpha &= \alpha_1 \alpha_2 \stackrel{L_u}{\sim} \sigma_i \dots \sigma_n \alpha'_1 \sigma_{i-1} \dots \sigma_{n-1} \sigma_n^{\pm 1} \sigma_{n-1}^{-1} \dots \sigma_i^{-1} \alpha'_2 \sigma_n^{-1} \dots \sigma_i^{-1} \end{aligned} \quad (1.4)$$

where α_1, α_2 are elements of $B_{m,n}$ and $\alpha'_1, \alpha'_2 \in B_{m,n+1}$ are obtained from α_1, α_2 by replacing each σ_j by σ_{j+1} for $j = i, \dots, n-1$.

Note that algebraic M -conjugation, the algebraic M -moves and the algebraic L -moves commute with combing. Note also that Remark 1.2(i) applies equally to the case of algebraic mixed braids (cf. Lemma 4 [LR06]).

We finally need to understand how a parted \mathbb{Z} -braid band move is combed through the surgery braid B .

Definition 1.8 (Definition 7 [LR06]). An *algebraic \mathbb{Z} -braid band move* is defined to be a parted band move between algebraic mixed braids (see top part of Figure 1.14(d)). Setting:

$$\lambda_{n-1,1} := \sigma_{n-1} \dots \sigma_1 \quad \text{and} \quad t_{k,n} := \sigma_n \dots \sigma_1 a_k \sigma_1^{-1} \dots \sigma_n^{-1},$$

an algebraic band move has the following algebraic expression:

$$\beta_1 \beta_2 \sim \beta'_1 t_{k,n}^{p_k} \sigma_n^{\pm 1} \beta'_2,$$

where $\beta_1, \beta_2 \in B_{m,n}$ and $\beta'_1, \beta'_2 \in B_{m,n+1}$ are the words β_1, β_2 respectively with the substitutions:

$$\begin{aligned} a_k^{\pm 1} &\longleftrightarrow [(\lambda_{n-1,1}^{-1} \sigma_n^2 \lambda_{n-1,1}) a_k]^{\pm 1} \\ a_i^{\pm 1} &\longleftrightarrow (\lambda_{n-1,1}^{-1} \sigma_n^2 \lambda_{n-1,1}) a_i^{\pm 1} (\lambda_{n-1,1}^{-1} \sigma_n^2 \lambda_{n-1,1}), \quad \text{if } i < k \\ a_i^{\pm 1} &\longleftrightarrow a_i^{\pm 1}, \quad \text{if } i > k. \end{aligned}$$

Further, a *combed algebraic \mathbb{Z} -braid band move* is a move between algebraic mixed braids and is defined to be a parted \mathbb{Z} -braid band move that has been combed through B . So it is the composition of an algebraic \mathbb{Z} -braid band move with the combing of the

parallel strand and it has the following algebraic expression:

$$\beta_1\beta_2 \sim \beta'_1 t_{k,n}^{p_k} \sigma_n^{\pm 1} \beta'_2 r_k,$$

where r_k is the combing of the parted parallel strand to the k^{th} surgery strand through the surgery braid.

The group $B_{m,n}$ embeds naturally into the group $B_{m,n+1}$. We shall denote $B_{m,\infty} = \bigcup_{n=1}^{\infty} B_{m,n}$ and similarly $C_{m,\infty} = \bigcup_{n=1}^{\infty} C_{m,n}$.

We are now in position to give the algebraic Markov theorem for $M = \chi_z(S^3, \widehat{B})$.

Theorem 1.14 (Algebraic Markov Theorem for $M = \chi_z(S^3, \widehat{B})$, Theorem 5 [LR06]).
Two oriented links in $M = \chi_z(S^3, \widehat{B})$ are isotopic if and only if any two corresponding algebraic mixed braid representatives in $B_{m,\infty}$ differ by a finite sequence of the following moves:

- (1) *Algebraic M-moves:* $\beta_1\beta_2 \sim \beta_1\sigma_n^{\pm 1}\beta_2$, for $\beta_1, \beta_2 \in B_{m,n}$,
- (2) *Algebraic M-conjugation:* $\beta \sim \sigma_j^{\pm 1}\beta\sigma_j^{\mp 1}$, for $\beta, \sigma_j \in B_{m,n}$,
- (3) *Combed loop conjugation:* $\beta \sim a_i^{\mp 1}\beta\rho_i^{\pm 1}$, for $\beta, a_i, \rho_i \in B_{m,n}$, where ρ_i is the combing of the loop a_i through B ,
- (4) *Combed algebraic braid band moves:* For every $k = 1, \dots, m$ we have:

$$\beta_1\beta_2 \sim \beta'_1 t_{k,n}^{p_k} \sigma_n^{\pm 1} \beta'_2 r_k,$$

where $\beta_1, \beta_2 \in B_{m,n}$ and $\beta'_1, \beta'_2 \in B_{m,n+1}$ are as in Definition 1.8 and where r_k is the combing of the parted parallel strand to the k th surgery strand through B .

Equivalently, by a finite sequence of algebraic mixed braid relations and the following moves:

- (1') *algebraic L-moves,*
- (2') *combed loop conjugations,*
- (3') *combed algebraic \mathbb{Z} -braid band moves.*

1.7 Homflypt Skein Modules

Definition 1.9. A 3-manifold M^3 is a compact, connected, Hausdorff space M each point of which has a neighborhood homeomorphic to \mathbb{R}^3 . A 3-manifold with boundary is defined similarly, except that besides neighborhoods homeomorphic to \mathbb{R}^3 , neighborhoods homeomorphic to $\mathbb{R}_+^3 := \{(x, y, z) \in \mathbb{R}^3 \mid z \geq 0\}$ are also allowed. The set of points that have only neighborhoods of the second type is called boundary of M^3 and is denoted by ∂M^3 . A compact 3-manifold with no boundary is said to be *closed*.

where the finite group \mathbb{Z}_p acts freely on S^3 :

A skein module of a 3-manifold M is a module associated to M by considering all linear combinations of links in M , modulo some properly chosen skein relation.

Let M be an oriented 3-manifold, $R = \mathbb{Z}[u^{\pm 1}, z^{\pm 1}]$, \mathcal{L} the set of all oriented links in M up to ambient isotopy in M and let S the submodule of $R\mathcal{L}$ generated by the skein expressions $u^{-1}L_+ - uL_- - zL_0$, where L_+ , L_- and L_0 are oriented links that have identical diagrams, except in one crossing, where they are as depicted in Figure 1.18.

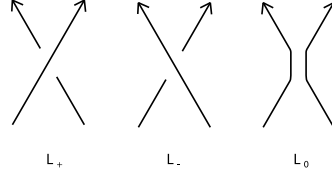

Fig. 1.18: The links L_+ , L_- , L_0 locally.

For convenience we allow the empty knot, \emptyset , and add the relation $u^{-1}\emptyset - u\emptyset = zT_1$, where T_1 denotes the trivial knot. Then the *Homflypt skein module* of M is defined to be:

$$S(M) = \mathcal{S}(M; \mathbb{Z}[u^{\pm 1}, z^{\pm 1}], u^{-1}L_+ - uL_- - zL_0) = R\mathcal{L}/S.$$

Unlike the Kauffman bracket skein module, the Homflypt skein module of a 3-manifold, also known as *Conway skein module* and as *third skein module*, is very hard to compute.

The linear dimension of $S(M)$ means the number of independent Homflypt-type invariants defined on knots in M . For example, the Homflypt skein module of S^3 is freely generated by the unknot (Homflypt polynomial) and the Homflypt skein module of the solid torus is generated by elements of the set $t'_{i_1}{}^{\varepsilon_1} \widehat{t'_{i_2}{}^{\varepsilon_2}} \dots t'_{i_n}{}^{\varepsilon_n}$, $n \in \mathbb{N}$, $\varepsilon_i \in \mathbb{Z}$, where $t'_{i_k}{}^{\varepsilon_k}$ are shown below.

Equivalently, $S(M)$ means the set of independent Markov traces defined on the quotient algebra: $S(M) = \frac{\text{CBraids of } M}{\text{Markov Equivalence}}_{g_i^2 = (q-1)g_i + q}$.

Let us now see how $S(\text{ST})$ is described in the above algebraic language. We note first that an element α in the basis of $S(\text{ST})$ described in Theorem 3.1 when ST is considered as $\text{Annulus} \times \text{Interval}$, can be illustrated equivalently as a mixed link in S^3 when ST is viewed as the complement of a solid torus in S^3 . So we correspond the element α to the minimal mixed braid representation, which has decreasing order of twists around the fixed strand. Figure 1.19 illustrates an example of this correspondence. Denoting

$$\Lambda' = \{t_1^{k_1} t_2^{k_2} \dots t_n^{k_n}, k_i \in \mathbb{Z} \setminus \{0\}, k_{i+1} \geq k_i, \forall i, n \in \mathbb{N}\}, \quad (1.5)$$

we have that Λ' is a subset of $\bigcup_n H_{1,n}$. In particular Λ' is a subset of $\bigcup_n \Sigma'_n$.

Applying the inductive trace rules to a word w in $\bigcup_n \Sigma'_n$ will eventually give rise to linear combinations of monomials in $\mathbb{Z}[q^{\pm 1}, z]$. In particular, for an element of Λ' we have:

$$\text{tr}(t_1^{k_0} t_1^{k_1} \dots t_{n-1}^{k_{n-1}}) = s_{k_{n-1}} \dots s_{k_1} s_{k_0}.$$

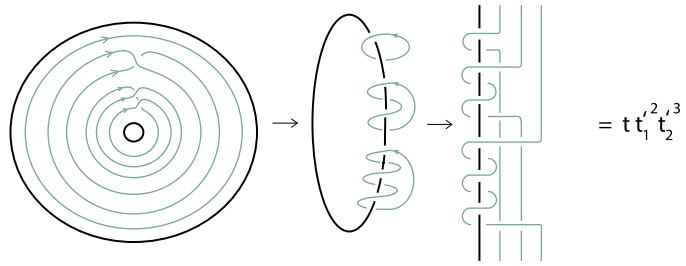

Fig. 1.19: An element of Λ' .

Further, the elements of Λ' are in bijective correspondence with increasing n -tuples of integers, $(k_0, k_1, \dots, k_{n-1})$, $n \in \mathbb{N}$, and these are in bijective correspondence with monomials in $s_{k_0}, s_{k_1}, \dots, s_{k_{n-1}}$.

Remark 1.3. The invariant X recovers the Homflypt skein module of ST since it gives different values for different elements of Λ' by rule 4 of the trace.

BRAID EQUIVALENCE IN 3-MANIFOLDS WITH RATIONAL SURGERY DESCRIPTION

In this chapter we provide algebraic mixed braid classification of links in any c.c.o. 3-manifold M obtained by rational surgery along a framed link in S^3 . We do this by representing M by a closed framed braid in S^3 and links in M by closed mixed braids in S^3 . We first prove an analogue of the Reidemeister theorem for links in M . We then give geometric formulations of the mixed braid equivalence using the L -moves and the braid band moves. Finally we formulate the algebraic braid equivalence in terms of the mixed braid groups $B_{m,n}$, using cabling and the parting and combing techniques for mixed braids. Our results set a homogeneous algebraic ground for studying links in 3-manifolds and in families of 3-manifolds using computational tools. We provide concrete formulæ of the braid equivalences in lens spaces, in Seifert manifolds, in homology spheres obtained from the trefoil and in manifolds obtained from torus knots.

Our setting is appropriate for constructing Jones-type invariants for links in families of 3-manifolds via quotient algebras of the mixed braid groups $B_{m,n}$, as well as for studying skein modules of 3-manifolds, since they provide a controlled algebraic framework and much of the diagrammatic complexity has been absorbed into the proofs. Further, our moves can be used in a braid analogue of Rolfsen's rational calculus and potentially in computing Witten invariants.

2.1 Introduction

In the study of knots and links in 3-manifolds, such as handlebodies, knot complements, closed, connected, oriented (c.c.o.) 3-manifolds, as well as in the study of 3-manifolds themselves, it can prove very useful to take an approach via braids, as the use of braids provides more structure and more control on the topological equivalence moves. After the construction of the Jones polynomial for links in S^3 , many mathematicians focused on expressing link isotopy in oriented 3-manifolds via appropriate braids, using different approaches, cf. for example [Sko91, Sko92], [Sun91, Sun93], [Sos92], [LR97, Lam94,

LR06, OL02].

In [LR97] braid equivalences have been obtained for isotopy of knots and links in knot complements and in c.c.o. 3-manifolds with integral surgery description. Integral surgery covers the generality, since every c.c.o. 3-manifold can be constructed via integral surgery along a framed link in S^3 , the components of which may be assumed to be simple closed curves, giving rise to a closed framed pure braid. So, for a 3-manifold, say M , a surgery description via a closed framed braid \widehat{B} in S^3 is fixed and we write $M = \chi(S^3, \widehat{B})$. Then, links in M can be represented unambiguously by *mixed links* in S^3 (see Figure 1.8 and Figure 1.13), that is, links in S^3 that contain \widehat{B} as a fixed sublink. Mixed links are then represented by geometric *mixed braids* which contain B as a fixed subbraid. Link isotopy in M comprises isotopy in the complement $S^3 \setminus \widehat{B}$ together with the *band moves*, which come from the handle sliding moves in M according to the surgery description of M (see Figure 1.12). Isotopy in M is then translated into mixed link equivalence. For obtaining the geometric mixed braid equivalences in M , the authors sharpened first the classic Markov theorem giving only one type of equivalence moves, the *L-moves* (see Figure 1.13), which are geometric as well as algebraic. Then, it was proved that link isotopy in M is generated by the *L-moves* and the *braid band moves* (see Figure 1.14). Further, in [LR06] the geometric statements were reformulated into algebraic language, via the cosets of the braid B in the *mixed braid groups* $B_{m,n}$ (see (1.3) and Figure 1.15), introduced and studied in [Lam94], and the techniques of parting and combing mixed braids (see Figure 1.16). *Parting* a geometric mixed braid means to separate its strands into two sets: the strands of the fixed subbraid B and the ‘moving strands’ of the braid representing a link in M . *Combing* a parted mixed braid means to separate the braiding of the fixed subbraid B from the braiding of the moving strands (see Figures 1.14 and 1.17). The above techniques have been also applied for obtaining mixed braid equivalences in knot complements and in handlebodies [LR06, OL02] (see also [Sos92]).

Integral surgery is a special case of rational surgery. There are c.c.o. 3-manifolds which have simpler description when obtained from S^3 via rational surgery. There are even whole families of 3-manifolds described by rational surgery along the same link. Representative examples are the lens spaces $L(p, q)$: they are all obtained from the trivial knot with rational surgery description p/q , while with integral surgery description different, non-trivial links are needed, see for example [Rol76]. Another important example comprise the homology spheres obtained by rational surgery $1/n$ along the trefoil knot: with integral surgery they would be described by more complicated knots (see [Rol84]). Other known classes of 3-manifolds given by the same surgery description (with different surgery coefficients) comprise the Seifert manifolds ([Sav99]) and manifolds obtained by surgery along torus knots ([Mos71]). We note that a whole family of 3-manifolds described by different framings on the same link, in our setting is represented by the same cosets of the mixed braid groups $B_{m,n}$.

The purpose of this chapter is to provide mixed braid equivalences, geometric as well as algebraic, for isotopy of oriented links in families of c.c.o. 3-manifolds obtained by rational surgery along framed links in S^3 . A simpler surgery description of a c.c.o. 3-manifold M is expected to induce simpler algebraic expressions for the braid equivalence

in M . As an example, compare [LR06, §4] with §2.7.2 in this paper for the case of lens spaces: in this paper the \mathbb{Q} -mixed braid equivalence is in the mixed braid groups $B_{1,n}$ and there is only one expression for the braid band moves, while in [LR06] there are many, according to the integer surgery coefficient of each strand of the surgery pure braid; on top of that combing is also needed. Further, in §2.7 we give the algebraic \mathbb{Q} -mixed braid equivalences for links in all four families of 3-manifolds mentioned above. In the paper we use the setting and the results of [LR97, LR06] and our results extend the results of [LR97, LR06] to rational surgery descriptions and to arbitrary framed braids. We first formulate the geometric \mathbb{Q} -mixed braid equivalence via the L -moves and the braid band moves and then we move gradually to the algebraic statement by introducing the notion of cabling and applying the parting and combing techniques of [LR06].

More precisely: let M be a c.c.o. 3-manifold obtained by rational surgery along a framed link \widehat{B} in S^3 . Note that the surgery braid B is not assumed to be a pure braid. Let s be a surgery component of B with surgery description p/q consisting of k strands, s_1, \dots, s_k . When a *geometric \mathbb{Q} -braid band move* on s occurs, k sets of q new strands appear, each one running in parallel to a strand of s , and also a (p, q) -torus braid d' wraps around the last strand, s_k , p times, followed by a positive or negative crossing c'_\pm , see Figures 2.10 (shaded region) and 2.7. These moves together with the L -moves lead to the *geometric \mathbb{Q} -mixed braid equivalence* in M (Theorem 2.3) (see also [LR97, Sko92, Sun93]). The \mathbb{Q} -braid band moves are clearly much more complicated than the \mathbb{Z} -braid band moves in [LR97]. However, a sharpened version of the Reidemeister theorem for links in M (Theorem 2.2; see also [LR97, Sko91, Sun91]), whereby only one type of band moves is used in the mixed link isotopy (see Figure 2.1), makes the proof of Theorem 2.3 quite light.

In order to move toward an algebraic statement we adapt the techniques and results of [LR06] using the notion of a *q -strand cable*. A q -strand cable represents a set of q new strands arising from the performance of a geometric braid band move. So, we show first that standard parting of a q -strand cable is equivalent to standard parting of each strand of the cable one by one; in other words that parting and cabling commute. Treating now each one of the k q -strand cables as one thickened strand leads to the *parted \mathbb{Q} -mixed braid equivalence* (Theorem 2.4), assuming the corresponding result with integral surgery from [LR06]. We continue by finding algebraic expressions for the loopings of the cables around the fixed strands of B (Lemma 2.3). Then, after a parted \mathbb{Q} -braid band move is performed (Figure 2.20a), we part locally the (p, q) -torus braid d' , the crossing c'_\pm and the loop generators a_j between the moving and the fixed strands obtaining their corresponding algebraic expressions (see Figures 2.17, 2.18, 2.19 and Definition 6(i)). In this way we obtain the algebraic expression of an *algebraic \mathbb{Q} -braid band move*, which takes place on elements of the braid groups $B_{m,n}$ (see top part of Figure 2.20b) and Definition 2.4(i)). Finally, we do combing through the fixed subbraid B and we show that combing and cabling commute (see Figures 2.14 to 2.16). After the combing our parted mixed braids as well as the \mathbb{Q} -braid band moves get separated from the fixed subbraid B , having picked information from it. So, we obtain the *algebraic \mathbb{Q} -mixed braid equivalence* for links in M in terms of the mixed braid groups $B_{m,n}$ and this is our

main result (Theorem 2.5). Further, in §2.7.2–§2.7.5 we apply Theorem 2.5 to give the concrete algebraic expressions for the \mathbb{Q} -mixed braid equivalences in the aforementioned families of 3-manifolds.

Our results set a homogeneous algebraic ground for studying links in families of 3-manifolds with the computational advantage. Indeed, as we discuss in §2.7.6, our setting is the right one for constructing *Jones type invariants* (such as analogues of the Jones polynomial and the 2-variable Jones or Homflypt polynomial) for links in 3-manifolds via appropriate quotient algebras of the mixed braid groups $B_{m,n}$ (such as analogues of the Temperley-Lieb algebras and the Iwahori-Hecke algebras) which support Markov traces. This topological motivation gives rise to new algebras worth studying. Then one can derive link invariants in the complement $S^3 \setminus \widehat{B}$, which then have to satisfy all possible band moves, for extending them to link invariants in the manifold $M = \chi(S^3, \widehat{B})$. Our results can be equally applied to the study of *skein modules* of c.c.o. 3-manifolds, using braid techniques (see §2.7.6). The advantage of the braid approach is that the algebraic mixed braid equivalences provide good control over the band moves, better than in the diagrammatic setting, and much of the diagrammatic complexity is absorbed into the proofs of the algebraic statements. We only need to consider one type of orientations patterns and the braid band moves are limited. A good example and the simplest one demonstrating the above is the case of the lens spaces $L(p, 1)$: in [Lam99] a generic analogue of the Homflypt polynomial for links in the solid torus, ST, has been defined from the generalized Hecke algebras of type B via a Markov trace constructed on them. This invariant recovers the Homflypt skein module of ST. In order to extend this to an invariant of links in $L(p, 1)$ in Chapter 3 we solve an infinite system of equations resulting from the braid band moves and we show that it has a unique solution, which proves the freeness of the module. In [GM14] the same problem has been solved using the diagrammatic approach. Finally, our \mathbb{Q} -braid band move can be used for providing a braid analogue of the Rational calculus, which is Rolfsen’s analogue to the Kirby calculus for manifolds with rational surgery description [Rol84], extending the braid approach to the Kirby calculus by Ko and Smolinsky [KS92] (see §2.7.7). Then, our results can potentially lead to a braid computational approach to the Witten invariants.

This chapter is organized as follows. In §2.2 we prove the sharpened version of the Reidemeister theorem for knots and links in c.c.o. 3-manifolds with rational surgery description (Theorem 2.2). In §2.3 we derive the geometric \mathbb{Q} -mixed braid equivalence for links in such 3-manifolds (Theorem 2.3) and we introduce the cabling. In §2.4 we derive the parted \mathbb{Q} -mixed braid equivalence using the cabling and in §2.5 we show that combing and cabling commute. These lead to §2.6 where we give the algebraic \mathbb{Q} -mixed braid equivalence (Theorem 2.5). In §2.7.2–§2.7.5 the reader will find the application of Theorem 2.5 to the aforementioned families of 3-manifolds. In §2.7.6 we discuss applications to Jones-type invariants of links in 3-manifolds and to skein modules of 3-manifolds; finally, in §2.7.7 we discuss the potential application to formulating Rolfsen’s Rational Calculus in terms of braids and to the computation of the Witten invariants.



Fig. 2.1: The two types of \mathbb{Q} -band moves.

2.2 The Reidemeister Theorem for links in 3-manifolds

>From now on M will denote a c.c.o. 3-manifold obtained from S^3 by rational surgery, that is surgery along a framed link \widehat{B} with rational coefficients, denoted $M = \chi_{\mathbb{Q}}(S^3, \widehat{B})$. Let L be an oriented link in M . By the discussion in §1.6.1, isotopy in M is translated into isotopy in $S^3 \setminus \widehat{B}$ together with the two types, α and β , of band moves for mixed links in S^3 . The band moves in this case are described as follows. Let c be a component of \widehat{B} with framing p/q . The specified parallel curve l of c is a (p, q) -torus knot on the boundary of a tubular neighborhood of c which, by construction, bounds a disc in M . Then, a \mathbb{Q} -band move along c is the connected sum of a component of L with the (p, q) -torus knot l and there are two types, α and β , according to the orientations. The two types of band moves are illustrated in Figure 2.1, where c is a trefoil knot with $2/3$ surgery coefficient and where “band move” is shortened to “b.m.”. Clearly, Theorem 1.11 applies also to $M = \chi_{\mathbb{Q}}(S^3, \widehat{B})$. Namely:

Theorem 2.1 (Reidemeister for $M = \chi_{\mathbb{Q}}(S^3, \widehat{B})$ with two types of band moves). *Two oriented links L_1, L_2 in M are isotopic if and only if any two corresponding mixed link diagrams of theirs, $\widehat{B} \cup \widehat{L}_1$ and $\widehat{B} \cup \widehat{L}_2$, differ by isotopy in $S^3 \setminus \widehat{B}$ together with a finite sequence of the two types α and β of band moves.*

In this section we sharpen Theorem 2.1. More precisely, we show that only one of the two types of band moves is necessary in order to describe isotopy for links in M . The proof is based on a known contrivance, which was used in the proof of Theorem 5.10 [LR97] (Theorem 1.12) for establishing the sufficiency of the geometric braid band moves in the mixed braid equivalence for the case of integral surgery (see Figure 2.2). Theorem 2.2 simplifies the proof of Theorem 2.3.

Theorem 2.2 (Reidemeister for $M = \chi_{\mathbb{Q}}(S^3, \widehat{B})$ with one type of band moves). *Two oriented links L_1, L_2 in M are isotopic if and only if any two corresponding mixed link diagrams of theirs, $\widehat{B} \cup \widehat{L}_1$ and $\widehat{B} \cup \widehat{L}_2$, differ by a finite sequence of the band moves of type α (or equivalently of type β) and isotopy in $S^3 \setminus \widehat{B}$.*

Proof. Let L be an oriented link in M . By Theorem 2.1, it suffices to show that a band move of type β can be obtained from a band move of type α and isotopy in the knot complement. We will first demonstrate the proof for an unknotted surgery component

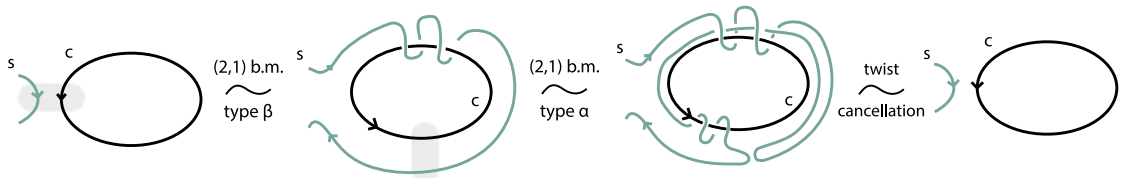

Fig. 2.2: A type- β band move follows from a type- α band move in the case of integral surgery coefficient.

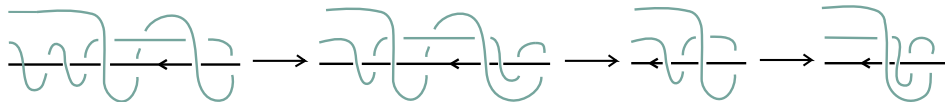

Fig. 2.3: Twist cancellation.

c with integral coefficient p . (Note that integral surgery description can be considered as a special case of rational surgery description.) We shall follow the steps of the proof in Figure 2.2 where $p = 2$. We start with performing a band move of type β using a component s of the link L . In Figure 2.2 we see the two twists of the band move wrapping around the surgery curve c in the righthand sense. Then, using an arc of the same link component s , we perform a second band move of type α . This will take place within a thinner tubular neighborhood than the first band move. So, the two twists of the second band move, which also wrap around c in the righthand sense, commute with the two twists of the first band move. We arrange all $2p$ twists in pairs as follows. We pass one twist from the second band move (the closest) through all twists of the first band move, see Figure 2.3. Since all twists follow the righthand sense, the two innermost twists coming from the second and the first band move, create a little band which can be eliminated using isotopy in the knot complement of c . This is the cancellation of the first pair of the $2p$ twists. Repeating the same procedure we cancel all p pairs and we end up with the component s of the link L as it was in the initial position before the band moves.

For the more general case of rational surgery along any knot c we follow the same idea. More precisely, we perform a \mathbb{Q} -band move of type β along c and we obtain an outer (p, q) -torus knot. Then, we perform a \mathbb{Q} -band move of type α along c and we obtain an inner (p, q) -torus knot. In Figure 2.4 we illustrate this for the case where $p = 2$, $q = 3$ and c a trefoil knot.

Without loss of generality (by isotopy in the complement of c), the second band move is performed on the innermost arc of the q arcs parallel to c , creating q new parallel arcs even closer to c . After the second \mathbb{Q} -band move is performed, the outer arc of the q new arcs and the inner arc of the q arcs coming from the first band move of type α form a band (see shaded area in Figure 2.4). Then, using isotopy in the complement of c , we eliminate this band by pulling it along c . This will result in the elimination of $p - q$ pairs of parallel arcs to c . In our example, this is done in Figure 2.5.

As in the case of integral surgery the twists coming from the two band moves com-

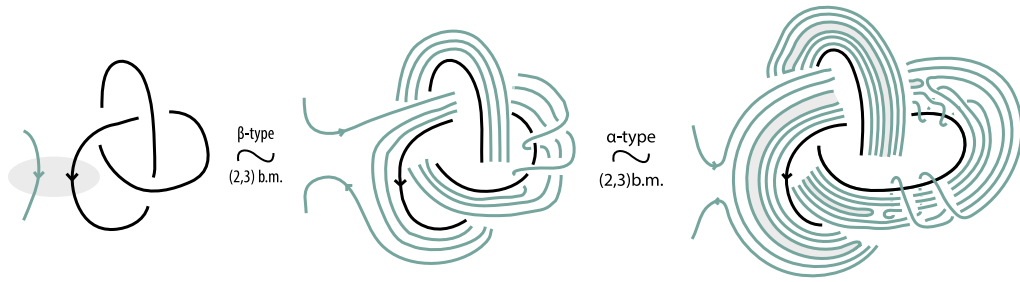

Fig. 2.4: A band move of type β followed by a band move of type α .

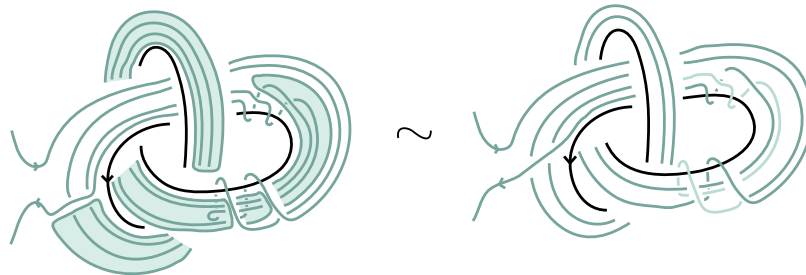

Fig. 2.5: Band with boundary two parallel arcs of opposite orientations.

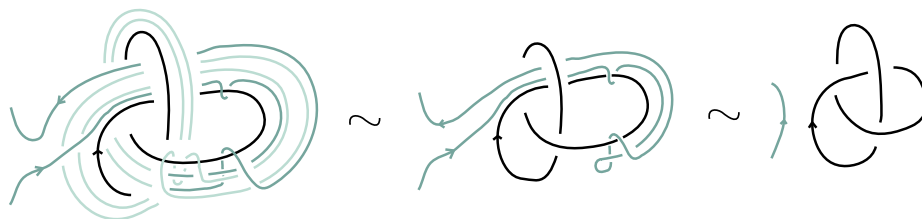

Fig. 2.6: Retracting the band along the surgery component.

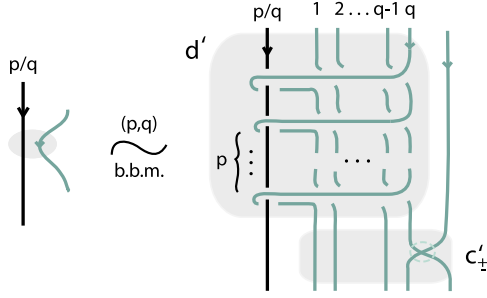

Fig. 2.7: A \mathbb{Q} -braid band move locally.

mute. Arranging these $2p$ twists pairwise, they cancel out by the fact that all twists have the same handedness, but opposite orientation. In the end, s is left as in its initial position.

So, a \mathbb{Q} -band move of type β can be performed using a \mathbb{Q} -band move of type α and isotopy in the complement of the surgery component c . The proof of Theorem 2.2 is now concluded. \square

2.3 Geometric \mathbb{Q} -mixed braid equivalence

In this section we extend Theorem 1.12 to manifolds with rational surgery description, that is $M = \chi_{\mathbb{Q}}(S^3, \widehat{B})$, using the sharpened Reidemeister theorem for M (Theorem 2.2). We first need the following.

Definition 2.1. A *geometric \mathbb{Q} -braid band move* is a move between geometric mixed braids which is a \mathbb{Q} -band move of type α between their closures. It starts with a little band (an arc of the moving subbraid) close to a surgery strand with surgery coefficient p/q . The little band gets first one twist *positive* or *negative*, which shall be denoted as c'_{\pm} and then is replaced by q strands that run in parallel to all strands of the same surgery component and link only with that surgery strand, wrapping around it p times and, thus, forming a (p, q) -torus knot. See Figure 2.7 for local and Figure 2.10 (shaded area) for global illustration. This braided (p, q) -torus knot is denoted as d' . A geometric \mathbb{Q} -braid band move with a positive (resp. negative) twist shall be called a positive geometric \mathbb{Q} -braid band move (resp. negative geometric \mathbb{Q} -braid band move).

By Remark 1(ii) a \mathbb{Q} -braid band move may be assumed to take place at the top part of a mixed braid and all strands from a \mathbb{Q} -braid band move may be assumed to lie on the righthand side of the surgery strands. We shall now prove the following.

Theorem 2.3 (Geometric braid equivalence for $M = \chi_{\mathbb{Q}}(S^3, \widehat{B})$). *Two oriented links in M are isotopic if and only if any two corresponding geometric mixed braids in S^3 differ by mixed braid isotopy, by L -moves that do not touch the fixed subbraid B and by the geometric \mathbb{Q} -braid band moves.*

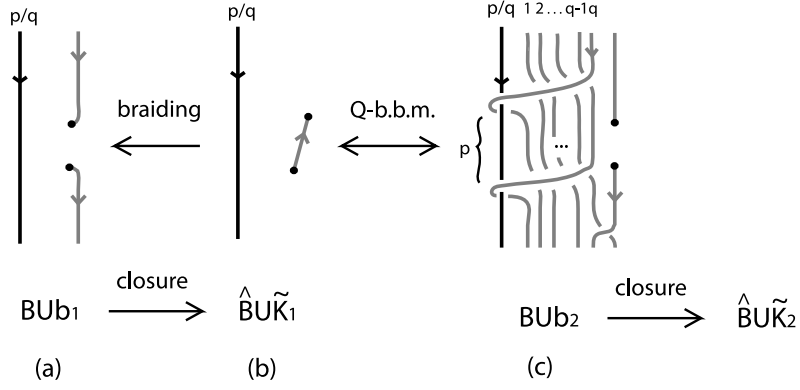

Fig. 2.8: A type α band move and its braiding (locally).

Proof. The proof is completely analogous to and is based on the proof of Theorem 5.10 [LR97] (Theorem 1.12). Let K_1 and K_2 be two isotopic oriented links in M . By Theorem 2.2, the corresponding mixed links $\widehat{B} \cup K_1$ and $\widehat{B} \cup K_2$ differ by isotopy in the complement of \widehat{B} and \mathbb{Q} -band moves of type α . Note that, by Theorem 2.2 we do not need to consider band moves of type β . By Theorem 5.10 [LR97], isotopy in the complement of \widehat{B} translates into geometric braid isotopy and the L -moves. Let now $\widehat{B} \cup K_1$ and $\widehat{B} \cup K_2$ differ by a \mathbb{Q} -band move of type α (recall Figure 2.1). Let $\widehat{B} \cup \widetilde{K}_1$ and $\widehat{B} \cup \widetilde{K}_2$ be two mixed link diagrams of the mixed links $\widehat{B} \cup K_1$ and $\widehat{B} \cup K_2$ which differ only by the places illustrated in Figure 2.8. As in [LR97], by the braiding algorithm given therein, the diagrams $\widehat{B} \cup \widetilde{K}_1$ and $\widehat{B} \cup \widetilde{K}_2$ may be assumed braided everywhere except for the places where the \mathbb{Q} -band move is performed.

We now braid the up-arc in Figure 2.8(b) and obtain a geometric mixed braid $\widehat{B} \cup b_1$ corresponding to the diagram $\widehat{B} \cup \widetilde{K}_1$ (see Figure 2.8(a)). Note that Figure 2.8(c) is already in braided form and let $B \cup b_2$ denote the geometric mixed braid corresponding to the diagram $\widehat{B} \cup \widetilde{K}_2$.

We would like to show that the two mixed braids $B \cup b_1$ and $B \cup b_2$ differ by the moves given in the statement of the Theorem.

We perform a Reidemeister I move on $\widehat{B} \cup \widetilde{K}_1$ with a *negative* crossing and obtain the diagram $\widehat{B} \cup \widetilde{K}'_1$. Then, the corresponding mixed braids, $B \cup b_1$ and $B \cup b'_1$, differ by mixed braid isotopy and L -moves (see Figure 2.9(a) and (b)). We then perform a *positive* \mathbb{Q} -braid band move on $B \cup b'_1$ and obtain the mixed braid $B \cup b'_2$. In the closure of $B \cup b'_2$ we unbraid and re-introduce the two up-arcs illustrated in Figure 2.9(b), obtaining a diagram $\widehat{B} \cup \widetilde{K}'_2$ with the formation of a Reidemeister II move. Performing this move on $\widehat{B} \cup \widetilde{K}'_2$ we obtain the diagram $\widehat{B} \cup \widetilde{K}_2$, which is already in braided form and its corresponding mixed braid is $B \cup b_2$ (see Figure 2.9(c) and (d)). So, the mixed braids $B \cup b'_2$ and $B \cup b_2$ differ by mixed braid isotopy and L -moves. Therefore, we showed that the braids $B \cup b_1$ and $B \cup b_2$ in Figure 2.8(a) and (c) differ by mixed braid isotopy, L -moves and a braid band move. This concludes the proof. \square

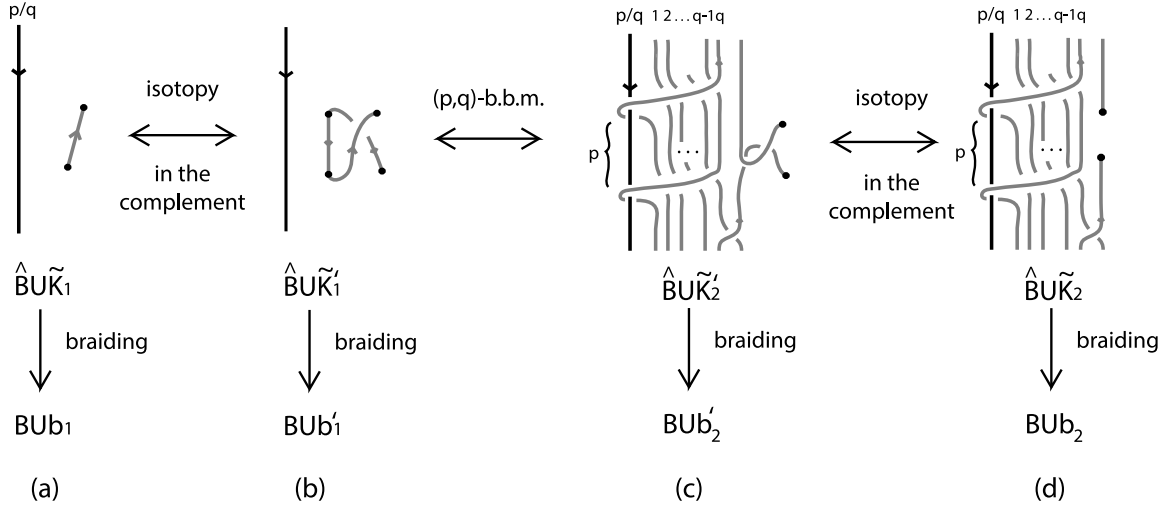

Fig. 2.9: The steps of the proof of Theorem 2.3.

2.3.1 Introducing cabling

In order to translate the geometric mixed braid equivalence to an equivalence of algebraic mixed braids we follow the strategy in [LR06]. Namely, we apply to the geometric mixed braids first parting and then combing. What makes things more complicated in the case of rational surgery description is that the surgery braid B is in general not a pure braid and when we apply a \mathbb{Q} -braid band move on a mixed braid, the little band that approaches the surgery strand is replaced by q strands that run in parallel to all strands of the same surgery component. In order to proceed we need the notion of a q -strand cable.

Definition 2.2. We define a q -strand cable to be a set of q parallel strands coming from a \mathbb{Q} -braid band move and following one strand of the specified surgery component.

Treating the new strands coming from the braid band move as cables running in parallel to the strands of a surgery component, that is, treating each cable as one thickened strand, we may adopt and apply results from [LR06].

2.4 Parted \mathbb{Q} -mixed braid equivalence

Let $B \cup \beta$ be a geometric mixed braid and suppose that a \mathbb{Q} -braid band move is performed on it. We part $B \cup \beta$ following the exact procedure as in [LR06]. More precisely, we have the following.

Lemma 2.1. *Cabling and standard parting commute. That is, standard parting of a mixed braid with a \mathbb{Q} -braid band move performed and then cabling, is the same as cabling first the set of new strands and then standard parting.*

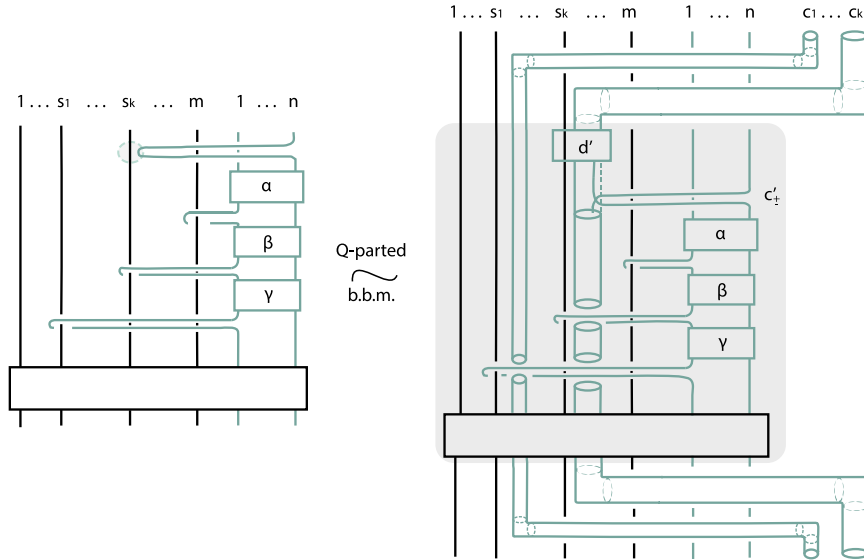

Fig. 2.10: A parted \mathbb{Q} -braid band move using cables.

Proof. Let $B \cup \beta$ be a geometric mixed braid on $m + n$ strands and let a \mathbb{Q} -braid band move be performed on a surgery component s of B . Let also $s_1, \dots, s_k \in \{1, \dots, m\}$ be the numbers of the strands of the surgery component s and let c_1, \dots, c_k denote the q -strand cables corresponding to s_1, \dots, s_k . On the one hand, after the \mathbb{Q} -braid band move is performed and before any cablings occur, we part the geometric mixed braid following the procedure of the standard parting as described in §1.6.3 (recall middle illustration of Figure 1.16). On the other hand we cable first each set of q -strands resulting from the \mathbb{Q} -braid band move and then we part the geometric mixed braid with the standard parting, treating each cable as one (thickened) strand. Since both cabling and parting a geometric mixed braid respect the position of the endpoints of each pair of corresponding moving strands, it follows that cabling and parting commutes. \square

Recall from §1.6.3 that a geometric L -move can be turned to a parted L -move. In order to give the analogue of Theorem 1.13 in the case of rational surgery we also need to introduce the following adaptation of a parted \mathbb{Z} -braid band move.

Definition 2.3. A *parted \mathbb{Q} -braid band move* is defined to be a geometric \mathbb{Q} -braid band move between parted mixed braids, such that it takes place at the top part of the braid and on the right of the rightmost strand, s_k , of the specific surgery component, s , consisting of the strands s_1, \dots, s_k . Moreover, the little band starts from the last strand of the moving subbraid and it moves over each moving strand and each component of the surgery braid, until it reaches the last strand of s , and then is followed by parting of the resulting mixed braid, as illustrated in Figure 2.10.

Then Theorem 2.3 restricts to the following.

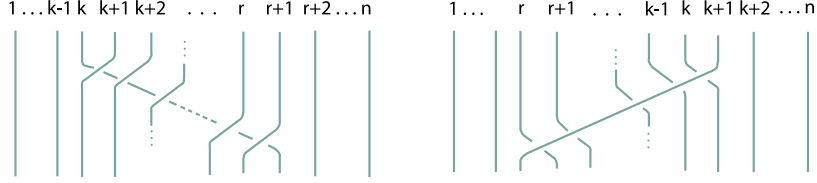

Fig. 2.11: The elements $\lambda_{k,r}$.

Theorem 2.4 (Parted version of braid equivalence for $M = \chi_{\mathbb{Q}}(S^3, \widehat{B})$). *Two oriented links in $M = \chi_{\mathbb{Q}}(S^3, \widehat{B})$ are isotopic if and only if any two corresponding parted mixed braids in $C_{m,\infty}$ differ by a finite sequence of parted L -moves, loop conjugations and parted \mathbb{Q} -braid band moves.*

Proof. By Lemma 2.1 the cables resulting from a geometric \mathbb{Q} -braid band move are treated as one strand, so we can apply Theorem 1.13. Moreover, by Lemma 9 in [LR06] a geometric \mathbb{Q} -braid band move may be always assumed, up to L -equivalence, to take place on the right of the rightmost strand of the specific surgery component. \square

2.5 Combing and cabling

In order to translate Theorem 2.4 into an algebraic equivalence between elements of $B_{m,\infty}$ we need the following lemmas.

Lemma 2.2 (Combing Lemma, Lemma 6 [LR06]). *The crossings Σ_k , $k = 1, \dots, m-1$ of the fixed subbraid B , and the loops a_i , for $i = 1, \dots, m$, satisfy the following ‘combing’ relations:*

$$\begin{aligned}
 \Sigma_k a_k^{\pm 1} &= a_{k+1}^{\pm 1} \Sigma_k \\
 \Sigma_k a_{k+1}^{\pm 1} &= a_{k+1}^{\pm 1} a_k^{\pm 1} a_{k+1} \Sigma_k \\
 \Sigma_k a_i^{\pm 1} &= a_i^{\pm 1} \Sigma_k & \text{if } i \neq k, k+1 \\
 \Sigma_k^{-1} a_k^{\pm 1} &= a_k a_{k+1}^{\pm 1} a_k^{-1} \Sigma_k^{-1} \\
 \Sigma_k^{-1} a_{k+1}^{\pm 1} &= a_k^{\pm 1} \Sigma_k^{-1} \\
 \Sigma_k^{-1} a_i^{\pm 1} &= a_i^{\pm 1} \Sigma_k^{-1} & \text{if } i \neq k, k+1.
 \end{aligned}$$

Notation: We set $\lambda_{k,r} := \sigma_k \sigma_{k+1} \dots \sigma_{r-1} \sigma_r$, for $k < r$ and $\lambda_{k,r} := \sigma_k \sigma_{k-1} \dots \sigma_{r+1} \sigma_r$, for $r < k$. We note that $\lambda_{i,i} := \sigma_i$. Also, by convention we set $\lambda_{0,i} = \lambda_{i,0} := 1$.

Then we have the following:

Lemma 2.3. *A positive looping between a q -strand cable and the j^{th} fixed strand of the fixed subbraid B has the algebraic expressions:*

$$\prod_{i=0}^{q-1} \lambda_{i,1} a_j \lambda_{i,1}^{-1} = \prod_{i=0}^{q-1} \lambda_{1,(q-1)-i}^{-1} a_j \lambda_{1,(q-1)-i} ,$$

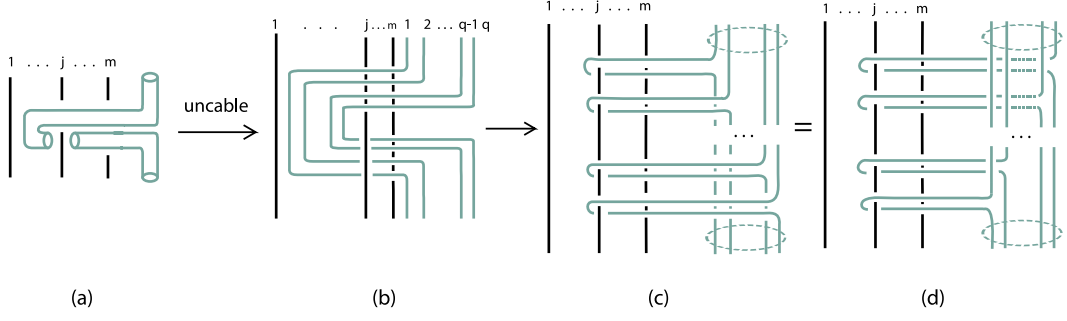

Fig. 2.12: A positive looping between a cable and a fixed strand.

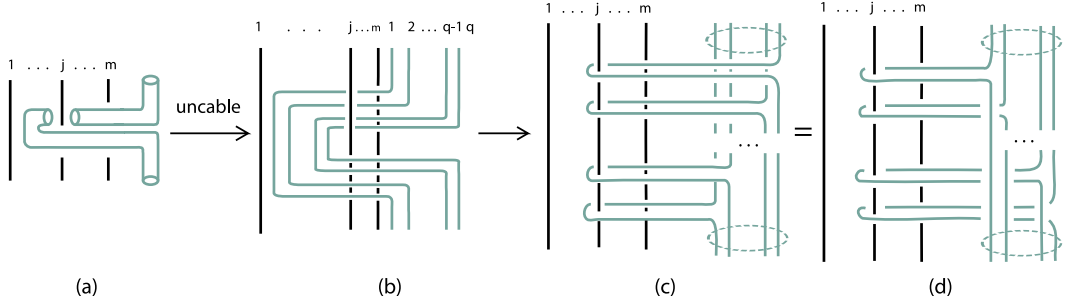

Fig. 2.13: A negative looping between a cable and a fixed strand.

while a negative looping has the algebraic expressions:

$$\prod_{i=0}^{q-1} \lambda_{1,i}^{-1} a_j^{-1} \lambda_{1,i} = \prod_{i=0}^{q-1} \lambda_{(q-1)-i,1} a_j^{-1} \lambda_{(q-1)-i,1}^{-1}.$$

Proof. We start with Figure 2.12(a) where a positive looping between a q -strand cable and a fixed stand of the mixed braid is shown. In Figure 2.12(b) the cable is replaced by the q strands according to Definition 2.2. Then, using mixed braid isotopy, we end up with Figure 2.12(c), top, whereby we can read directly the algebraic expression $\prod_{i=0}^{q-1} \lambda_{1,i}^{-1} a_j^{-1} \lambda_{1,i}$. The second algebraic expression comes from the bottom illustration of Figure 2.12. Similarly, in Figure 2.13 we illustrate the case where a negative looping between a q -strand cable and a fixed strand of the mixed braid occurs. \square

Lemma 2.4. *Cabling and combing commute. That is, treating a q -strand cable as a thickened moving strand and combing it through the fixed subbraid B , the result is equivalent to combing one by one each strand of the cable.*

Proof. According to the Combing Lemma we have to consider all cases between looping and crossings of the subbraid B . We will only examine the four cases illustrated in Figure 1.17 as representative cases. All others are completely analogous. The first case is illustrated in Figure 2.14, where a positive looping between the cable and the k^{th}

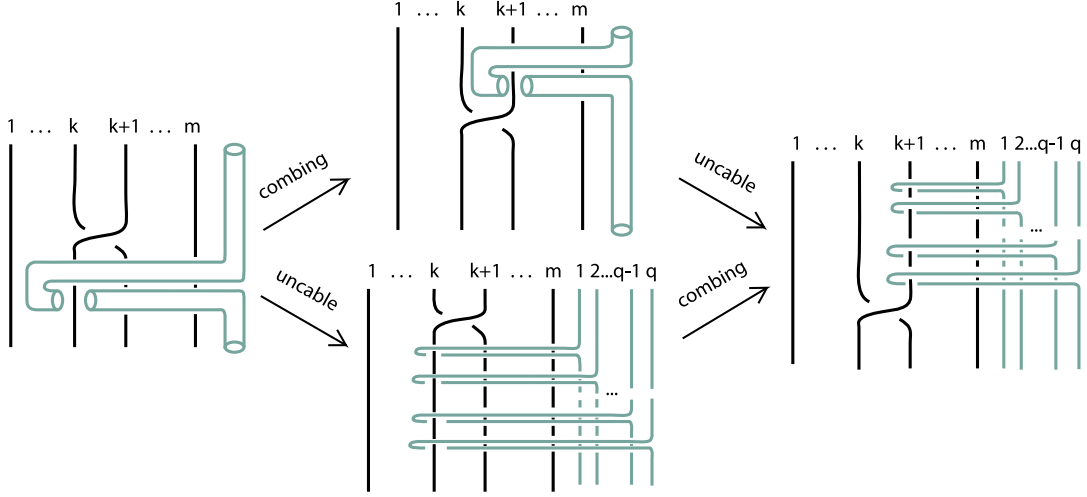

Fig. 2.14: Combing and cabling commute: Proof of Case 1.

fixed strand of B is being considered and the crossing of the fixed strands is positive. For a negative looping the proof is similar.

We now consider the case illustrated in Figure 2.15, where a positive looping between the cable and the $(k + 1)^{th}$ fixed strand of B is being considered, and the crossing in B is positive. We shall prove this case by induction on the number of strands that belong to the cable, since, as we can see from Figure 2.15, the resulting algebraic expressions are not directly comparable.

The case where the cable consists of one strand is trivial. For a two-strand cable, combing the cable first and then uncabling (see top part part of Figure 2.15) results in the algebraic expression:

$$\alpha_2^{-1} (\sigma_1^{-1} \alpha_2^{-1} \sigma_1) \alpha_1 (\sigma_1^{-1} \alpha_1 \sigma_1) \alpha_2 (\sigma_1^{-1} \alpha_2 \sigma_1),$$

while uncabling first and then combing (bottom part of Figure 2.15) results in the algebraic expression:

$$(\alpha_2^{-1} \alpha_1 \alpha_2) (\sigma_1^{-1} \alpha_2^{-1} \alpha_1 \alpha_2 \sigma_1).$$

We show below that these algebraic expressions are equal, whereby we have underlined expressions which are crucial for the next step. Indeed:

$$\begin{aligned}
\underline{\alpha_2^{-1}} (\sigma_1^{-1} \alpha_2^{-1} \sigma_1) \alpha_1 (\sigma_1^{-1} \alpha_1 \sigma_1^{-1}) \alpha_2 (\sigma_1 \alpha_2 \sigma_1^{-1}) &= \underline{(\alpha_2^{-1} \alpha_1 \alpha_2)} (\sigma_1 \alpha_2^{-1} \alpha_1 \alpha_2 \sigma_1^{-1}) \Leftrightarrow \\
(\sigma_1^{-1} \alpha_2^{-1} \sigma_1) \alpha_1 (\sigma_1^{-1} \alpha_1 \sigma_1^{-1}) \alpha_2 (\sigma_1) &= \underline{(\alpha_1 \alpha_2)} (\sigma_1 \alpha_2^{-1} \alpha_1) \Leftrightarrow \\
\sigma_1^{-1} \alpha_2^{-1} \sigma_1 \alpha_1 \alpha_2 \sigma_1 \alpha_1 \sigma_1^{-1} \sigma_1 &= \alpha_1 \alpha_2 \sigma_1 \alpha_2^{-1} \underline{\alpha_1} \Leftrightarrow \\
\sigma_1^{-1} \alpha_2^{-1} \sigma_1 \alpha_1 (\sigma_1^{-1} \sigma_1) \alpha_2 \sigma_1 &= \alpha_1 \alpha_2 \sigma_1 \alpha_2^{-1} \Leftrightarrow \\
\underline{\sigma_1^{-1} \sigma_1 \alpha_1 \sigma_1^{-1} \alpha_2^{-1} \sigma_1 \alpha_2 \sigma_1} &= \underline{\alpha_1 \alpha_2 \sigma_1 \alpha_2^{-1}} \Leftrightarrow \\
\sigma_1^{-1} \alpha_2^{-1} \sigma_1 \alpha_2 \sigma_1 &= \underline{\alpha_2 \sigma_1 \alpha_2^{-1}} \Leftrightarrow \\
\sigma_1 \alpha_2 \sigma_1 \alpha_2 &= \alpha_2 \sigma_1 \alpha_2 \sigma_1
\end{aligned}$$

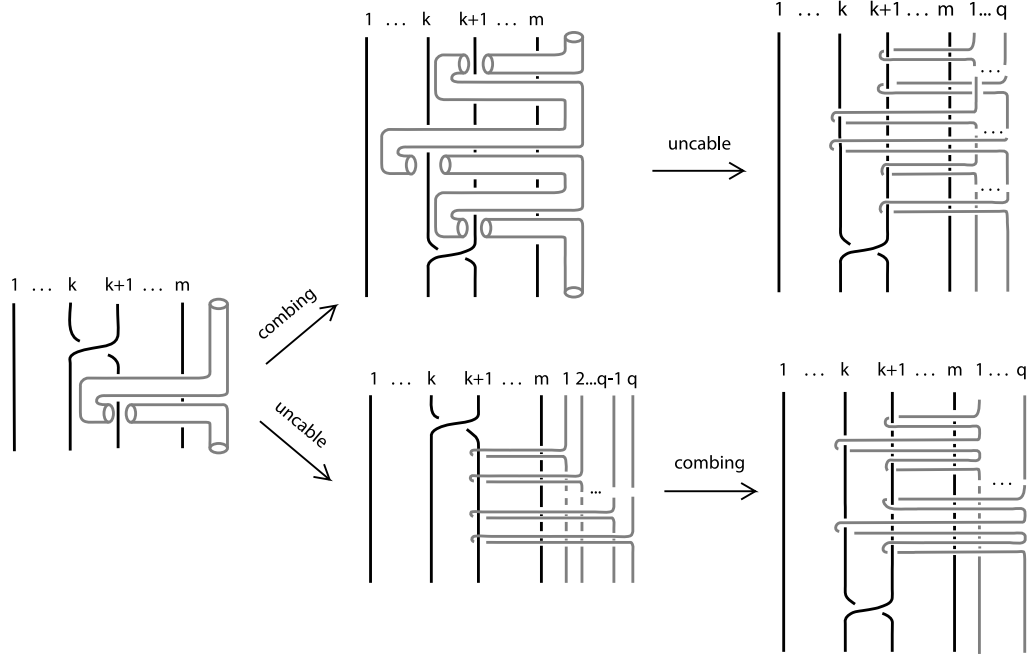

Fig. 2.15: Combing and cabling commute: Case 2.

We ended up with one of the defining relations of the mixed braid group $B_{m,n}$, recall (1.3).

We now consider a $(q+1)$ -strand cable and we let the first q strands form a q -strand subcable. We first comb the q -strand cable and then the $(q+1)^{st}$ strand and the result follows by applying the case of a 2-strand cable and the induction hypothesis for the q -strand cable (see Figure 2.16). \square

2.6 Algebraic \mathbb{Q} -mixed braid equivalence

Let now $B \cup \beta$ be a parted mixed braid and let a parted \mathbb{Q} -braid band move be performed on the last strand, s_k , of a surgery component consisting of the strands s_1, \dots, s_k . Recall Figure 2.10. In order to give an algebraic expression for the parted \mathbb{Q} -braid band move, we part locally the subbraids d' and c'_\pm and the loop generators a_i , $i = 1, \dots, m$, and we use mixed braid isotopy in order to transform d' into d and c'_\pm into c_\pm . See Figures 2.17, 2.18, 2.19. Then, d has the algebraic expression:

$$d = [\lambda_{n+kq-1, n+(k-1)q+1} \lambda_{n+1, n+(k-1)q}^{-1} \lambda_{n,1} a_{s_k} \lambda_{n,1}^{-1} \lambda_{n+1, n+(k-1)q}^{-1}]^p \quad (2.1)$$

and c_\pm has the algebraic expression:

$$c_\pm = \lambda_{n, n+kq-2} \sigma_{n+kq-1}^{\pm 1} \lambda_{n, n+kq-2}^{-1}. \quad (2.2)$$

We are now in the position to give the definition of an algebraic \mathbb{Q} -braid band move.

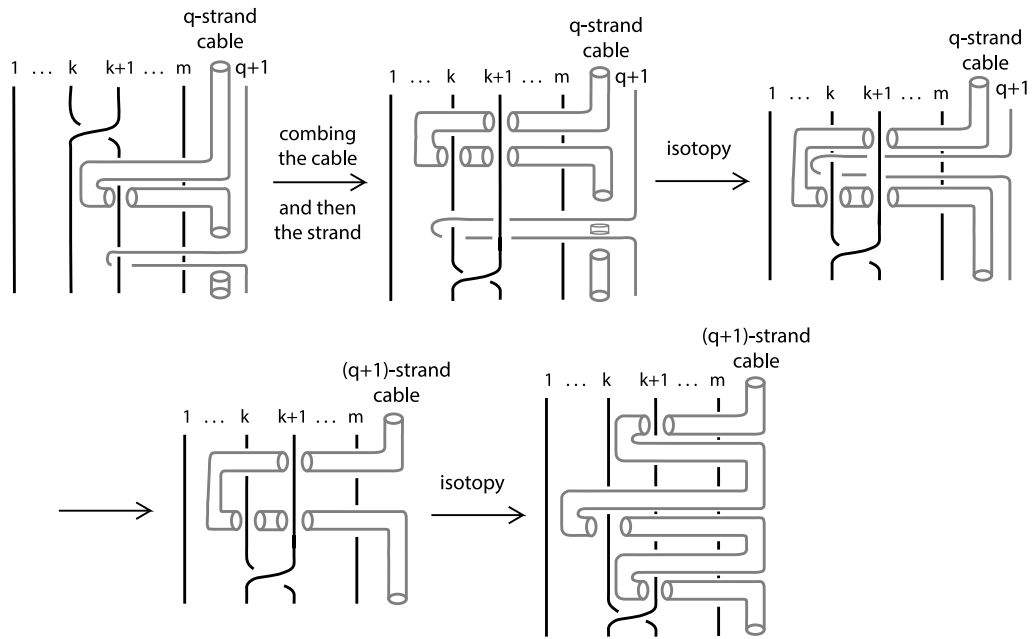

Fig. 2.16: Combing and cabling commute: Proof of Case 2.

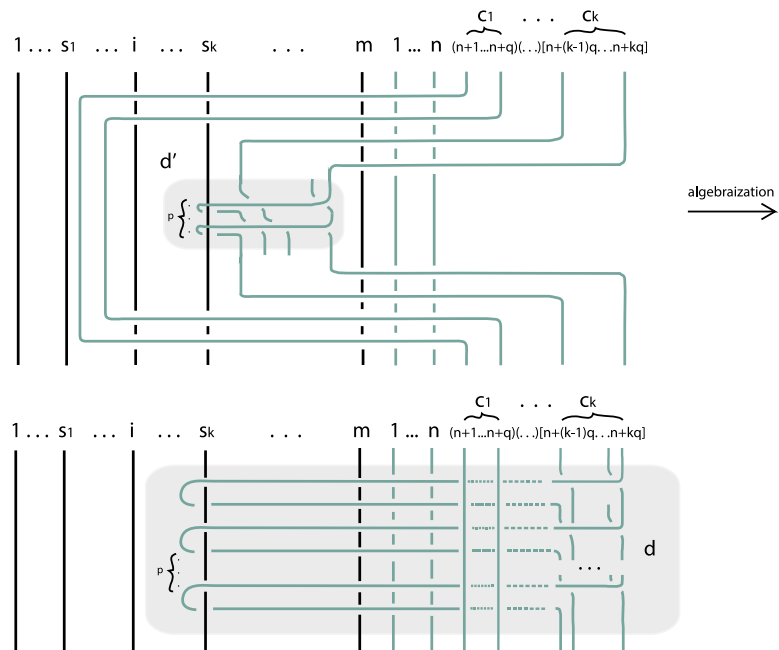

Fig. 2.17: Algebraization of the (p, q) -torus braid d' to d after a \mathbb{Q} -braid band move is performed.

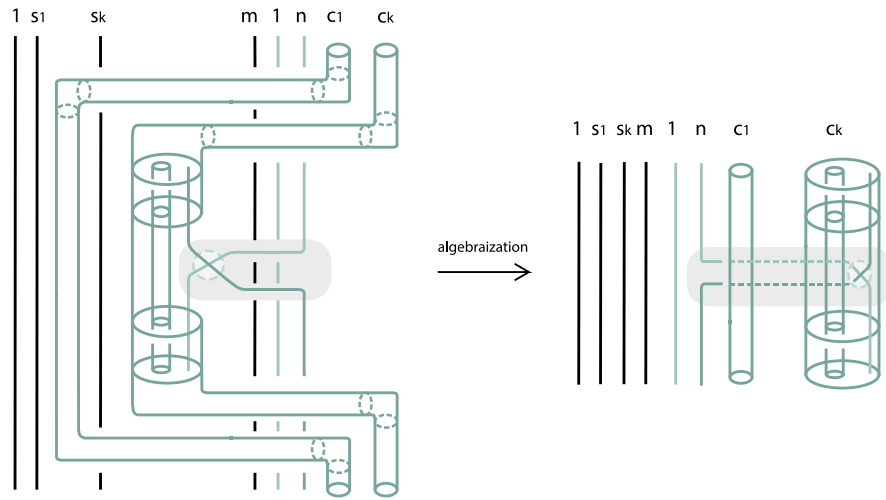

Fig. 2.18: Algebraization of the crossing part c'_\pm to c_\pm after a \mathbb{Q} -braid band move is performed.

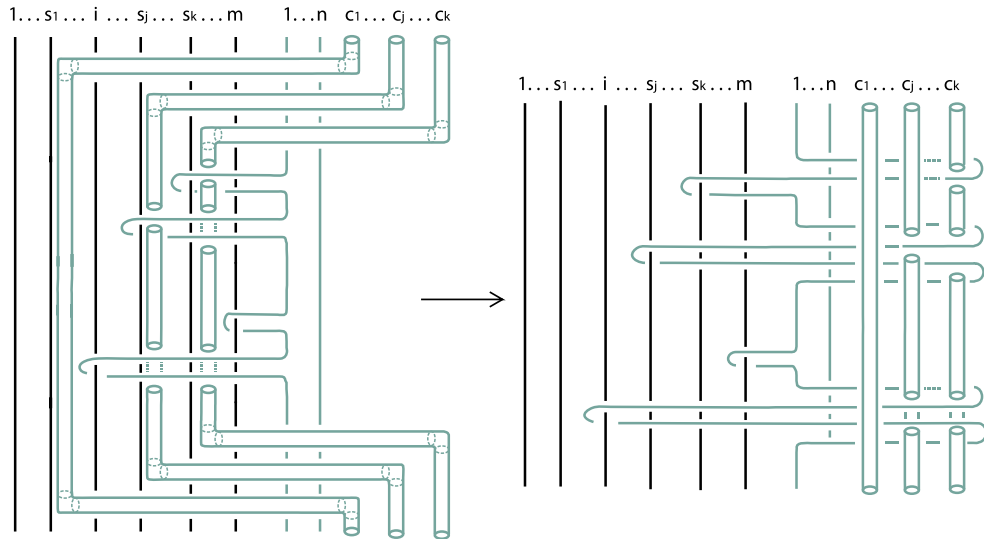

Fig. 2.19: Algebraization of the loop generators a_j after a \mathbb{Q} -braid band move is performed.

Definition 2.4. (i) An *algebraic \mathbb{Q} -braid band move* is defined to be a parted \mathbb{Q} -braid band move between elements of $B_{n,\infty}$ and it has the following algebraic expression:

$$\beta \sim d c_{\pm} \beta',$$

where β' is the algebraic mixed braid β with the substitutions:

$$a_i^{\pm 1} \longleftrightarrow a_i^{\pm 1}, \quad \text{for } i > s_k,$$

$$a_i^{\pm 1} \longleftrightarrow \begin{array}{l} \lambda_{n-1,1}^{-1} \lambda_{n,n+kq-1} \lambda_{n+kq-1,1} a_i^{\pm 1} \\ \lambda_{n-1,1}^{-1} \lambda_{n+kq-1,n}^{-1} \lambda_{n,n+kq-1}^{-1} \lambda_{n-1,1}, \quad \text{for } i < s_1, \end{array}$$

$$a_{s_j} \longleftrightarrow \lambda_{n-1,1}^{-1} \lambda_{n,n+kq-1} \lambda_{n+kq-1,n+(j-1)q} \lambda_{n,n+(j-1)q-1}^{-1} \lambda_{n-1,1} a_{s_j}$$

$$a_{s_j}^{-1} \longleftrightarrow \begin{array}{l} \lambda_{n-1,1}^{-1} \lambda_{n,n+jq-1} \lambda_{n+kq-1,n+jq} \lambda_{n,n+kq-1}^{-1} \lambda_{n-1,1} \\ \lambda_{n-1,1}^{-1} \lambda_{n,n+kq-1} \lambda_{n+kq-1,n+jq} \lambda_{n,n+jq-1}^{-1} \lambda_{n-1,1} a_{s_j}^{-1} \\ \lambda_{n-1,1}^{-1} \lambda_{n,n+(j-1)q-1} \lambda_{n+kq-1,n+(j-1)q}^{-1} \lambda_{n+kq-1,n}^{-1} \lambda_{n-1,1}, \\ \text{for } s_j \in \{s_1, \dots, s_k\}, \end{array}$$

$$a_j^{\pm 1} \longleftrightarrow \begin{array}{l} \lambda_{n-1,1}^{-1} \lambda_{n,n+kq-1} \lambda_{n+kq-1,n+(r-1)q} \lambda_{n,n+(r-1)q-1}^{-1} \lambda_{n-1,1} a_j^{\pm 1} \\ \lambda_{n-1,1}^{-1} \lambda_{n,n+(r-1)q-1} \lambda_{n+kq-1,n+(r-1)q}^{-1} \lambda_{n,n+kq-1}^{-1} \lambda_{n-1,1}, \quad \text{for } s_{r-1} < j < s_r. \end{array}$$

(ii) A *combed algebraic \mathbb{Q} -braid band move* is a move between algebraic mixed braids and is defined to be a parted \mathbb{Q} -braid band move that has been combed through B . Moreover, it has the following algebraic expression:

$$\beta \sim d c_{\pm} \beta' \text{ comb}_B(c_1, \dots, c_k),$$

where $\text{comb}_B(c_1, \dots, c_k)$ is the combing of the parted q -strand cables c_1, \dots, c_k through the surgery braid B (see Figure 2.20).

We are, finally, in the position to state the following main result of the paper.

Theorem 2.5 (Algebraic mixed braid equivalence for $M = \chi_{\mathbb{Q}}(S^3, \widehat{B})$). *Let s_1, \dots, s_k be the numbers of the strands of a surgery component s and let c_1, \dots, c_k be the corresponding q -strand cables arising from a \mathbb{Q} -braid band move performed on s . Then, two oriented links in M are isotopic if and only if any two corresponding algebraic mixed braid representatives in $B_{m,\infty}$ differ by a finite sequence of the following moves:*

(i) *M -moves: $\beta_1 \beta_2 \sim \beta_1 \sigma_n^{\pm 1} \beta_2$, for $\beta_1, \beta_2 \in B_{m,n}$,*

(ii) *M -conjugation: $\beta \sim \sigma_j^{\mp 1} \beta \sigma_j^{\pm 1}$, for $\beta, \sigma_j \in B_{m,n}$,*

(iii) *Combed loop conjugation: $\beta \sim \alpha_i^{\mp 1} \beta \rho_i^{\pm 1}$, for $\beta \in B_{m,n}$, where ρ_i is the combing of the loop α_i through B ,*

(iv) *Combed algebraic braid band moves: $\beta \sim d c_{\pm} \beta' \text{ comb}_B(c_1, \dots, c_k)$, where the algebraic expressions of d and c_{\pm} are as in Eqs. (3) and (4) respectively, β' is β with the substitutions of the loop generators as in Definition 2.4 and $\text{comb}_B(c_1, \dots, c_k)$ is the*

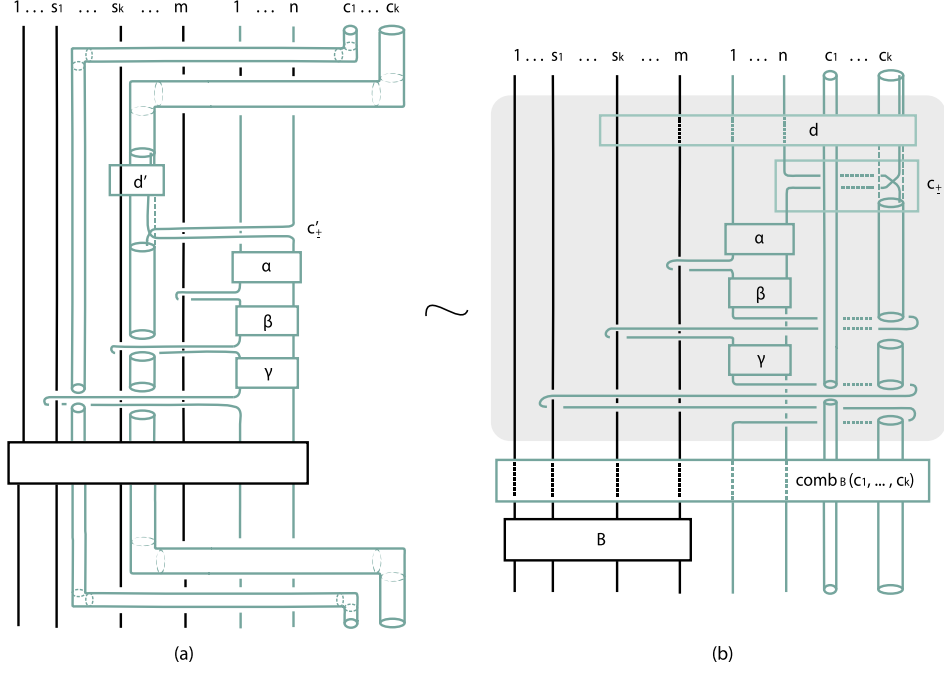

Fig. 2.20: Combing a parted \mathbb{Q} -braid band move results in an algebraic \mathbb{Q} -braid band move followed by its combing.

combing of the resulting q -strand cables c_1, \dots, c_k through the fixed subbraid B . Equivalently, by the same moves as above, where (i) and (ii) are replaced by algebraic L -moves (see algebraic expressions in Eqs. 2).

Proof. The arguments for passing from parted braid equivalence (Theorem 2.4) to algebraic braid equivalence are the same as in those in the proof of the transition from Theorem 1.13 to Theorem 1.14 in the case of integral surgery. The only part we need to analyze in detail is the algebraization of a parted \mathbb{Q} -braid band move. Namely, we will show that the following diagram commutes.

$$\begin{array}{ccc}
 C_{m,n} \ni B \cup \beta & \xrightarrow{\text{Parted } \mathbb{Q}\text{-b.b.m.}} & B \cup \beta' \in C_{m,n+kq} \\
 \parallel & & \parallel \\
 \text{comb}_B(\beta) & & \text{comb}_B(\beta') \\
 \downarrow & & \downarrow \\
 B_{m,n} \ni \text{alg}_B(\beta) & \xrightarrow{\text{Algebraic } \mathbb{Q}\text{-b.b.m.}} & \text{alg}_B(\beta') \in B_{m+n+kq}
 \end{array}$$

In words, we start with a parted mixed braid $B \cup \beta \in C_{m,n}$ and we perform on it a parted \mathbb{Q} -braid band move (Definition 2.3) obtaining a parted mixed braid $B \cup \beta' \in C_{m,n+kq}$, where k is the number of strands forming the surgery component. We then comb both parted mixed braids obtaining $\text{comb}_B(\beta)$ and $\text{comb}_B(\beta')$ respectively. We will show that the corresponding algebraic parts, $\text{alg}_B(\beta) \in B_{m,n}$ and $\text{alg}_B(\beta') \in B_{m,n+kq}$ differ by the

algebraic braid equivalence given in the statement of the theorem. We apply Lemma 8 in [LR06], where the q strands of a braid band move are placed in the cable and the cable is treated as one strand. More precisely, we note that the parted \mathbb{Q} -braid band move takes place at the top of the braid, so it forms an algebraic \mathbb{Q} -braid band move. We now comb away β to the top of B and on the other side we comb away β' . Since the q -strands cable of the parted \mathbb{Q} -braid band move lie very close to the surgery strands, this ensures that the loops $\alpha_j^{\pm 1}$ around any strand of the k strands of the specific surgery components get combed in the same way before and after the \mathbb{Q} -braid band move. So, having combed away β we are left at the bottom with the identity moving braid on the one hand, and with the combing of all cables of the braid band move on the other hand, which is precisely what we denote $comb_B()$. Finally, by Lemma 2.4, combing and cabling commute. Thus, the Theorem is proved. \square

2.7 Applications

In this section we give the braid equivalences for knots in specific families of 3-manifolds that play a very important role in 3-dimensional topology, such as the lens spaces $L(p, q)$, homology spheres and Seifert manifolds. It is worth mentioning, in general, that any framed link gives rise to a whole family of 3-manifolds obtained from different rational surgeries along the link. This approach sets the ground for a homogeneous treatment for studying the knot theory of 3-manifolds, for example the skein modules of oriented 3-manifolds with or without boundary.

2.7.1 Illustrations for an abstract generic example

Let M be the manifold obtained by rational surgery along a framed link \widehat{B} in S^3 . Let also $B \cup \beta$ be a parted mixed braid representing a link in M . In Figures 2.21 to 2.26 we illustrate step-by-step the algebraization of a geometric \mathbb{Q} -braid band move. More precisely, in Figure 2.21 a geometric \mathbb{Q} -braid band move takes place on the last strand of a surgery component (s_1, \dots, s_k) of B . In Figure 2.22 we part all cables c_1, \dots, c_k arising from the geometric \mathbb{Q} -braid band move, turning the initial geometric \mathbb{Q} -braid band move to a parted \mathbb{Q} -braid band move. In Figure 2.22 we also part locally the (p, q) -torus subbraid d' . This leads to the algebraic expression d of d' , illustrated in Figure 2.23, where the local parting of the crossing subbraid c'_\pm is also initiated. In Figure 2.24 the algebraic expression c_\pm of c'_\pm is illustrated and the local parting of all loop generators is also initiated. This leads to the algebraic expressions of the loop generators, in Figure 2.25, where also the preparation for combing of the cables c_1, \dots, c_k through B is illustrated. Note that the top part of Figure 2.25 (above the dotted line) illustrates an algebraic \mathbb{Q} -braid band move. Finally, in Figure 2.26 the combing of the cables c_1, \dots, c_k through B is performed and the final result is a combed algebraic \mathbb{Q} -braid band move.

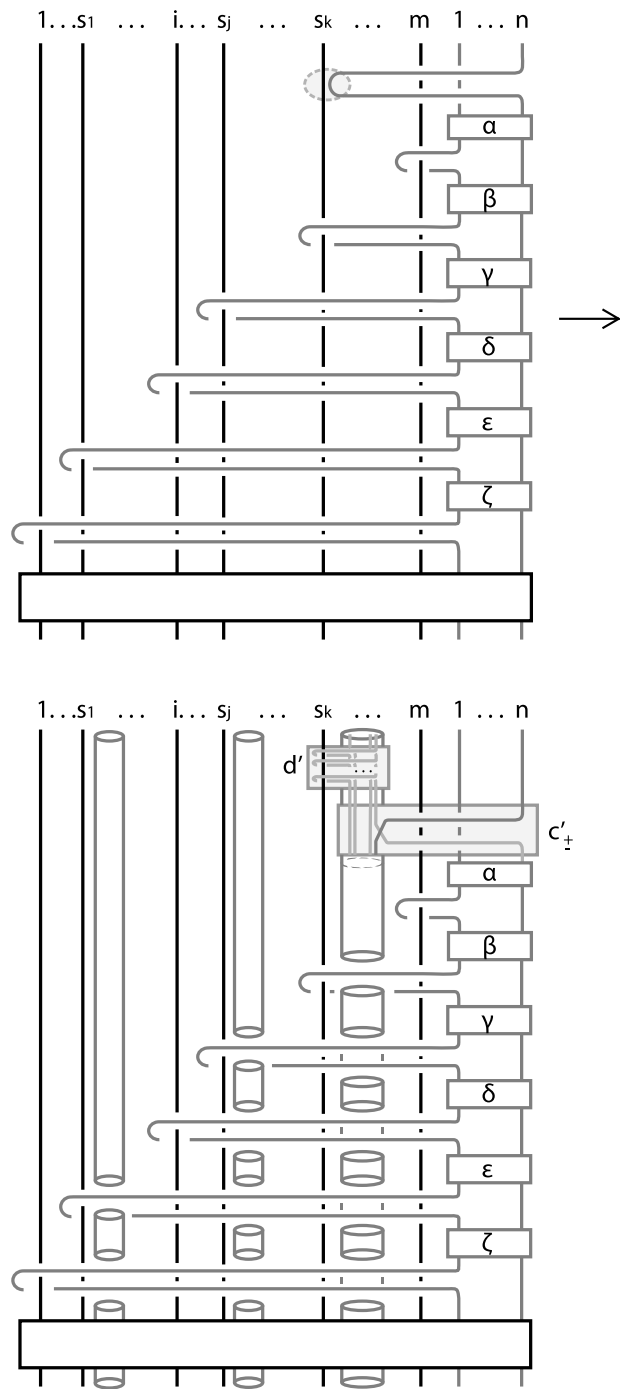

Fig. 2.21: A geometric \mathbb{Q} -braid band move.

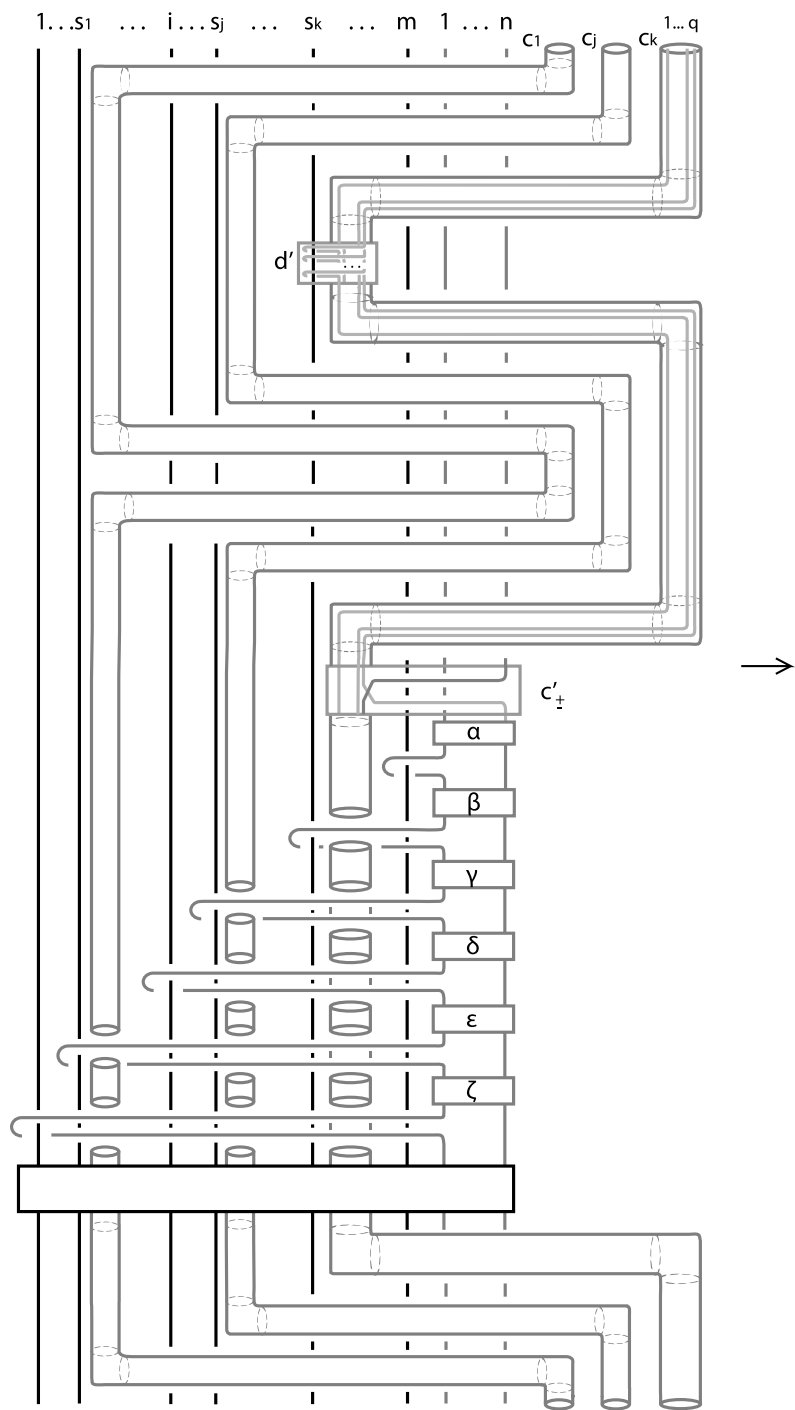

Fig. 2.22: Parting locally d' .

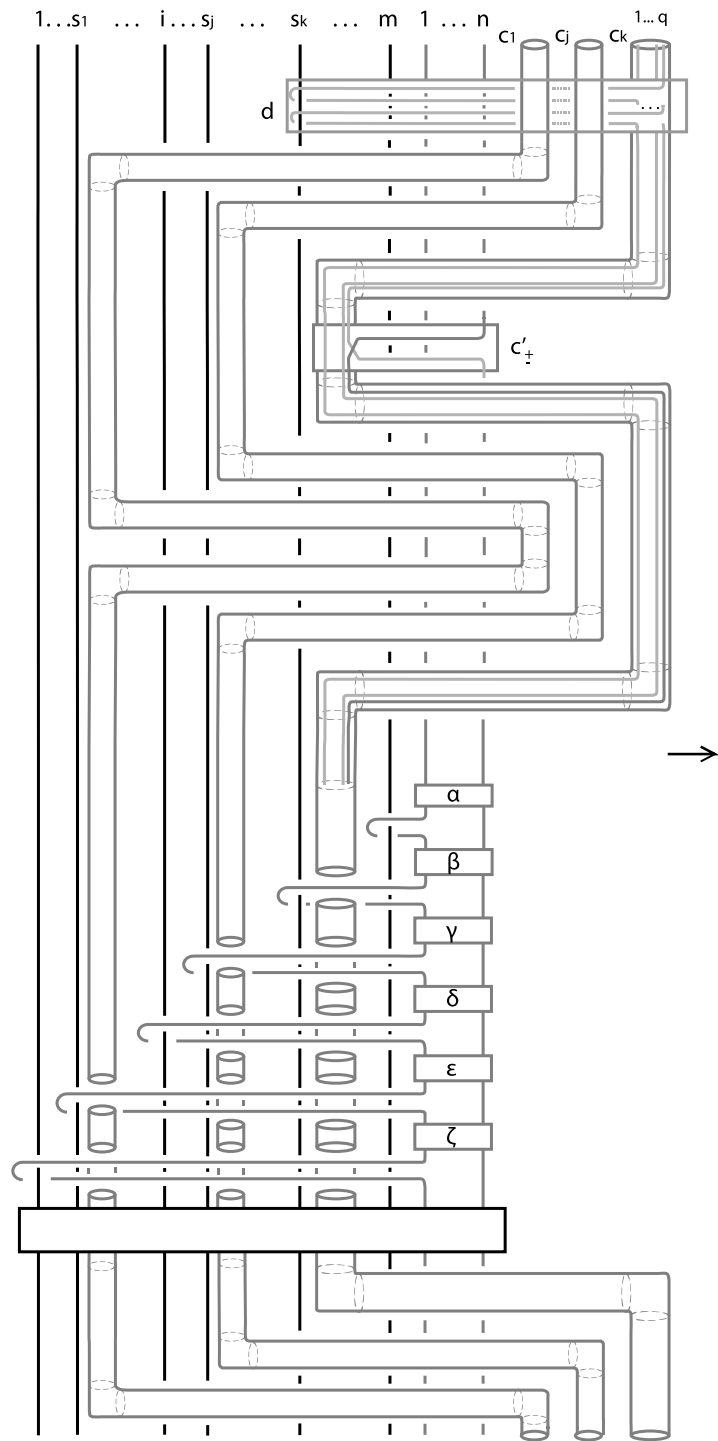

Fig. 2.23: Algebraization of d' to d and local parting of c'_{\pm} .

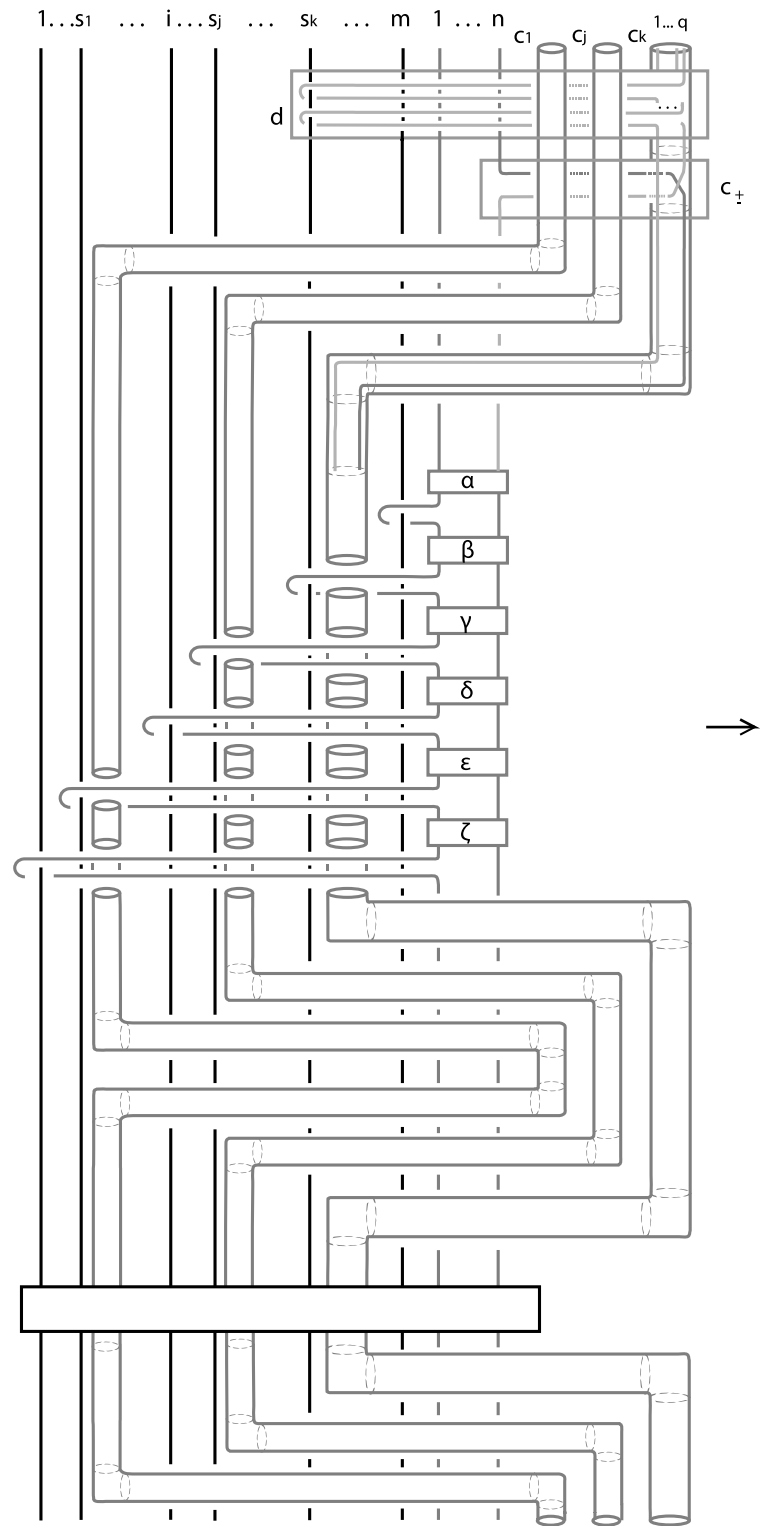

Fig. 2.24: Algebraization of c'_\pm to c and local parting of the loop generators a_i .

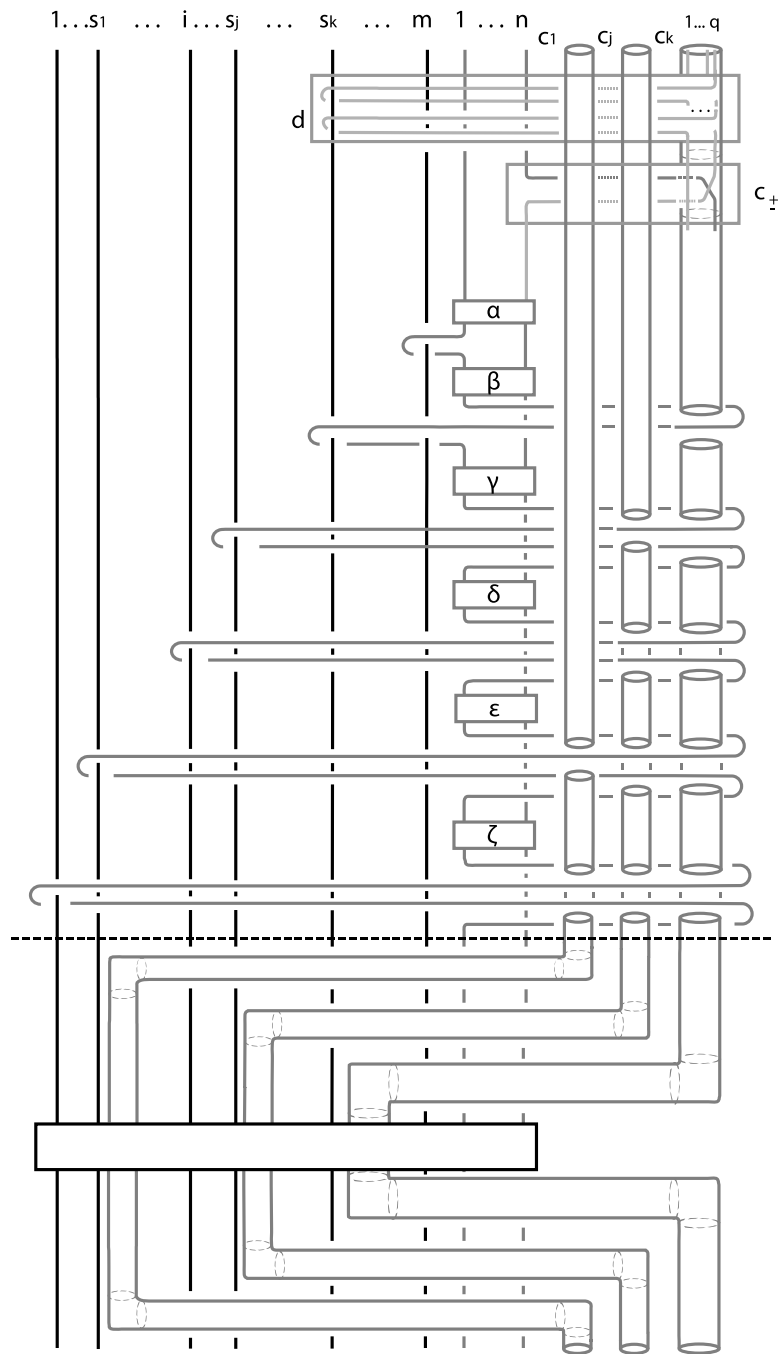

Fig. 2.25: Algebraization of the loop generators and preparation for combing.

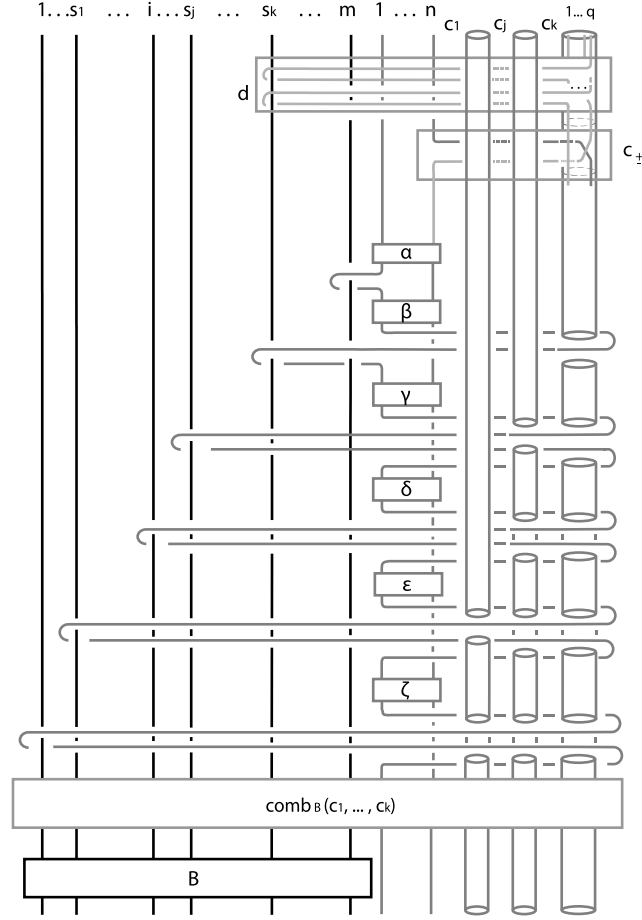

Fig. 2.26: The combing of the cables through B .

2.7.2 Lens spaces $L(p, q)$

It is known that the lens spaces $L(p, q)$ can be obtained by surgery on the unknot with surgery coefficient p/q . So, the fixed braid \hat{B} that represents $L(p, q)$ is the identity braid of one single strand and thus, no combing is needed. We have the following (compare with [LR06, §4]):

Two oriented links in $L(p, q)$ are isotopic if and only if any two corresponding algebraic mixed braids in $B_{1, \infty}$ differ by a finite sequence of the moves given in Theorem 2.5, where in particular:

(iv) *Algebraic braid band moves: For $\beta \in B_{1, n}$ we have: $\beta \sim d c_{\pm} \beta'$, where:*

$$d = [\lambda_{n+q-1, 1} a_1 \lambda_{1, n+q-1}^{-1}]^p, \quad c_{\pm} = \lambda_{n, n+q-1} \sigma_{n+q-1}^{\pm 1} \lambda_{n, n+q-1}^{-1},$$

and where $\beta' \in B_{1, n+q}$ is the word β with the substitutions:

$$a_1 \longleftrightarrow (\lambda_{n-1, 1}^{-1} \lambda_{n, n+q-1} \lambda_{n+q-1, 1}) a_1, \quad \text{and} \quad a_1^{-1} \longleftrightarrow a_1^{-1} (\lambda_{n+q-1, 1}^{-1} \lambda_{n, n+q-1}^{-1} \lambda_{n-1, 1}).$$

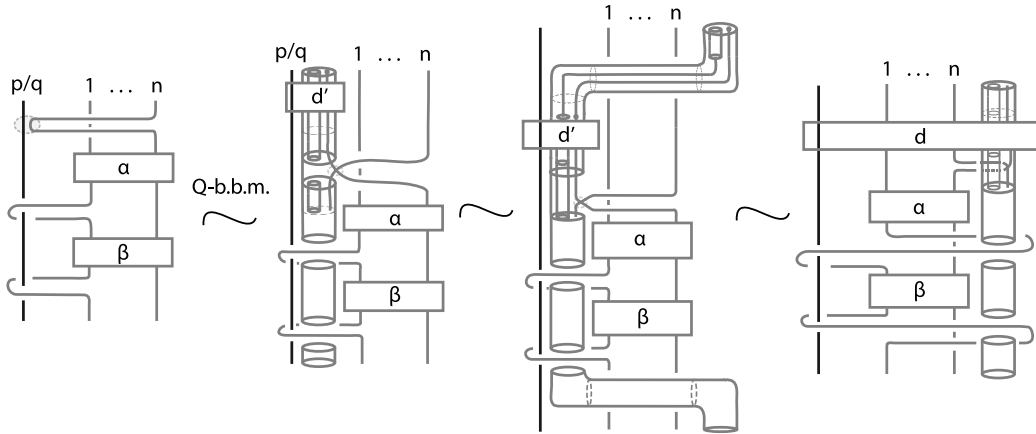

Fig. 2.27: A \mathbb{Q} -braid band move in $L(p, q)$ and its algebraization.

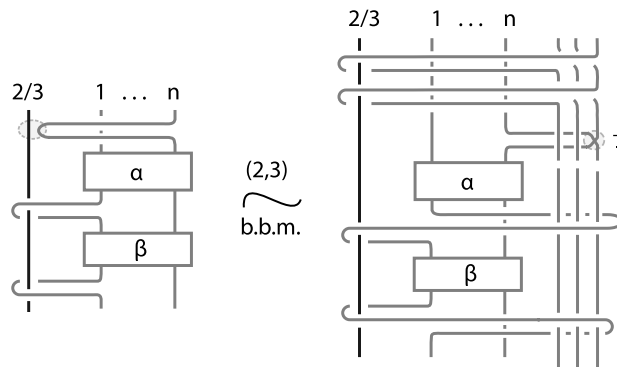

Fig. 2.28: An algebraic \mathbb{Q} -braid band move in $L(2, 3)$.

In Figure 2.28 the case where $p = 2$ and $q = 3$ is illustrated.

2.7.3 Homology spheres

It is known that a Dehn surgery on a knot yields a homology sphere exactly when the surgery coefficient is the reciprocal of an integer (see [Rol76] p.262). For example, surgery on the right-handed trefoil, with surgery coefficient -1 yields the Poincare Manifold also known as dodecahedral space (for the algebraic braid equivalence in this case see [LR06, §4]). In this subsection we give the algebraic braid equivalence for knots in a homology sphere M obtained from S^3 by surgery on the trefoil knot with rational surgery coefficient $1/q$, where $q \in \mathbb{Z}$. As explained in [Rol84] if one used integral surgery description, one would need a different knot for each q .

Two oriented links in M are isotopic if and only if any two corresponding algebraic mixed braids in $B_{2,\infty}$ differ by a finite sequence of the moves given in Theorem 2.5, where in particular:

(iv) Combed algebraic braid band moves: $\beta \sim d c_{\pm} \beta' \text{ comb}_B(c_1, c_2)$, where:

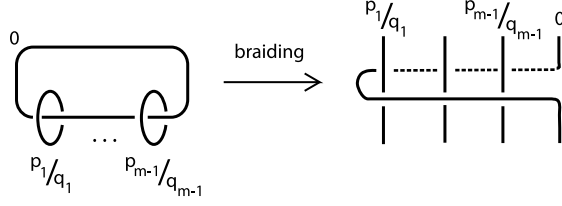

Fig. 2.29: Surgery description of a Seifert manifold.

$\beta \in B_{2,n}$,

$$d = (\lambda_{n+2q-1,n+q+1} \lambda_{n+1,n+q}^{-1} \lambda_{n,1}) a_2 (\lambda_{n,1}^{-1} \lambda_{n+1,n+q}),$$

$$c_{\pm} = \lambda_{n,n+2q-1} \sigma_{n+2q-1}^{\pm 1} \lambda_{n,n+2q-1}^{-1},$$

β' is the word β with the substitutions:

$$a_1 \longleftrightarrow (\lambda_{n-1,1}^{-1} \lambda_{n,n+2q-1} \lambda_{n+2q-1,n+q} \lambda_{n,n+q-1}^{-1} \lambda_{n-1,1}) a_1,$$

$$a_1^{-1} \longleftrightarrow a_1^{-1} (\lambda_{n-1,1}^{-1} \lambda_{n,n+q-1} \lambda_{n+2q-1,n+q}^{-1} \lambda_{n,n+2q-1}^{-1} \lambda_{n-1,1}),$$

$$a_2 \longleftrightarrow \begin{aligned} & (\lambda_{n-1,1}^{-1} \lambda_{n,n+2q-1} \lambda_{n+2q-1,1}) a_2 \\ & (\lambda_{n-1,1}^{-1} \lambda_{n,n+q-1} \lambda_{n+2q-1,n+q}^{-1} \lambda_{n,n+2q-1}^{-1} \lambda_{n-1,1}), \end{aligned}$$

$$a_2^{-1} \longleftrightarrow \begin{aligned} & (\lambda_{n-1,1}^{-1} \lambda_{n,n+2q-1} \lambda_{n+2q-1,n+q} \lambda_{n,n+q-1}^{-1} \lambda_{n-1,1}) a_2^{-1} \\ & (\lambda_{n+2q-1,1}^{-1} \lambda_{n,n+2q-1}^{-1} \lambda_{n-1,1}), \end{aligned}$$

and $\text{comb}_B(c_1, c_2)$ is the combing of the q -strand cables (c_1 and c_2) through the fixed braid:

$$\begin{aligned} \text{comb}_B(c_1, c_2) &= \prod_{i=0}^{q-1} \lambda_{n+i,1} a_2 \lambda_{n+i,1}^{-1} \prod_{i=0}^{q-1} \lambda_{n+2q-1-i,1} a_2^{-1} \lambda_{n+2q-1-i,1}^{-1} \\ & \prod_{i=0}^{q-1} \lambda_{n+q+i,1} a_1 \lambda_{n+q+i,1}^{-1} \lambda_{n+q,1} a_2 \lambda_{n,1}^{-1} \lambda_{n+1,n+q} \\ & \prod_{i=1}^{q-1} \lambda_{n+q+i,1} a_2 \lambda_{n,1}^{-1} \lambda_{n+1,n+q} \lambda_{n+q+i,n+q+1}^{-1} \\ & \prod_{i=0}^{q-1} \lambda_{n+q-1-i,1} a_2 \lambda_{n+q-1-i,1}^{-1} \prod_{i=0}^{q-1} \lambda_{n+i,1} a_1 \lambda_{n+i,1}^{-1} \\ & \prod_{i=0}^{q-1} \lambda_{n+i,1} a_2 \lambda_{n+i,1}^{-1} \prod_{i=0}^{q-1} \lambda_{n+i,1} a_1 \lambda_{n+i,1}^{-1} \\ & \prod_{i=0}^{q-1} \lambda_{n+i,1} a_2 \lambda_{n+i,1}^{-1} \prod_{i=0}^{q-1} \lambda_{n+q+i,n+1+i}. \end{aligned}$$

2.7.4 Seifert Manifolds

It is known that a Seifert manifold $M((p_1, q_1), \dots, (p_{m-1}, q_{m-1}))$ has a rational surgery description as shown in Figure 2.29 (see [Sav99], p.33).

Two oriented links in a Seifert manifold $M((p_1, q_1), \dots, (p_{m-1}, q_{m-1}))$ are isotopic if and only if any two corresponding algebraic mixed braids differ by a finite sequence of the moves given in Theorem 2.5, where in particular:

(iv) Combed algebraic braid band moves: For $\beta \in B_{m,n}$ we distinguish the cases:

- If a \mathbb{Q} -braid band move is performed on the j^{th} strand of the fixed braid with rational coefficient p/q (see Figure 2.30) then: $\beta \sim d c_{\pm} \beta' \text{comb}_B(c_j)$, where $\text{comb}_B(c_j)$ is the combing of the c_j cable through B ,

$$d = [\lambda_{n+q-1,1} \alpha_i \lambda_{n-1,1}^{-1}]^p \text{ and } c_{\pm} = \lambda_{n,n+q-1} \sigma_{n+q-1}^{-1} \lambda_{n,n+q-1}^{-1},$$

and where β' is β with the substitutions:

$$\text{For } i > j : a_i^{\pm 1} \longleftrightarrow a_i^{\pm 1},$$

$$\text{For } i < j : a_i^{\pm 1} \longleftrightarrow \lambda_{n-1,1}^{-1} \lambda_{n,n+q-1} \lambda_{n+q-1,1} a_i^{\pm 1} \lambda_{n+q-1,1}^{-1} \lambda_{n,n+q-1}^{-1} \lambda_{n-1,1},$$

$$\text{For } i = j : a_j \longleftrightarrow \lambda_{n-1,1}^{-1} \lambda_{n,n+q-1} \lambda_{n+q-1,1} a_j, \text{ and}$$

$$a_j^{-1} \longleftrightarrow a_j^{-1} \lambda_{n+q-1,1}^{-1} \lambda_{n,n+q-1}^{-1} \lambda_{n-1,1}.$$

- If a \mathbb{Q} -braid band move is performed on the last strand of the fixed braid with surgery coefficient 0, then: $\beta \sim \sigma_n^{\pm 1} \beta'$, where β' is β with the substitutions:

$$a_j^{\pm 1} \longleftrightarrow \lambda_{n-1,1}^{-1} \sigma_n^2 \lambda_{n-1,1} a_j^{\pm 1} \lambda_{n,1}^{-1} \sigma_n^{-1} \lambda_{n-1,1}, \text{ for } j = 1, \dots, m-1,$$

$$a_m \longleftrightarrow \lambda_{n-1,1}^{-1} \sigma_n^2 \lambda_{n-1,1} a_m,$$

$$a_m^{-1} \longleftrightarrow a_m^{-1} \lambda_{n-1,1}^{-1} \sigma_n^{-2} \lambda_{n-1,1}.$$

2.7.5 Rational surgery along a torus knot

It is well-known that a manifold M obtained by rational surgery from S^3 along an (m, r) -torus knot with rational coefficient p/q is either the lens space $L(|q|, pr^2)$, or the connected sum of two lens spaces $L(m, r) \sharp L(r, m)$, or a Seifert manifold (for more details the reader is referred to [Mos71]). For links in M we have:

Two oriented links in M are isotopic if and only if any two corresponding algebraic mixed braids differ by a finite sequence of the moves given in Theorem 2.5, where in particular: (iv) Combed algebraic braid band moves: For $\beta \in B_{m,n}$ we have:

$$\beta \sim d c_{\pm} \beta' \text{comb}_B(c_1, \dots, c_m),$$

where

$$\begin{aligned} d &= [\lambda_{n+mq-1, n+(m-1)q+1} \lambda_{n, n+(m-1)q}^{-1} \lambda_{n-1,1} \alpha_j \lambda_{n-1,1}^{-1} \lambda_{n, n+(m-1)q}]^p, \\ c_{\pm} &= \lambda_{n, n+mq-2} \sigma_{n+mq-1}^{\pm 1} \lambda_{n, n+mq-2}^{-1}, \end{aligned}$$

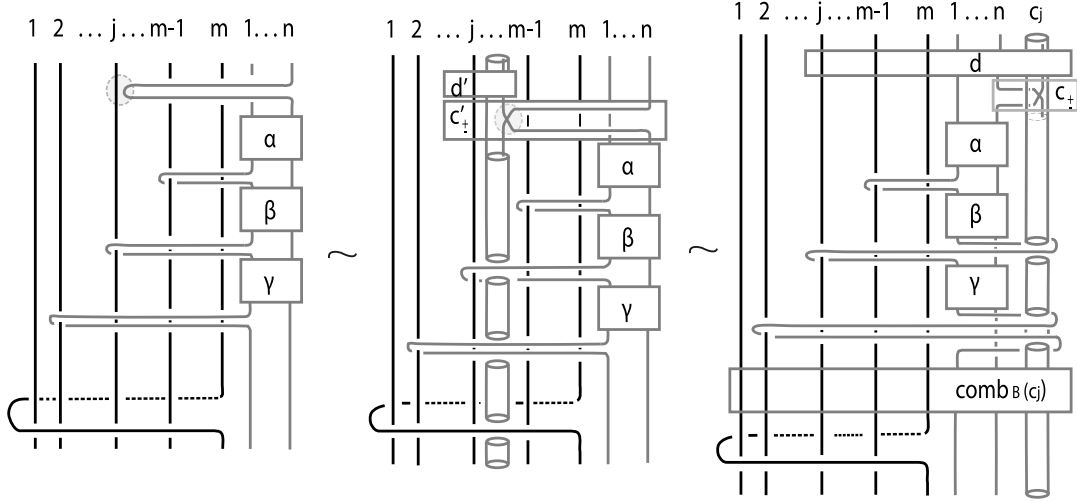

Fig. 2.30: A \mathbb{Q} -braid band move in a Seifert manifold and its algebraic expression.

$comb_B(c_1, \dots, c_m)$ is the combing through the fixed braid braid of the parted moving cables parallel to the surgery strands and β' is the word β with the substitutions:

$$\begin{aligned}
 a_j &\longleftrightarrow \begin{pmatrix} \lambda_{n-1,1}^{-1} & \lambda_{n,n+mq-1} & \lambda_{n+mq-1,n+(j-1)q} & \lambda_{n,n+(j-1)q-1}^{-1} & \lambda_{n-1,1} \\ \lambda_{n-1,1}^{-1} & \lambda_{n,n+jq-1} & \lambda_{n+mq-1,n+jq}^{-1} & \lambda_{n,n+mq-1}^{-1} & \lambda_{n-1,1} \end{pmatrix} a_j \\
 a_j^{-1} &\longleftrightarrow \begin{pmatrix} \lambda_{n-1,1}^{-1} & \lambda_{n,n+mq-1} & \lambda_{n+mq-1,n+jq} & \lambda_{n,n+jq-1}^{-1} & \lambda_{n-1,1} \\ \lambda_{n-1,1}^{-1} & \lambda_{n,n+(j-1)q-1} & \lambda_{n+mq-1,n+(j-1)q}^{-1} & \lambda_{n,n+mq-1}^{-1} & \lambda_{n-1,1} \end{pmatrix} a_j^{-1}, \text{ for } j \in \{1, \dots, m\}.
 \end{aligned}$$

In Figure 2.31 we illustrate an example where the (m, r) -torus knot is the $(2, 3)$ -torus knot, $p = 2$ and $q = 3$ (see Proposition 3.1 in [Mos71] for details about the manifold obtained).

2.7.6 Jones-type invariants and skein modules of 3-manifolds

Our braiding approach is particularly useful for constructing Jones-type invariants and for computing skein modules of 3-manifolds. Jones-type invariants (such as analogues of the Jones polynomial and the 2-variable Jones or HOMFLYPT polynomial) for links in 3-manifolds can be constructed via Markov traces on appropriate quotient algebras (such as analogues of the Temperley-Lieb algebras and the Iwahori-Hecke algebras) of the related mixed braid groups $B_{m,n}$, which support Markov traces. This topological motivation gives rise to many new algebras worth studying. From the Markov trace rules one can obtain link invariants in the complement $S^3 \setminus \widehat{B}$. These invariants can be then extended to link invariants in the manifold $M = \chi(S^3, \widehat{B})$ by forcing them to satisfy all possible band moves. Now, these are more limited if one uses the braiding setting and our Theorem 2.5. A good example and the simplest one demonstrating the

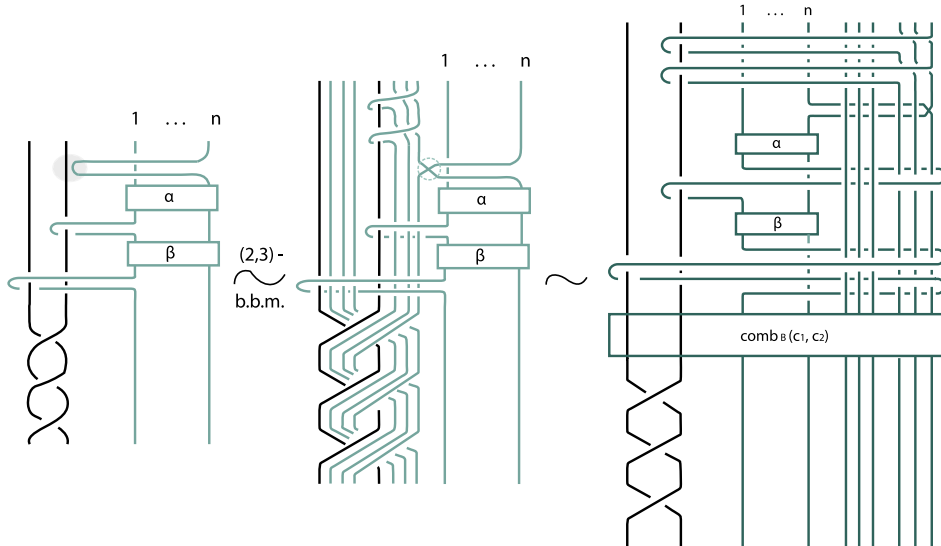

Fig. 2.31: Turning the geometric (2,3)-braid band move into a combed algebraic (2,3)-braid band move.

above is the case of the lens spaces $L(p, 1)$: in [Lam99] the most generic analogue of the Homflypt polynomial, X , for links in the solid torus ST has been derived from the generalized Hecke algebras of type B via a unique Markov trace constructed on them. Hence, X is appropriate for extending the results to the lens spaces $L(p, q)$, since the combinatorial setting is the same as for ST, only the braid equivalence includes the \mathbb{Q} -braid band move, which reflects the surgery description of $L(p, q)$. For the case of $L(p, 1)$, in order to extend X to an invariant of links in $L(p, 1)$ in [IDP] we solve an infinite system of equations resulting from the braid band moves. Namely we force:

$$X_{\hat{\alpha}} = X_{bbm(\hat{\alpha})},$$

for all $\alpha \in \bigcup_{\infty} B_{1,n}$ and for all possible slidings of α . The above equations have particularly simple formulations with the use of a new basis Λ for the Homflypt skein module of ST, that we give in [DL15]. These handle sliding equations are very controlled in the algebraic setting, because they can be performed only on the first moving strand. Further, the infinite system of these equations splits into finite self-contained subsystems. In future work we will use §2.7.2 on the general case of $L(p, q)$ where we have to solve equations of the invariant X which derive by attaching anywhere on a link a 2-handle along a (p, q) -curve. Further, in [KL] the authors are working on connected sums of two lens spaces, constructing the appropriate quotient algebras of the mixed braid groups $B_{2,n}$ and a Markov trace on these algebras.

Our results can be also applied to the study of skein modules of c.c.o. 3-manifolds, using braid techniques. A *skein module* of a 3-manifold, characterized by a given property, is equivalent to finding all possible knot invariants in the 3-manifold characterized by the same property. We are particularly interested in Homflypt skein modules of 3-manifolds, although our approach can be also used for computing other skein modules

of 3-manifolds such as Kauffman bracket skein modules. We note that the computation of a Homflypt skein module of a 3-manifold M with the use of diagrammatic methods is very complicated. The advantage of the algebraic setting is that it gives more control over the band moves than the diagrammatic approach and much of the diagrammatic complexity is absorbed into the proofs of the algebraic statements. We only need to consider one type of orientations patterns and the braid band moves are limited. To draw the analogy in the simplest situation: in [Lam99] the Homflypt skein module of the solid torus $S(\text{ST})$ ([Tur88, HK90]) has been recovered from the invariant X mentioned above. $S(\text{ST})$ is related to $S(L(p, q))$. The unique solution of the infinite system of the sliding equations satisfied by X reflects the freeness of $S(L(p, 1))$. As a consequence of the above, in [?] we work on computing $S(L(p, q))$ in the general case using our results of §2.7.2.

2.7.7 Application to the equivalence of 3-manifolds

In [KS92] the authors prove a braid version of the Kirby calculus, namely an equivalence relation between framed braids that represent homeomorphic 3-manifolds. As mentioned in the introduction, although every c.c.o. 3-manifold can be obtained by integral surgery along a link L in S^3 , it is sometimes more convenient to consider rational surgery description for a c.c.o. 3-manifold. Rolfsen [Rol84] extended the Kirby calculus to rational surgery coefficients, giving rise to the *Rational calculus* and introducing a handle sliding move called *Rolfsen twist*. It would be useful to extend the result in [KS92] and derive the braid analogue of the Rolfsen calculus. The braid analogue of the Rolfsen twist is precisely the \mathbb{Q} -braid band move (Definition 2.4). The difference here is that there are no fixed and moving strands in the setting; all braids involved are surgery braids. Moreover, when applying a \mathbb{Q} -braid band move along a component, the framings of the strands involved, will change, as shown in [Rol84]. The braid moves reflecting framed link isotopy in S^3 as well as the blow up move are the same as in [KS92]. The difficulty in carrying through the braid analogue for the Rational calculus lies in the following: Since Kirby calculus as well as Rational calculus are applied to non-oriented links in S^3 , and since the orientation of a link L is crucial in order to obtain its braid representation, one has to consider additionally how the change of orientation of any component of L would alter the surgery braid. For the case of integral surgery, as shown in [KS92], one may unknot the component that the change of orientation will occur, by applying Fenn-Rourke moves, then change the orientation of the component, and finally undo all Fenn-Rourke moves applied before. The result is a link L' , that differs from L by a change of orientation of one component. For the case of rational surgery, this is a very complicated problem and will be the subject of future research.

Combining the above with the Kauffman bracket skein module of a 3-manifold, our results could potentially lead to a uniform algebraic approach to the Witten invariants.

A NEW BASIS FOR THE HOMFLYPT SKEIN MODULE OF THE SOLID TORUS

In this chapter we give a new basis, Λ , for the Homflypt skein module of the solid torus, $S(\text{ST})$, which topologically is compatible with the handle sliding moves and which was predicted by J.H.Przytycki. The basis Λ is different from the basis Λ' , discovered independently by Hoste–Kidwell [HK90] and Turaev [Tur88] with the use of diagrammatic methods, and also different from the basis of Morton–Aiston [MA97]. For finding the basis Λ we use the generalized Hecke algebra of type B, $H_{1,n}$, which is generated by looping elements and braiding elements and which is related to the affine Hecke algebra of type A [Lam99]. More precisely, we start with the well-known basis Λ' of $S(\text{ST})$ and an appropriate linear basis Σ_n of the algebra $H_{1,n}$. We then convert elements in Λ' to sums of elements in Σ_n . Then, using conjugation and the stabilization moves, we convert these elements to sums of elements in Λ by managing gaps in the indices, by ordering the exponents of the looping elements and by eliminating braiding tails in the words. Further, we define total orderings on the sets Λ' and Λ and, using these orderings, we relate the two sets via a block diagonal matrix, where each block is an infinite lower triangular matrix with invertible elements in the diagonal. Using this matrix we prove linear independence of the set Λ , thus Λ is a basis for $S(\text{ST})$.

$S(\text{ST})$ plays an important role in the study of Homflypt skein modules of arbitrary c.c.o. 3-manifolds, since every c.c.o. 3-manifold can be obtained by integral surgery along a framed link in S^3 with unknotted components. In particular, the new basis of $S(\text{ST})$ is appropriate for computing the Homflypt skein module of the lens spaces. In this paper we provide some basic algebraic tools for computing skein modules of c.c.o. 3-manifolds via algebraic means.

3.1 Introduction

Let ST denote the solid torus. In [Tur88], [HK90] the Homflypt skein module of the solid torus has been computed using diagrammatic methods by means of the following

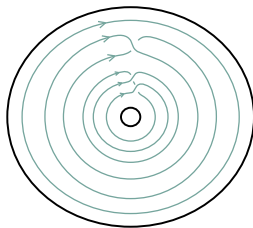

Fig. 3.1: A basic element of $S(\text{ST})$.

theorem:

Theorem 3.1 (Turaev, Kidwell–Hoste). *The skein module $S(\text{ST})$ is a free, infinitely generated $\mathbb{Z}[u^{\pm 1}, z^{\pm 1}]$ -module isomorphic to the symmetric tensor algebra $SR\widehat{\pi}^0$, where $\widehat{\pi}^0$ denotes the conjugacy classes of non trivial elements of $\pi_1(\text{ST})$.*

A basic element of $S(\text{ST})$ in the context of [Tur88, HK90], is illustrated in Figure 3.1. In the diagrammatic setting of [Tur88] and [HK90], ST is considered as $\text{Annulus} \times \text{Interval}$. The Homflypt skein module of ST is particularly important, because any closed, connected, oriented (c.c.o.) 3-manifold can be obtained by surgery along a framed link in S^3 with unknotted components.

A different basis of $S(\text{ST})$, known as Young idempotent basis, is based on the work of Morton and Aiston [MA97] and Blanchet [Bla00].

In [Lam99], $S(\text{ST})$ has been recovered using algebraic means. More precisely, the generalized Hecke algebra of type B, $H_{1,n}(q)$, is introduced, which is isomorphic to the affine Hecke algebra of type A, $\widetilde{H}_n(q)$. Then, a unique Markov trace is constructed on the algebras $H_{1,n}(q)$ leading to an invariant for links in ST , the universal analogue of the Homflypt polynomial for ST . This trace gives distinct values on distinct elements of the [Tur88, HK90]-basis of $S(\text{ST})$. The link isotopy in ST , which is taken into account in the definition of the skein module and which corresponds to conjugation and the stabilization moves on the braid level, is captured by the conjugation property and the Markov property of the trace, while the defining relation of the skein module is reflected into the quadratic relation of $H_{1,n}(q)$. In the algebraic language of [Lam99] the basis of $S(\text{ST})$, described in Theorem 3.1, is given in open braid form by the set Λ' in Eq. 1.5. Figure 1.19 illustrates the basic element of Figure 3.1 in braid notation. Note that in the setting of [Lam99] ST is considered as the complement of the unknot (the bold curve in the figure). The looping elements $t'_i \in H_{1,n}(q)$ in the monomials of Λ' are all conjugates, so they are consistent with the trace property and they enable the definition of the trace via simple inductive rules.

In this chapter we present a new basis Λ for $S(\text{ST})$, which was predicted by J.H. Przytycki, using the algebraic methods developed in [Lam99]. The motivation of this work is the computation of $S(L(p, q))$ via algebraic means. The new basic set is described in Eq. 3.1 in open braid form. The looping elements t_i are in the algebras $H_{1,n}(q)$ and they are commuting. For a comparative illustration and for the defining

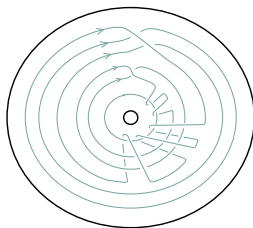

Fig. 3.2: An element of the new basis Λ .

formulas of the t_i 's and the t'_i 's the reader is referred to Figure 1.11. Moreover, the t_i 's are consistent with the handle sliding move or band move used in the link isotopy in $L(p, q)$, in the sense that a braid band move can be described naturally with the use of the t_i 's (see for example [DL15] and references therein).

Our main result is the following:

Theorem 3.2. *The following set is a $\mathbb{Z}[q^{\pm 1}, z^{\pm 1}]$ -basis for $S(\text{ST})$:*

$$\Lambda = \{t^{k_0} t_1^{k_1} \dots t_n^{k_n}, k_i \in \mathbb{Z} \setminus \{0\}, k_i \geq k_{i+1} \forall i, n \in \mathbb{N}\}. \quad (3.1)$$

Our method for proving Theorem 3.2 is the following:

- We define total orderings in the sets Λ' and Λ ,
- we show that the two ordered sets are related via a lower triangular infinite matrix with invertible elements on the diagonal, and
- using this matrix, we show that the set Λ is linearly independent.

More precisely, two analogous sets, Σ_n and Σ'_n , are given in [Lam99] as linear bases for the algebra $H_{1,n}(q)$. See Theorem 1.8 in this paper. The set $\bigcup_n \Sigma_n$ includes Λ as a proper subset and the set $\bigcup_n \Sigma'_n$ includes Λ' as a proper subset. The sets Σ_n come directly from the works of S. Ariki and K. Koike, and M. Broué and G. Malle on the cyclotomic Hecke algebras of type B. See [Lam99] and references therein. The second set $\bigcup_n \Sigma'_n$ includes Λ' as a proper subset. The sets Σ'_n appear naturally in the structure of the braid groups of type B, $B_{1,n}$; however, it is very complicated to show that they are indeed basic sets for the algebras $H_{1,n}(q)$. The sets Σ_n play an intrinsic role in the proof of Theorem 3.2. Indeed, when trying to convert a monomial λ' from Λ' into a linear combination of elements in Λ we pass by elements of the sets Σ_n . This means that in the converted expression of λ' we have monomials in the t_i 's, with possible gaps in the indices and possible non ordered exponents followed by monomials in the braiding generators g_i . So, in order to reach expressions in the set Λ we need:

- to manage the gaps in the indices of the t_i 's,
- to order the exponents of the t_i 's and
- to eliminate the braiding 'tails'.

This chapter is organized as follows. In Section 4.3 we define the orderings in the two sets Σ_n and Σ'_n , which include the sets Λ and Λ' as subsets, and we prove that

these sets are totally ordered. In Section 3.3 we prove a series of lemmas for converting elements in Λ' to elements in the sets Σ_n . In Section 3.4 we convert elements in Σ_n to elements in Λ using conjugation and the stabilization moves. Finally, in Section 3.5 we prove that the sets Λ' and Λ are related through a lower triangular infinite matrix mentioned above and that the set Λ is linearly independent.

The algebraic techniques developed here will serve as basis for computing Homflypt skein modules of arbitrary c.c.o. 3-manifolds using the braid approach. The advantage of this approach is that we have an already developed homogeneous theory of braid structures and braid equivalences for links in c.c.o. 3-manifolds ([LR97, LR06, DL15]). In fact, these algebraic techniques are used and developed further in [KL] for knots and links in 3-manifolds represented by the 2-unlink.

3.2 An ordering in the sets Λ and Λ'

In this section we define an ordering relation in the sets Σ'_n and Σ_n , which include Λ' and Λ as subsets. Before that, we will need the notion of the index of a word in Λ' or in Λ .

Definition 3.1. The *index* of a word w in Λ' or in Λ , denoted $ind(w)$, is defined to be the highest index of the t'_i 's, resp. of the t_i 's, in w . Similarly, the *index* of an element in Σ'_n or in Σ_n is defined in the same way by ignoring possible gaps in the indices of the looping generators and by ignoring the braiding part in $H_n(q)$. Moreover, the index of a monomial in $H_n(q)$ is equal to 0.

For example, $ind(t'^{k_0} t_1^{k_1} \dots t_n^{k_n}) = ind(t^{u_0} \dots t_n^{u_n}) = n$.

Definition 3.2. We define the following *ordering* in the sets Σ'_n .

Let $w = t'_{i_1}{}^{k_1} t'_{i_2}{}^{k_2} \dots t'_{i_\mu}{}^{k_\mu}$ and $\sigma = t'_{j_1}{}^{\lambda_1} t'_{j_2}{}^{\lambda_2} \dots t'_{j_\nu}{}^{\lambda_\nu}$, where $k_t, \lambda_s \in \mathbb{Z}$, for all t, s . Then:

- (a) If $\sum_{i=0}^{\mu} k_i < \sum_{i=0}^{\nu} \lambda_i$, then $w < \sigma$.
- (b) If $\sum_{i=0}^{\mu} k_i = \sum_{i=0}^{\nu} \lambda_i$, then:
 - (i) if $ind(w) < ind(\sigma)$, then $w < \sigma$,
 - (ii) if $ind(w) = ind(\sigma)$, then:
 - (α) if $i_1 = j_1, i_2 = j_2, \dots, i_{s-1} = j_{s-1}, i_s < j_s$, then $w > \sigma$,
 - (β) if $i_t = j_t \forall t$ and $k_\mu = \lambda_\mu, k_{\mu-1} = \lambda_{\mu-1}, \dots, k_{i+1} = \lambda_{i+1}, |k_i| < |\lambda_i|$, then $w < \sigma$,
 - (γ) if $i_t = j_t \forall t$ and $k_\mu = \lambda_\mu, k_{\mu-1} = \lambda_{\mu-1}, \dots, k_{i+1} = \lambda_{i+1}, |k_i| = |\lambda_i|$ and $k_i > \lambda_i$, then $w < \sigma$,
 - (δ) if $i_t = j_t \forall t$ and $k_i = \lambda_i, \forall i$, then $w = \sigma$.

- (c) In the general case where $w = t'_{i_1}{}^{k_1} t'_{i_2}{}^{k_2} \dots t'_{i_m}{}^{k_m} \cdot \beta_1$ and $\sigma = t'_{j_1}{}^{\lambda_1} t'_{j_2}{}^{\lambda_2} \dots t'_{j_n}{}^{\lambda_n} \cdot \beta_2$, where $\beta_1, \beta_2 \in H_n(q)$, the ordering is defined in the same way by ignoring the braiding parts β_1, β_2 .

The same ordering is defined on the set Λ' by ignoring the braiding parts. Moreover, the same ordering is defined on the sets Σ_n and Λ , where the t'_i 's are replaced by the corresponding t_i 's.

Proposition 3.1. *The set Σ_n' equipped with the ordering given in Definition 3.2, is a totally ordered set.*

Proof. In order to show that the set Σ_n' is totally a ordered set when equipped with the ordering given in Definition 3.2, we need to show that the ordering relation is anti-symmetric, transitive and total. We only show that the ordering relation is transitive. Antisymmetric property follows similarly. Totality follows from Definition 3.2 since all possible cases have been considered. Let $w, \sigma, v \in \Sigma_n$ such that:

$$w = t'_{i_1}{}^{k_1} t'_{i_2}{}^{k_2} \dots t'_{i_m}{}^{k_m} \cdot \beta_1,$$

$$\sigma = t'_{j_1}{}^{\lambda_1} t'_{j_2}{}^{\lambda_2} \dots t'_{j_n}{}^{\lambda_n} \cdot \beta_2,$$

$$v = t'_{\phi_1}{}^{\mu_1} t'_{\phi_2}{}^{\mu_2} \dots t'_{\phi_p}{}^{\mu_p} \cdot \beta_3,$$

where $\beta_1, \beta_2, \beta_3 \in H_n(q)$ and let $w < \sigma$ and $\sigma < v$. Since $w < \sigma$, one of the following holds:

- (a) Either $\sum_{i=1}^m k_i < \sum_{i=1}^n \lambda_i$ and since $\sigma < v$, we have that $\sum_{i=1}^n \lambda_i \leq \sum_{i=1}^p \mu_i$ and so $\sum_{i=1}^m k_i < \sum_{i=1}^p \mu_i$. Thus $w < v$.
- (b) Either $\sum_{i=1}^m k_i = \sum_{i=1}^n \lambda_i$ and $ind(w) = m < n = ind(\sigma)$. Then, since $\sigma < v$ we have that either $\sum_{i=1}^n \lambda_i < \sum_{i=1}^p \mu_i$ (same as in case (a)) or $\sum_{i=1}^n \lambda_i = \sum_{i=1}^p \mu_i$ and $ind(\sigma) \leq p = ind(v)$. Thus, $ind(w) = m < p = ind(v)$ and so we conclude that $w < v$.
- (c) Either $\sum_{i=1}^m k_i = \sum_{i=1}^n \lambda_i$, $ind(w) = ind(\sigma)$ and $i_1 = j_1, \dots, i_{s-1} = j_{s-1}, i_s > j_s$. Then, since $\sigma < v$, we have that either:
- $\sum_{i=1}^n \lambda_i < \sum_{i=1}^p \mu_i$, same as in case (a), or
 - $\sum_{i=1}^n \lambda_i = \sum_{i=1}^p \mu_i$ and $ind(\sigma) < ind(v)$, same as in case (b), or
 - $ind(\sigma) = ind(v)$ and $j_1 = \varphi_1, \dots, j_p > \varphi_p$. Then:
 - (i) if $p = s$ we have that $i_s > j_s > \varphi_s$ and we conclude that $w < v$.
 - (ii) if $p < s$ we have that $i_p = j_p > \varphi_p$ and thus $w < v$ and if $s < p$ we have that $i_s > j_s = \varphi_s$ and so $w < v$.

- (d) Either $\sum_{i=1}^m k_i = \sum_{i=1}^n \lambda_i$, $ind(w) = ind(\sigma)$ and $k_n = \lambda_n, \dots, |k_q| < |\lambda_q|$. Then, since $\sigma < v$, we have that either:
- $\sum_{i=1}^n \lambda_i < \sum_{i=1}^p \mu_i$, same as in case (a), or
 - $\sum_{i=1}^n \lambda_i = \sum_{i=1}^p \mu_i$ and $ind(\sigma) < ind(v)$, same as in case (b), or
 - $ind(\sigma) = ind(v)$ and $j_1 = \varphi_1, \dots, j_q > \varphi_q$, same as in case (c), or
 - $j_n = \varphi_n$, for all n and $\mu_n = \lambda_n, \dots, \mu_{c+1} = \lambda_{c+1}, |\mu_c| \geq |\lambda_c|$ for some c , then:
 - (1) If $|\mu_c| > |\lambda_c|$, then:
 - (i) If $c > q$ then $|k_c| = |\lambda_c| < |\mu_c|$ and thus $w < v$.
 - (ii) If $c < q$ then $|k_q| < |\lambda_q| = |\mu_q|$ and thus $w < v$.
 - (iii) If $c = q$ then $|k_q| < |\lambda_q| < |\mu_q|$ and thus $w < v$.
 - (2) If $|\mu_c| = |\lambda_c|$, such that $\mu_c < \lambda_c$, then:
 - (i) If $c > q$ then $|k_c| = |\lambda_c| = |\mu_c|$ and $k_c = \lambda_c > \mu_c$. Thus $w < v$.
 - (ii) If $c \leq q$ then $|k_q| < |\lambda_q| = |\mu_q|$ and thus $w < v$.
- (e) Either $\sum_{i=1}^m k_i = \sum_{i=1}^n \lambda_i$, $ind(w) = ind(\sigma)$ and $k_n = \lambda_n, \dots, |k_q| = |\lambda_q|$, such that $k_q > \lambda_q$. Then, since $\sigma < v$, we have that either:
- $\sum_{i=1}^n \lambda_i < \sum_{i=1}^p \mu_i$, same as in case (a), or
 - $\sum_{i=1}^n \lambda_i = \sum_{i=1}^p \mu_i$ and $ind(\sigma) < ind(v)$, same as in case (b), or
 - $ind(\sigma) = ind(v)$ and $j_1 = \varphi_1, \dots, j_q > \varphi_q$, same as in case (c), or
 - $j_n = \varphi_n$, for all n and $\mu_n = \lambda_n, \dots, \mu_{c+1} = \lambda_{c+1}, |\mu_c| \geq |\lambda_c|$ for some c , then:
 - (1) If $|\mu_c| > |\lambda_c|$, then:
 - (i) If $c > q$ then $|k_c| = |\lambda_c| < |\mu_c|$, thus $w < v$.
 - (ii) If $c \leq q$ then $|k_q| = |\lambda_q| = |\mu_q|$ and $k_q > \lambda_q = \mu_q$, thus $w < v$.
 - (2) If $|\mu_c| = |\lambda_c|$ such that $\lambda_c > \mu_c$, then:
 - (i) If $c > q$ then $|k_c| = |\lambda_c| = |\mu_c|$ and $k_c = \lambda_c > \mu_c$, thus $w < v$.
 - (ii) If $c < q$ then $|k_q| = |\lambda_q| = |\mu_q|$ and $k_q > \lambda_q = \mu_q$, thus $w < v$.
 - (iii) If $c = q$, then $|k_q| = |\lambda_q| = |\mu_q|$ and $k_q > \lambda_q > \mu_q$, thus $w < v$.

So, we conclude that the ordering relation is transitive. □

Remark 3.1. Proposition 3.1 also holds for the sets Σ_n , Λ' and Λ .

Definition 3.3. We define the subset of *level* k , Λ_k , of Λ to be the set

$$\Lambda_k := \{t^{k_0} t_1^{k_1} \dots t_m^{k_m} \mid \sum_{i=0}^m k_i = k, k_i \in \mathbb{Z} \setminus \{0\}, k_i \geq k_{i+1} \forall i\}$$

and similarly, the subset of *level* k of Λ' to be

$$\Lambda'_k := \{t^{k_0} t_1^{k_1} \dots t_m^{k_m} \mid \sum_{i=0}^m k_i = k, k_i \in \mathbb{Z} \setminus \{0\}, k_i \geq k_{i+1} \forall i\}.$$

Remark 3.2. Let $w \in \Lambda_k$ a monomial containing gaps in the indices and $u \in \Lambda_k$ a monomial with consecutive indices such that $\text{ind}(w) = \text{ind}(u)$. Then, it follows from Definition 3.2 that $w < u$.

Proposition 3.2. *The sets Λ_k are totally ordered and well-ordered for all k .*

Proof. Since $\Lambda_k \subseteq \Lambda$, $\forall k$, Λ_k inherits the property of being a totally ordered set from Λ . Moreover, t^k is the minimum element of Λ_k and so Λ_k is a well-ordered set. \square

We also introduce the notion of *homologous words* as follows:

Definition 3.4. We shall say that two words $w' \in \Lambda'$ and $w \in \Lambda$ are *homologous*, denoted $w' \sim w$, if w is obtained from w' by turning t'_i into t_i for all i .

With the above notion the proof of Theorem 3.2 is based on the following idea: Every element $w' \in \Lambda'$ can be expressed as linear combinations of monomials $w_i \in \Lambda$ with coefficients in \mathbb{C} , such that:

- (i) $\exists j$ such that $w_j \sim w'$,
- (ii) $w_j < w_i$, for all $i \neq j$,
- (iii) the coefficient of w_j is an invertible element in \mathbb{C} .

3.3 From Λ' to Σ_n

In this section we prove a series of lemmas relating elements of the two different basic sets Σ_n, Σ'_n of $H_{1,n}(q)$. In the proofs we underline expressions which are crucial for the next step. Since Λ' is a subset of Σ'_n , all lemmas proved here apply also to Λ' and will be used in the context of the bases of $\mathcal{S}(\text{ST})$.

3.3.1 Some useful lemmas in $H_{1,n}(q)$

We will need the following results from [Lam99]. The first lemma gives some basic relations of the braiding generators.

Lemma 3.1 (Lemma 1 [Lam99]). *For $\epsilon \in \{\pm 1\}$ the following hold in $H_{1,n}(q)$:*

- (i) $g_i^m = (q^{m-1} - q^{m-2} + \dots + (-1)^{m-1}) g_i + (q^{m-1} - q^{m-2} + \dots + (-1)^{m-2} q)$
 $g_i^{-m} = (q^{-m} - q^{1-m} + \dots + (-1)^{m-1} q^{-1}) g_i +$
 $+ (q^{-m} - q^{1-m} + \dots + (-1)^{m-1} q^{-1} + (-1)^m)$
- (ii) $g_i^\epsilon (g_k^{\pm 1} g_{k-1}^{\pm 1} \dots g_j^{\pm 1}) = (g_k^{\pm 1} g_{k-1}^{\pm 1} \dots g_j^{\pm 1}) g_{i+1}^\epsilon$, for $k > i \geq j$,
 $g_i^\epsilon (g_j^{\pm 1} g_{j+1}^{\pm 1} \dots g_k^{\pm 1}) = (g_j^{\pm 1} g_{j+1}^{\pm 1} \dots g_k^{\pm 1}) g_{i-1}^\epsilon$, for $k \geq i > j$,

where the sign of the ± 1 exponent is the same for all generators.

- (iii) $g_i g_{i-1} \cdots g_{j+1} g_j g_{j+1} \cdots g_i = g_j g_{j+1} \cdots g_{i-1} g_i g_{i-1} \cdots g_{j+1} g_j$
 $g_i^{-1} g_{i-1}^{-1} \cdots g_{j+1}^{-1} g_j^\epsilon g_{j+1}^\epsilon \cdots g_i = g_j g_{j+1} \cdots g_{i-1} g_i^\epsilon g_{i-1}^{-1} \cdots g_{j+1}^{-1} g_j^{-1}$
- (iv) $g_i^\epsilon \cdots g_{n-1}^\epsilon g_n^{2\epsilon} g_{n-1}^\epsilon \cdots g_i^\epsilon = \sum_{r=0}^{n-i+1} (q^\epsilon - 1)^{\epsilon r} q^{\epsilon r} (g_i^\epsilon \cdots g_{n-r}^\epsilon \cdots g_i^\epsilon)$,
where $\epsilon_r = 1$ if $r \leq n - i$ and $\epsilon_{n-i+1} = 0$. Similarly,
- (v) $g_i^\epsilon \cdots g_2^\epsilon g_1^{2\epsilon} g_2^\epsilon \cdots g_i^\epsilon = \sum_{r=0}^i (q^\epsilon - 1)^{\epsilon r} q^{\epsilon r} (g_i^\epsilon \cdots g_{r+2}^\epsilon g_{r+1}^\epsilon g_{r+2}^\epsilon \cdots g_i^\epsilon)$,
where $\epsilon_r = 1$ if $r \leq i - 1$ and $\epsilon_i = 0$.

The next lemma comprises relations between the braiding generators and the looping generator t .

Lemma 3.2 (cf. Lemmas 1, 4, 5 [Lam99]). *For $\epsilon \in \{\pm 1\}$, $i, k \in \mathbb{N}$ and $\lambda \in \mathbb{Z}$ the following hold in $H_{1,n}(q)$:*

$$\begin{aligned}
(i) \quad t^\lambda g_1 t g_1 &= g_1 t g_1 t^\lambda \\
(ii) \quad t^\epsilon g_1^\epsilon t^{\epsilon k} g_1^\epsilon &= g_1^{\epsilon t^{\epsilon k}} g_1^\epsilon t^\epsilon + (q^\epsilon - 1) t^\epsilon g_1^\epsilon t^{\epsilon k} + (1 - q^\epsilon) t^{\epsilon k} g_1^\epsilon t^\epsilon \\
t^{-\epsilon} g_1^{\epsilon t^{\epsilon k}} g_1^\epsilon &= g_1^{\epsilon t^{\epsilon k}} g_1^\epsilon t^{-\epsilon} + (q^\epsilon - 1) t^{\epsilon(k-1)} g_1^\epsilon + (1 - q^\epsilon) g_1^{\epsilon t^{\epsilon(k-1)}} \\
(iii) \quad t^{\epsilon i} g_1^\epsilon t^{\epsilon k} g_1^\epsilon &= g_1^{\epsilon t^{\epsilon k}} g_1^{\epsilon t^{\epsilon i}} + (q^\epsilon - 1) \sum_{j=1}^i t^{\epsilon j} g_1^{\epsilon t^{\epsilon(k+i-j)}} + \\
&+ (1 - q^\epsilon) \sum_{j=0}^{i-1} t^{\epsilon(k+j)} g_1^{\epsilon t^{\epsilon(i-j)}} \\
t^{-\epsilon i} g_1^{\epsilon t^{\epsilon k}} g_1^\epsilon &= g_1^{\epsilon t^{\epsilon k}} g_1^{\epsilon t^{-\epsilon i}} + (q^\epsilon - 1) \sum_{j=1}^i t^{\epsilon(k-j)} g_1^{\epsilon t^{-\epsilon(i-j)}} + \\
&+ (1 - q^\epsilon) \sum_{j=1}^i t^{\epsilon(i-j)} g_1^{\epsilon t^{\epsilon(k-j)}}
\end{aligned}$$

The next lemma gives the interactions of the braiding generators and the loopings t_i s and t'_i s.

Lemma 3.3 (Lemmas 1 and 2 [Lam99]). *The following relations hold in $H_{1,n}(q)$:*

$$\begin{aligned}
(i) \quad g_i t_k^\epsilon &= t_k^\epsilon g_i \text{ for } k > i, k < i - 1 \\
g_i t_i &= q t_{i-1} g_i + (q - 1) t_i \\
g_i t_{i-1} &= q^{-1} t_i g_i + (q^{-1} - 1) t_i = t_i g_i^{-1} \\
g_i t_{i-1}^{-1} &= q t_{i-1}^{-1} g_i + (q - 1) t_{i-1}^{-1} \\
g_i t_i^{-1} &= q^{-1} t_{i-1}^{-1} g_i + (q^{-1} - 1) t_{i-1}^{-1} = t_{i-1}^{-1} g_i^{-1} \\
(ii) \quad t_n^k g_n &= (q - 1) \sum_{j=0}^{k-1} q^j t_{n-1}^j t_n^{k-j} + q^k g_n t_{n-1}^k, \text{ if } k \in \mathbb{N} \\
t_n^k g_n &= (1 - q) \sum_{j=0}^{k-1} q^j t_{n-1}^j t_n^{k-j} + q^k g_n t_{n-1}^k, \text{ if } k \in \mathbb{Z} - \mathbb{N} \\
(iii) \quad t_i^k t_j^\lambda &= t_j^\lambda t_i^k \text{ for } i \neq j \text{ and } k, \lambda \in \mathbb{Z} \\
(iv) \quad g_i t'_k^\epsilon &= t'_k^\epsilon g_i \text{ for } k > i, k < i - 1 \\
g_i t'_i^\epsilon &= t'_{i-1}^\epsilon g_i + (q - 1) t'_i^\epsilon + (1 - q) t'_{i-1}^\epsilon \\
g_i t'_{i-1}^\epsilon &= t'_i^\epsilon g_i \\
(v) \quad t_i^k &= g_i \cdots g_1 t^k g_1^{-1} \cdots g_i^{-1} \text{ for } k \in \mathbb{Z}.
\end{aligned}$$

Using now Lemmas 3.1, 3.2 and 3.3 we prove the following relations, which we will use for converting elements in Λ' to elements in Σ_n . Note that whenever a generator is overlined, this means that the specific generator is omitted from the word.

Lemma 3.4. *The following relations hold in $H_{1,n}(q)$ for $k \in \mathbb{N}$:*

$$\begin{aligned} (i) \quad g_{m+1}t_m^k &= q^{-(k-1)}t_{m+1}^k g_{m+1}^{-1} + \sum_{j=1}^{k-1} q^{-(k-1-j)}(q^{-1} - 1)t_m^j t_{m+1}^{k-j}, \\ (ii) \quad g_{m+1}^{-1}t_m^{-k} &= q^{(k-1)}t_{m+1}^{-k} g_{m+1} + \sum_{j=1}^{k-1} q^{(k-1-j)}(q - 1)t_m^{-j} t_{m+1}^{-(k-j)}. \end{aligned}$$

Proof. We prove relations (i) by induction on k . Relations (ii) follow similarly. For $k = 1$ we have that $g_{m+1}t_m = t_{m+1}g_{m+1}^{-1}$, which holds from Lemma 3.3 (i). Suppose that the relation holds for $k - 1$. Then, for k we have:

$$g_{m+1}t_m^k = g_{m+1}t_m^{k-1}t_m \stackrel{\text{ind. step}}{=} q^{-(k-2)}t_{m+1}^{k-1}g_{m+1}^{-1}t_m +$$

$$+ \sum_{j=1}^{k-2} q^{-(k-2-j)}(q^{-1} - 1)t_m^j t_{m+1}^{k-1-j}t_m =$$

$$= q^{1-k}g_{m+1}t_m + q^{2-k}(q^{-1} - 1)t_m t_{m+1}^{k-1} + \sum_{j=1}^{k-2} q^{-(k-2-j)}(q^{-1} - 1)t_m^{j+1}t_{m+1}^{k-1-j}$$

$$= q^{-(k-1)}t_{m+1}g_{m+1}^{-1} + \sum_{j=1}^k q^{-(k-1-j)}(q^{-1} - 1)t_m^j t_{m+1}^{k-j}. \quad \square$$

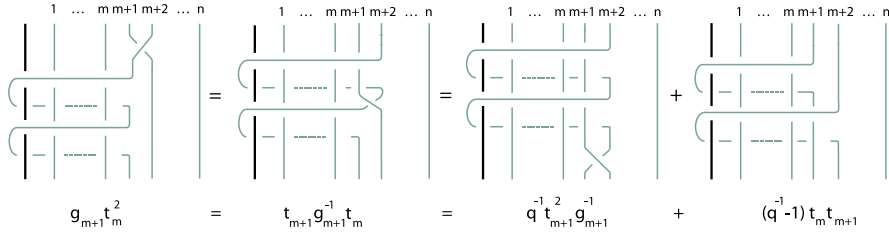

Fig. 3.3: Illustrating Lemma 4(i) for $k = 2$.

Lemma 3.5. *In $H_{1,n}(q)$ the following relations hold:*

(i) *For the expression $A = (g_r g_{r-1} \dots g_{r-s}) \cdot t_k$ the following hold for the different values of $k \in \mathbb{N}$:*

- (1) $A = t_k (g_r \dots g_{r-s})$ for $k > r$ or $k < r - s - 1$
- (2) $A = t_r (g_r^{-1} \dots g_{r-s}^{-1})$ for $k = r - s - 1$
- (3) $A = qt_{r-1} (g_r \dots g_{r-s}) + (q - 1)t_r (g_{r-1} \dots g_{r-s})$ for $k = r$
- (4) $A = qt_{r-s-1} (g_r \dots g_{r-s}) + (q - 1)t_r (g_r^{-1} \dots g_{r-s+1}^{-1})$ for $k = r - s$
- (5) $A = t_{m-1} (g_r \dots g_{r-s}) + (q - 1)t_r (g_r^{-1} \dots g_{m+1}^{-1}) (g_{m-1} \dots g_{r-s})$ for $k = m \in \{r - s + 1, \dots, r - 1\}$.

(ii) *For the expression $A = (g_r g_{r-1} \dots g_{r-s}) \cdot t_k^{-1}$ the following hold for the different values of $k \in \mathbb{N}$:*

- (1) $A = t_k^{-1} (g_r \dots g_{r-s})$ for $k > r$ or $k < r - s - 1$
- (2) $A = t_{r-s-1}^{-1} (g_r \dots g_{r-s+1} g_{r-s}^{-1})$ for $k = r - s$
- (3) $A = t_{m-1}^{-1} (g_r g_{r-1} \dots g_{m+1} g_m^{-1} g_{m-1} \dots g_{k-s})$ for $k = m \in \{r - s + 1, \dots, r\}$
- (4) $A = q^{s+1}t_r^{-1} (g_r \dots g_{r-s}) + (q - 1) \sum_{j=1}^{s+1} q^{s-j+1} t_{r-j}^{-1} \cdot (g_r \dots g_{r-j+2} g_{r-j} \dots g_{r-s})$ for $k = r - s - 1$.

Proof. We only prove relations (ii) for $k = r - s - 1$ by induction on s (case 4). All other relations follow from Lemma 3.3 (i).

For $s = 1$ we have:

$$\begin{aligned} g_r \underline{g_{r-1} t_{r-2}^{-1}} &= g_r [q t_{r-1}^{-1} g_{r-1} + (q-1) t_{r-2}^{-1}] = q g_r t_{r-1}^{-1} g_{r-1} + (q-1) g_r t_{r-2}^{-1} \\ &= q [q t_r^{-1} g_r + (q-1) t_{r-1}^{-1}] g_{r-1} + (q-1) t_{r-2}^{-1} g_r \\ &= q^2 t_r^{-1} (g_r g_{r-1}) + (q-1) [q t_{r-1}^{-1} g_{r-1} + q^0 t_{r-2}^{-1} g_r], \end{aligned}$$

and so the relation holds for $s = 1$. Suppose that the relation holds for $s = n$. We will show that it holds for $s = n + 1$. Indeed we have:

$$\begin{aligned} (g_r \cdots g_{r-n-1}) t_{r-n-2}^{-1} &= (g_r \cdots g_{r-n}) (g_{r-n-1} t_{r-n-2}^{-1}) = \\ (g_r \cdots g_{r-n}) [q t_{r-n-1}^{-1} g_{r-n-1} + (q-1) t_{r-n-2}^{-1}] &= \\ = q (g_r \cdots g_{r-n} t_{r-n-1}^{-1}) g_{r-n-1} + (q-1) (g_r \cdots g_{r-n}) t_{r-n-2}^{-1} &\stackrel{\text{ind.step}}{=} \\ = q^{n+2} t_r^{-1} (g_r \cdots g_{r-n-1}) + & \\ + (q-1) \sum_{j=1}^{n+1} q^{n-j+2} t_{r-j}^{-1} (g_r \cdots g_{r-j+2} g_{r-j} \cdots g_{r-n-1}) + & \\ + (q-1) t_{r-n-2}^{-1} (g_r \cdots g_{r-n}) = q^{n+2} t_r^{-1} (g_r \cdots g_{r-n-1}) + & \\ + (q-1) \sum_{j=1}^{n+2} q^{(n+1)-j+1} t_{r-j}^{-1} (g_r \cdots g_{r-j+2} g_{r-j} \cdots g_{r-n-1}). & \quad \square \end{aligned}$$

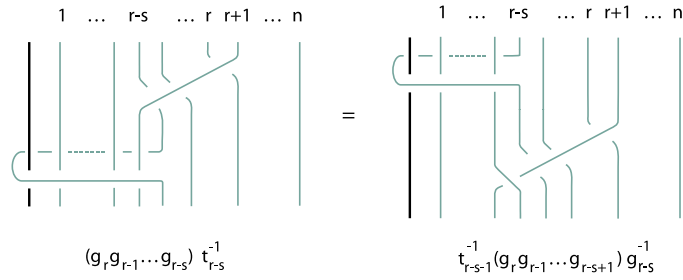

Fig. 3.4: Illustrating Lemma 5(ii) for $k = r - s$.

Before proceeding with the next lemma we introduce the notion of length of $w \in H_n(q)$. For convenience we set $\delta_{k,r} := g_k g_{k-1} \cdots g_{r+1} g_r$ for $k > r$ and by convention we set $\delta_{k,k} := g_k$.

Definition 3.5. We define the *length* of $\delta_{k,r} \in H_n(q)$ to be the number of braiding generators, that is, $l(\delta_{k,r}) := k - r + 1$ and since every element of the Iwahori-Hecke algebra of type A can be written as $\prod_{i=1}^{n-1} \delta_{k_i, r_i}$ so that $k_j < k_{j+1} \forall j$, we define the *length* of an element $w \in H_n(q)$ as:

$$l(w) := \sum_{i=1}^{n-1} l_i(\delta_{k_i, r_i}) = \sum_{i=1}^{n-1} k_i - r_i + 1.$$

Note that $l(g_k) = l(\delta_{k,k}) = k - k + 1 = 1$.

Lemma 3.6. For $k > r$ the following relations hold in $H_{1,n}(q)$:

$$t_k \delta_{k,r} = \sum_{i=0}^{k-r} q^i (q-1) \delta_{k, \overline{k-i}, r} t_{k-i} + q^{l(\delta_{k,r})} \delta_{k,r} t_{r-1},$$

where $\delta_{k, \overline{k-i}, r} := g_k g_{k-1} \cdots g_{k-i+1} g_{k-i-1} \cdots g_r := g_k \cdots \overline{g_{k-i}} \cdots g_r$.

Proof. We prove relations by induction on k . For $k = 1$ we have that $t_1 g_1 = (q-1)t_1 + qg_1 t$, which holds. Suppose that the relation holds for $(k-1)$, then for k we have:

$$\begin{aligned} t_k \delta_{k,r} &= \frac{t_k g_k}{g_k} \cdot \delta_{k-1,r} = (q-1)t_k \delta_{k-1,r} + qg_k t_{k-1} \delta_{k-1,r} = \\ &= (q-1)\delta_{k-1,r} t_k + qg_k \sum_{i=0}^{k-1-r} q^i (q-1) \delta_{k-1, \overline{k-1-i}, r} t_{k-1-i} + \\ &+ q^{l(\delta_{k-1,r})+1} g_k \delta_{k-1,r} t_{r-1} = \\ &= \sum_{i=0}^{k-r} q^i (q-1) \delta_{k, \overline{k-1-i}, r} t_{k-1-i} + q^{l(\delta_{k,r})} \delta_{k,r} t_{r-1}. \end{aligned}$$

□

Lemma 3.7. In $H_{1,n}(q)$ the following relations hold:

(i) For the expression $A = (g_r g_{r+1} \cdots g_{r+s}) \cdot t_k$ the following hold for the different values of $k \in \mathbb{N}$:

- (1) $A = t_k (g_r \cdots g_{r+s})$ for $k \geq r+s+1$ or $k < r-1$
- (2) $A = t_{k+1} (g_r \cdots g_k g_{k+1}^{-1} g_{k+2} \cdots g_{r+s})$
for $r-1 \leq k < r+s$
- (3) $A = (q-1) \sum_{i=r}^{r+s} q^{r+s-i} t_i (g_r \cdots \overline{g_i} \cdots g_{r+s}) + q^{s+1} t_{r-1} (g_r \cdots g_{r+s})$
for $k = r+s$

(ii) For the expression $A = (g_r g_{r+1} \cdots g_{r+s}) \cdot t_k^{-1}$ the following hold for the different values of $k \in \mathbb{N}$:

- (1) $A = t_k^{-1} (g_r g_{r+1} \cdots g_{r+s})$ for $k \geq r+s+1$ or $k < r-1$
- (2) $A = q t_{k+1}^{-1} (g_r \cdots g_{r+s}) + (q-1) t_{r-1}^{-1} (g_r^{-1} \cdots g_k^{-1} g_{k+2} \cdots g_{r+s})$
for $r-1 \leq k < r+s$
- (3) $A = t_{r-1}^{-1} (g_r^{-1} \cdots g_{r+s}^{-1})$ for $k = r+s$

Proof. We prove relation (i) for $r+s = k$ by induction on k (case 3). All other relations follow from Lemmas 3.1 and 3.3.

For $k = 1$ we have: $g_1 t_1 = g_1^2 t g_1 = q t g_1 + (q-1)t_1$. Suppose that the relation holds for $k = n$. Then, for $k = n+1$ we have that:

$$\begin{aligned} g_r \cdots g_{n+1} t_{n+1} &= q(g_r \cdots g_n t_n) g_{n+1} + (q-1)(g_r \cdots g_n) t_{n+1} \stackrel{\text{ind. step}}{=} \\ &= q[(q-1) \sum_{i=r}^n q^{n-i} t_i (g_r \cdots \overline{g_i} \cdots g_n) + q^{n-r+1} t_{r-1} (g_r \cdots g_n)] g_{n+1} + \\ &+ (q-1) t_{n+1} (g_r \cdots g_n) = \\ &= ((q-1) \sum_{i=r}^n q^{n-i+1} t_i (g_r \cdots \overline{g_i} \cdots g_n g_{n+1}) + (q-1) t_{n+1} (g_r \cdots g_n)) + \\ &+ q^{n+1-r+1} t_{r-1} (g_r \cdots g_n g_{n+1}) = \\ &= (q-1) \sum_{i=r}^{n+1} q^{n+1-i} t_i (g_r \cdots \overline{g_i} \cdots g_{n+1}) + q^{n+1-r+1} t_{r-1} (g_r \cdots g_{n+1}). \end{aligned}$$

□

Lemma 3.8. *The following relations hold in $H_{1,n}(q)$ for $k \in \mathbb{N}$:*

$$\begin{aligned}
(i) \quad & (g_1 \cdots g_{i-1} g_i^2 g_{i-1} \cdots g_1) \cdot t = \\
& (q-1) \sum_{k=1}^i q^{i-k} t_k (g_1 \cdots g_{k-1} g_k^{-1} g_{k-1}^{-1} \cdots g_1^{-1}) + q^i t \\
(ii) \quad & (g_1^{-1} \cdots g_{i-1}^{-1} g_i^{-2} g_{i-1}^{-1} \cdots g_1^{-1}) \cdot t^{-1} = \\
& (q^{-1} - 1) \sum_{k=1}^i q^{-(i-k)} t_k^{-1} (g_1^{-1} \cdots g_{k-1}^{-1} g_k g_{k-1} \cdots g_1) + q^{-i} t^{-1} \\
(iii) \quad & (g_k^{-1} \cdots g_2^{-1} g_1^{-2} g_2^{-1} \cdots g_k^{-1}) \cdot t_k = \\
& (q^{-1} - 1) \sum_{i=1}^{k-1} q^{-k} t_i (g_k^{-1} \cdots g_{i+2}^{-1} g_{i+1} g_{i+2} \cdots g_k) + q^{-k} t_k \\
(iv) \quad & (g_k^{-1} \cdots g_2^{-1} g_1^{-2} g_2^{-1} \cdots g_k^{-1}) \cdot t_k^{-1} = \\
& t^{-1} q^{-k} (q^{-1} - 1) g_k^{-1} \cdots g_1^{-1} \cdots g_k^{-1} + \\
& + \sum_{i=0}^{k-1} t_i^{-1} q^{-k+i} (q^{-1} - 1) g_k^{-1} \cdots g_1^{-2} \cdots g_i^{-1} g_{i+2}^{-1} \cdots g_k^{-1} + \\
& + t_k^{-1} \left[\sum_{i=2}^k q^{-k+i} (q^{-1} - 1)^2 g_{i-1}^{-1} \cdots g_2^{-1} g_1^{-2} g_2^{-1} \cdots g_{i-1}^{-1} + \right. \\
& \left. + q^{-(k+1)} (q^2 - q + 1) \right].
\end{aligned}$$

Proof. We prove relations (i) by induction on i . All other relations follow similarly. For $i = 1$ we have: $g_1^2 t = g_1 g_1 t g_1 g_1^{-1} = g_1 t_1 g_1^{-1} = (q-1) t_1 g_1^{-1} + q t$. Suppose that the relation holds for $i = n$. Then, for $i = n + 1$ we have:

$$\begin{aligned}
& (g_1 \cdots g_n g_{n+1}^2 g_n \cdots g_1) \cdot t = (q-1) (g_1 \cdots g_{n+1} g_n \cdots g_1) \cdot t + \\
& + q (g_1 \cdots g_{n-1} g_n^2 g_{n-1} \cdots g_1) \cdot t = \\
& = (q-1) g_1 \cdots g_n t_{n+1} g_{n+1}^{-1} \cdots g_1^{-1} + q \sum_{k=1}^n q^{n-k} (q-1) t_k \cdot \\
& (g_1 \cdots g_{k-1} g_k^{-1} \cdots g_1^{-1}) + q^{n+1} t = \\
& = (q-1) t_{n+1} (g_1 \cdots g_n g_{n+1}^{-1} \cdots g_1^{-1}) + \sum_{k=1}^n q^{n+1-k} (q-1) t_k \cdot \\
& (g_1 \cdots g_{k-1} g_k^{-1} \cdots g_1^{-1}) + q^{n+1} t = \\
& = \sum_{k=1}^{n+1} q^{n+1-k} (q-1) t_k (g_1 \cdots g_{k-1} g_k^{-1} \cdots g_1^{-1}) + q^{n+1} t. \quad \square
\end{aligned}$$

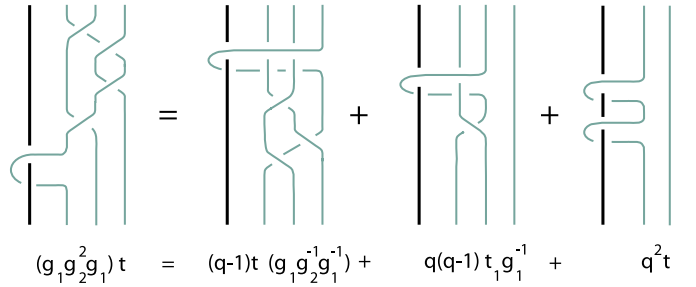

Fig. 3.5: Illustrating Lemma 8(i) for $i = 2$.

3.3.2 Converting elements in Λ' to elements in Σ_n

We are now in the position to prove a set of relations converting monomials of t'_i 's to expressions containing the t_i 's. In the appendix we provide lemmas converting monomials of t_i 's to monomials of t'_i 's in the context of giving a simple proof that the sets Σ'_n form bases of $H_{1,n}(q)$.

Lemma 3.9. *The following relations hold in $H_{1,n}(q)$ for $k \in \mathbb{N}$:*

$$\begin{aligned} (i) \quad t_1'^{-k} &= q^k t_1^{-k} + \sum_{j=1}^k q^{k-j} (q-1) t^{-j} t_1^{j-k} \cdot g_1^{-1}, \\ (ii) \quad t_1^k &= q^{-k} t_1^k + \sum_{j=1}^k q^{-(k-j)} (q^{-1}-1) t^{j-1} t_1^{k+1-j} \cdot g_1^{-1}. \end{aligned}$$

Proof. We prove relations (i) by induction on k . Relations (ii) follow similarly. For $k=1$ we have: $t_1'^{-1} = \underline{g_1} t^{-1} g_1^{-1} = q \underline{g_1^{-1} t^{-1} g_1^{-1}} + (q-1) t^{-1} g_1^{-1} = q t_1^{-1} + (q-1) t^{-1} g_1^{-1}$. Suppose that the relation holds for $k-1$. Then, for k we have:

$$\begin{aligned} t_1'^{-k} &= t_1'^{-(k-1)} t_1'^{-1} \stackrel{\text{ind. step}}{=} q^{k-1} t_1^{-(k-1)} t_1'^{-1} + \\ &+ \sum_{j=1}^{k-1} q^{k-1-j} (q-1) t^{-j} t_1^{j-(k-1)} g_1^{-1} t_1'^{-1} = \\ &= q^k t_1^{-k} + q^{k-1} t^{-1} t_1^{-(k-1)} g_1^{-1} + \sum_{j=1}^{k-1} q^{k-1-j} (q-1) t^{-j} t_1^{j-(k-1)} t^{-1} g_1^{-1} \\ &= q^k t_1^{-k} + q^{k-1} (q-1) t^{-1} t_1^{-(k-1)} g_1^{-1} + \\ &+ \sum_{j=1}^{k-1} q^{k-1-j} (q-1) t^{-j-1} t_1^{j-(k-1)} g_1^{-1} = \\ &= q^k t_1^{-k} + \sum_{j=1}^k q^{k-j} (q-1) t^{-j} t_1^{j-k} g_1^{-1}. \end{aligned}$$

□

Lemma 3.10. *The following relations hold in $H_{1,n}(q)$ for $k \in \mathbb{N}$:*

$$t_k'^{-1} = q^k t_k^{-1} + (q-1) \sum_{i=0}^{k-1} q^i t_i^{-1} (g_k g_{k-1} \cdots g_{i+2} g_{i+1}^{-1} \cdots g_{k-1}^{-1} g_k^{-1}).$$

Proof. We prove the relations by induction on k . For $k=1$ we have:

$$t_1'^{-1} = \underline{g_1} t^{-1} g_1^{-1} = q \underline{g_1^{-1} t^{-1} g_1^{-1}} + (q-1) t^{-1} g_1^{-1} = q t_1^{-1} + (q-1) t^{-1} g_1^{-1}.$$

Suppose that the relations hold for $k=n$. Then, for $k=n+1$ we have that:

$$\begin{aligned} t_{n+1}'^{-1} &= g_{n+1} \underline{t_n'^{-1}} g_{n+1}^{-1} \stackrel{\text{ind. step}}{=} \\ &= g_{n+1} [q^n t_n^{-1} + (q-1) \sum_{i=0}^{n-1} q^i t_i^{-1} (g_n \cdots g_{i+2} g_{i+1}^{-1} \cdots g_n^{-1})] g_{n+1}^{-1} = \\ &= q^n \underline{g_{n+1} t_n^{-1}} g_{n+1}^{-1} + (q-1) \sum_{i=0}^{n-1} q^i \underline{g_{n+1} t_i^{-1}} (g_n \cdots g_{i+2} g_{i+1}^{-1} \cdots g_n^{-1} g_{n+1}^{-1}) = \\ &= q^n [q t_{n+1}^{-1} g_{n+1} + (q-1) t_n^{-1}] g_{n+1}^{-1} + (q-1) \sum_{i=0}^{n-1} q^i t_i^{-1} \cdot \\ &\quad (g_{n+1} \cdots g_{i+2} g_{i+1}^{-1} \cdots g_{n+1}^{-1}) = \\ &= q^{n+1} t_{n+1}^{-1} + q^n (q-1) t_n^{-1} g_{n+1}^{-1} + (q-1) \sum_{i=0}^{n-1} q^i t_i^{-1} \cdot \\ &\quad (g_{n+1} \cdots g_{i+2} g_{i+1}^{-1} \cdots g_{n+1}^{-1}) = \\ &= q^{n+1} t_{n+1}^{-1} + (q-1) \sum_{i=0}^n q^i t_i^{-1} (g_{n+1} \cdots g_{i+2} g_{i+1}^{-1} \cdots g_{n+1}^{-1}). \end{aligned}$$

□

Lemma 3.11. *The following relations hold in $H_{1,n}(q)$ for $k \in \mathbb{Z} \setminus \{0\}$:*

$$t_m'^k = q^{-mk} t_m^k + \sum_i f_i(q) t_m^k w_i + \sum_i g_i(q) t^{\lambda_0} t_1^{\lambda_1} \dots t_m^{\lambda_m} u_i,$$

where $w_i, u_i \in H_{m+1}(q)$, $\forall i$, $\sum_{i=0}^m \lambda_i = k$ and $\lambda_i \geq 0$, $\forall i$, if $k > 0$ and $\lambda_i \leq 0$, $\forall i$, if $k < 0$.

Proof. We prove relations by induction on m . The case $m = 1$ is Lemma 3.9. Suppose now that the relations hold for $m - 1$. Then, for m we have:

$$\begin{aligned} t_m'^k &= g_m t_{m-1}'^k g_m^{-1} \stackrel{\text{ind. step}}{=} q^{-(m-1)k} g_m t_{m-1}^k g_m^{-1} + \sum_i f_i(q) g_m t_{m-1}^k w_i g_m^{-1} + \\ &+ \sum_i g_i(q) t^{\lambda_0} t_1^{\lambda_1} \dots t_{m-2}^{\lambda_{m-2}} g_m t_{m-1}^{\lambda_{m-1}} u_i g_m^{-1} \stackrel{(L.4)}{=} \\ &= q^{-(m-1)k} q^{-(k-1)} t_m^k g_m^{-2} + \sum_{j=1}^{k-1} q^{-(k-1-j)} (q^{-1} - 1) t_{m-1}^j t_m^{k-j} g_m^{-1} = \\ &= q^{-mk} t_m^k + \sum_i f_i(q) t_m^k w_i + \sum_i g_i(q) t^{\lambda_0} t_1^{\lambda_1} \dots t_m^{\lambda_m} u_i. \quad \square \end{aligned}$$

Using now Lemma 3.11 we have that every element $u \in \Lambda'$ can be expressed to linear combinations of elements $v_i \in \Sigma_n$, where $\exists j : v_j \sim u$. More precisely:

Theorem 3.3. *The following relations hold in $H_{1,n}(q)$ for $k \in \mathbb{Z}$:*

$$t^{k_0} t_1^{k_1} \dots t_m^{k_m} = q^{-\sum_{n=1}^m n k_n} \cdot t^{k_0} t_1^{k_1} \dots t_m^{k_m} + \sum_i f_i(q) \cdot t^{k_0} t_1^{k_1} \dots t_m^{k_m} \cdot w_i + \sum_j g_j(q) \tau_j \cdot u_j,$$

where $w_i, u_j \in H_{m+1}(q)$, $\forall i$, $\tau_j \in \Sigma_n$, such that $\tau_j < t^{k_0} t_1^{k_1} \dots t_m^{k_m}$, $\forall j$.

Proof. We prove relations by induction on m . Let $k_1 \in \mathbb{N}$, then for $m = 1$ we have:

$$\begin{aligned} t^{k_0} t_1^{k_1} &\stackrel{(L.9)}{=} q^{-k_1} t^{k_0} t_1^{k_1} + \sum_{j=1}^{k_1} q^{-(k_1-j)} (q^{-1} - 1) t^{k_0+j-1} t_1^{k_1+1-j} g_1^{-1} = \\ &= q^{-k_1} t^{k_0} t_1^{k_1} + q^{-k_1} (q^{-1} - 1) t^{k_0} t_1^{k_1} g_1^{-1} + \\ &+ \sum_{j=2}^{k_1} q^{-(k_1-j)} (q^{-1} - 1) t^{k_0+j-1} t_1^{k_1+1-j} g_1^{-1}. \end{aligned}$$

On the right hand side we obtain a term which is the homologous word of $t^{k_0} t_1^{k_1}$ with scalar $q^{-k_1} \in \mathbb{C}$, the homologous word again followed by $g_1^{-2} \in H_2(q)$ and with scalar $q^{-(k_1-1)} (q^{-1} - 1) \in \mathbb{C}$ and the terms $t^{k_0+j-1} t_1^{k_1+1-j}$, which are of less order than the homologous word $t^{k_0} t_1^{k_1}$, since $k_1 > k_1 + 1 - j$, for all $j \in \{2, 3, \dots, k_1\}$. So the statement holds for $m = 1$ and $k_1 \in \mathbb{N}$. The case $m = 1$ and $k_1 \in \mathbb{Z} \setminus \mathbb{N}$ is similar.

Suppose now that the relations hold for $m - 1$. Then, for m we have:

$$\begin{aligned} t^{k_0} t_1^{k_1} \dots t_m^{k_m} &\stackrel{\text{ind. step}}{=} q^{-\sum_{n=1}^{m-1} n k_n} \cdot t^{k_0} \dots t_{m-1}^{k_{m-1}} \cdot t_m^{k_m} + \\ &+ \sum_i f_i(q) \cdot t^{k_0} t_1^{k_1} \dots t_{m-1}^{k_{m-1}} \cdot w_i \cdot t_m^{k_m} \\ &+ \sum_j g_j(q) \tau_j \cdot u_j \cdot t_m^{k_m}. \end{aligned}$$

Now, since $w_i, u_i \in H_m(q)$, $\forall i$ we have that $w_i t_m^{k_m} = t_m^{k_m} w_i$ and $u_i t_m^{k_m} = t_m^{k_m} u_i$, $\forall i$. Applying now Lemma 3.11 to $t_m'^k$ we obtain the requested relation. \square

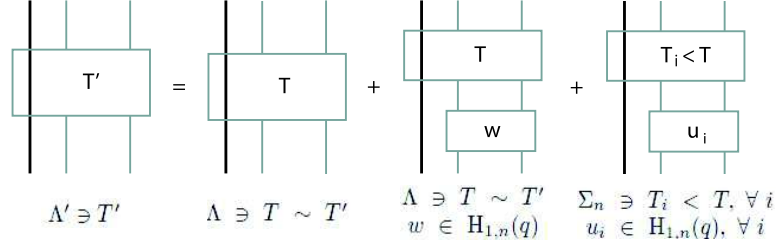

Fig. 3.6: Illustrating Theorem 3.3.

Example 3.1. We convert the monomial $tt'_1t'_2{}^{-2} \in \Lambda'$ to linear combination of elements in Σ_n . We have that:

$$\begin{aligned}
t'_1 &= q^{-1}t_1 + (q^{-1} - 1)t_1g_1^{-1}, \text{ (Lemma 3.9),} \\
t'_2{}^{-2} &= q^4t_2{}^{-2} + q^3(q-1)t_1^{-1}t_2^{-1}g_2^{-1} + q^2(q-1)t^{-1}t_2^{-1}g_2g_1^{-1}g_2^{-1} + \\
&+ q^2(q-1)t_1^{-2}g_2^{-1} + q(q-1)^2t^{-1}t_1^{-1}g_1^{-1}g_2^{-1} + (q-1)t^{-2}g_2g_1^{-1}g_2^{-1}, \\
&\text{(Lemma 3.10),}
\end{aligned}$$

and so:

$$\begin{aligned}
tt'_1t'_2{}^{-2} &= q^3 \cdot tt_1t_2{}^{-2} + q^4(q^{-1} - 1) \cdot tt_1t_2{}^{-2} \cdot g_1^{-1} + 1 \cdot u + \\
&+ tt_1^{-1} \cdot ((q-1)(q^2 - q + 1) \cdot g_2^{-1} - (q-1)^2 \cdot g_1g_2g_1^{-1}g_2^{-1}) + \\
&+ tt_2^{-1} \cdot (q^2(q-1) \cdot g_2^{-1} + q(q-1)^3 \cdot g_2^{-1} - q(q-1)^2 \cdot g_2g_1^{-1}g_2^{-1}) + \\
&+ t_1t_2^{-1} \cdot (q(q-1) \cdot g_2g_1^{-1}g_2^{-1} - q(q-1)^2 \cdot g_1^{-1}g_2^{-1}) + \\
&+ t^{-1}t_1 \cdot (-(q-1) \cdot g_2g_1^{-1}g_2^{-1} - q^{-1}(q-1)^2 \cdot g_1^{-1}g_2^{-1})
\end{aligned}$$

where $u = (q-1)^2g_1^{-1}g_2^{-1} - (q-1)^3g_1^{-2}g_2^{-1} - q^{-1}(q-1)^3g_2g_1^{-1}g_2^{-1} + q^{-1}(q-1)^3g_2^{-1}$.

We obtain the homologous word $w = tt_1t_2{}^{-2}$, the homologous word again followed by the braiding generator g_1^{-1} and terms in Σ_n of less order than w , since either their index is less than $ind(w)$ (the terms tt_1^{-1} , 1 and $t^{-1}t_1$), either they contain gaps in the indices (the terms tt_2^{-1} and $t_1t_2^{-1}$).

3.4 From Σ_n to Λ

In order to prove Theorem 3.2 we need to show that the set Λ is a spanning set of $\mathcal{S}(\text{ST})$ and also that is linear independent. In this section we show that every element in Λ' can be expressed in terms of elements in the set Λ . Linear independence of the set Λ is shown in the next section.

Before proceeding we need to discuss the following situation. According to Lemma 3.9, for a word $w' = t^k t_1'^{-\lambda} \in \Lambda'$, where $k, \lambda \in \mathbb{N}$ and $k < \lambda$ we have that:

$$\begin{aligned}
w' = t^k t_1'^{-\lambda} &= t^{k-1}t_1^{-\lambda+1}\alpha_1 + t^{k-2}t_1^{-\lambda+2}\alpha_2 + \dots + \\
&+ t^0t_1^{-\lambda+k}\alpha_k + t^{-1}t_1^{-\lambda+k+1}\alpha_{k+1} + \dots + t^{-\lambda+k}\alpha_\lambda,
\end{aligned}$$

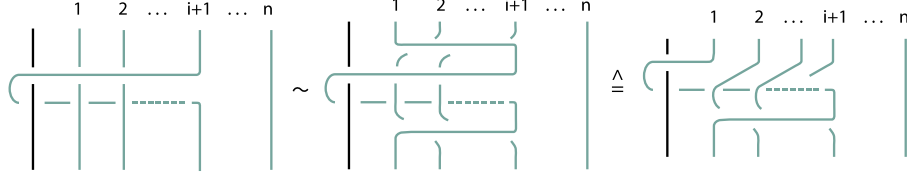

Fig. 3.7: Conjugating t_i by $g_1^{-1} \dots g_i^{-1}$.

where $\alpha_i \in H_n(q)$, $\forall i$. We observe that in this particular case, in the right hand side there are terms which do not belong to the set Λ . These are the terms of the form $t^q t_1^p$, where $p > q$ and the term t_1^m . So these elements cannot be compared with the highest order term $w \sim w'$. The point now is that these terms are elements in the basis Σ_n on the Hecke algebra level, but, when we are working in $\mathcal{S}(\text{ST})$, such elements must be considered up to conjugation by any braiding generator and up to stabilization moves. Topologically, conjugation corresponds to closing the braiding part of a mixed braid. Conjugating t_1 by g_1^{-1} we obtain tg_1^2 (view Figure 3.7) and similarly conjugating t_1^m by g_1^{-1} we obtain $tg_1^2 t_1^2 \dots tg_1^2$. Then, applying Lemma 3.3 we obtain the expression $\sum_{k=1}^{m-1} t^k t_1^{m-k} v_k$, where $v_k \in H_n(q)$, for all k , that is, we obtain now elements with consecutive indices but not necessarily with ordered exponents.

We shall first deal with elements where the looping generators do not have consecutive indices, and then with elements where the exponents are not in decreasing order. For the expressions that we obtain after appropriate conjugations we shall use the notation $\hat{=}$.

3.4.1 Managing the gaps

We will call *gaps* in monomials of the t_i 's, gaps occurring in the indices and *size* of the gap $t_i^{k_i} t_j^{k_j}$ the number $s_{i,j} = j - i \in \mathbb{N}$.

Lemma 3.12. *For $k_0, k_1 \dots k_i \in \mathbb{Z}$, $\epsilon = 1$ or $\epsilon = -1$ and $s_{i,j} > 1$ the following relation holds in $H_{1,n}(q)$:*

$$t^{k_0} t_1^{k_1} \dots t_{i-1}^{k_{i-1}} t_i^{k_i} \cdot t_j^\epsilon \hat{=} t^{k_0} t_1^{k_1} \dots t_{i-1}^{k_{i-1}} t_i^{k_i} \cdot t_{i+1}^\epsilon (g_{i+2}^\epsilon \dots g_{j-1}^\epsilon g_j^{2\epsilon} g_{j-1}^\epsilon \dots g_{i+2}^\epsilon).$$

Proof. We have that $t_j^\epsilon = (g_j^\epsilon \dots g_{i+2}^\epsilon) t_{i+1}^\epsilon (g_{i+2}^\epsilon \dots g_j^\epsilon)$ and so:

$$\begin{aligned} t^{k_0} t_1^{k_1} \dots t_{i-1}^{k_{i-1}} t_i^{k_i} t_j^\epsilon &= t^{k_0} t_1^{k_1} \dots t_{i-1}^{k_{i-1}} t_i^{k_i} (g_j^\epsilon \dots g_{i+2}^\epsilon) t_{i+1}^\epsilon (g_{i+2}^\epsilon \dots g_j^\epsilon) = \\ &= (g_j^\epsilon \dots g_{i+2}^\epsilon) t^{k_0} t_1^{k_1} \dots t_{i-1}^{k_{i-1}} t_i^{k_i} t_{i+1}^\epsilon (g_{i+2}^\epsilon \dots g_j^\epsilon) \hat{=} \\ &\hat{=} t^{k_0} \dots t_{i-1}^{k_{i-1}} t_i^{k_i} t_{i+1}^\epsilon (g_{i+2}^\epsilon \dots g_{j-1}^\epsilon g_j^{2\epsilon} g_{j-1}^\epsilon \dots g_{i+2}^\epsilon). \end{aligned}$$

□

In order to pass to a general way for managing gaps in monomials of t_i 's we first deal with gaps of size one. For this we have the following.

Lemma 3.13. For $k \in \mathbb{N}$, $\epsilon = 1$ or $\epsilon = -1$ and $\alpha \in H_{1,n}(q)$ the following relations hold:

$$t_i^{\epsilon k} \cdot \alpha \hat{=} \sum_{u=1}^{k-1} q^{\epsilon(u-1)} (q^\epsilon - 1) t_{i-1}^{\epsilon u} t_i^{\epsilon(k-u)} (\alpha g_i^\epsilon) + q^{\epsilon(k-1)} t_{i-1}^{\epsilon k} (g_i^\epsilon \alpha g_i^\epsilon).$$

Proof. We prove the relations by induction on k . For $k = 1$ we have $t_i^\epsilon \cdot \alpha \hat{=} g_i^\epsilon t_{i-1}^\epsilon g_i^\epsilon \cdot \alpha \hat{=} t_{i-1}^\epsilon g_i^\epsilon \cdot \alpha \cdot g_i^\epsilon$. Suppose that the assumption holds for $k-1 > 1$. Then for k we have:

$$\begin{aligned} t_i^{\epsilon k} \cdot \alpha &\hat{=} t_i^{\epsilon(k-1)} (t_i^\epsilon \cdot \alpha) \stackrel{(t_i^\epsilon \cdot \alpha = \beta)}{=} t_i^{\epsilon(k-1)} \cdot \beta \stackrel{\text{ind. step}}{\hat{=}} \\ &= \sum_{u=1}^{k-2} q^{\epsilon(u-1)} (q^\epsilon - 1) t_{i-1}^{\epsilon u} t_i^{\epsilon(k-1-u)} (\beta g_i^\epsilon) + q^{\epsilon(k-2)} t_{i-1}^{\epsilon(k-1)} (g_i^\epsilon \beta g_i^\epsilon) \stackrel{(\beta = t_i^\epsilon \cdot \alpha)}{=} \\ &= \sum_{u=1}^{k-2} q^{\epsilon(u-1)} (q^\epsilon - 1) t_{i-1}^{\epsilon u} t_i^{\epsilon(k-1-u)} t_i^\epsilon (\alpha g_i^\epsilon) + q^{\epsilon(k-2)} t_{i-1}^{\epsilon(k-1)} (g_i^\epsilon t_i^\epsilon \alpha g_i^\epsilon) = \\ &= \sum_{u=1}^{k-2} q^{\epsilon(u-1)} (q^\epsilon - 1) t_{i-1}^{\epsilon u} t_i^{\epsilon(k-u)} (\alpha g_i^\epsilon) + q^{\epsilon(k-2)} t_{i-1}^{\epsilon(k-1)} t_i^\epsilon \alpha g_i^\epsilon + \\ &+ q^{\epsilon(k-1)} t_{i-1}^{\epsilon(k-1+1)} (g_i^\epsilon t_i^\epsilon \alpha g_i^\epsilon) = \\ &= \sum_{u=1}^{k-1} q^{\epsilon(u-1)} (q^\epsilon - 1) t_{i-1}^{\epsilon u} t_i^{\epsilon(k-u)} (\alpha g_i^\epsilon) + q^{\epsilon(k-1)} t_{i-1}^{\epsilon k} (g_i^\epsilon \alpha g_i^\epsilon). \quad \square \end{aligned}$$

We now introduce the following notation.

Notation 3.1. We set $\tau_{i,i+m}^{k_i,i+m} := t_i^{k_i} t_{i+1}^{k_{i+1}} \dots t_{i+m}^{k_{i+m}}$, where $m \in \mathbb{N}$ and $k_j \neq 0$ for all j and

$$\delta_{i,j} := \begin{cases} g_i g_{i+1} \dots g_{j-1} g_j & \text{if } i < j \\ g_i g_{i-1} \dots g_{j+1} g_j & \text{if } i > j \end{cases}, \quad \delta_{i,\widehat{k},j} := \begin{cases} g_i g_{i+1} \dots g_{k-1} g_{k+1} \dots g_{j-1} g_j & \text{if } i < j \\ g_i g_{i-1} \dots g_{k+1} g_{k-1} \dots g_{j+1} g_j & \text{if } i > j \end{cases}$$

We also set $w_{i,j}$ an element in $H_{j+1}(q)$ where the minimum index in w is i .

Using now the notation introduced above, we apply Lemma 3.13 $s_{i,j}$ -times to 1-gap monomials of the form $\tau_{0,i}^{k_{0,i}} \cdot t_j^{k_j}$ and we obtain monomials with no gaps in the indices, followed by words in $H_n(q)$.

Example 3.2. For $s_{i,j} > 1$ and $\alpha \in H_n(q)$ we have:

$$\begin{aligned} (i) \quad &\tau_{0,i}^{k_i} \cdot t_j \cdot \alpha \hat{=} \tau_{0,i}^{k_i} \cdot t_{i+1} \cdot \delta_{i+2,j} \alpha \delta_{j,i+2} \\ (ii) \quad &\tau_{0,i}^{k_i} \cdot t_j^2 \cdot \alpha \hat{=} \tau_{0,i}^{k_i} \cdot t_{i+1}^2 \cdot \delta_{i+2,j} \alpha \delta_{j,i+2} + \tau_{0,i}^{k_i} \cdot t_{i+1} t_{i+2} \cdot \beta, \text{ where} \\ &\beta = \left[(q-1) \sum_{s=i+2}^j q^{j-s} \delta_{i+3,s} \delta_{i+2,s-1} \delta_{s+1,j} \alpha \delta_{j,i+2} \delta_{s,i+3} \right] \\ (iii) \quad &\tau_{0,i}^{k_i} \cdot t_j^3 \cdot \alpha \hat{=} \left[q^{j-(i+2)+1} \right]^2 \tau_{0,i}^{k_i} \cdot t_{i+1}^3 \cdot \delta_{i+2,j} \alpha \delta_{j,i+2} + \\ &+ \tau_{0,i}^{k_i} \cdot t_{i+1}^2 t_{i+2} \cdot \beta + \tau_{0,i}^{k_i} \cdot t_{i+1} t_{i+2}^2 \cdot \gamma + \\ &+ \tau_{0,i}^{k_i} \cdot t_{i+1} t_{i+2} t_{i+3} \cdot \mu, \text{ where} \\ &\gamma = q^{j-(i+3)+1} (q-1) \delta_{i+3,j} \delta_{i+2,s-1} \delta_{s+1,j} \alpha \delta_{j,i+2} \delta_{s,i+3}, \text{ and} \\ &\mu = \sum_{s=i+2}^j \sum_{r=s+1}^j q^{2j-r-s} (q-1)^2 \delta_{i+4,r} \delta_{i+2,s-1} \delta_{s+1,r-1} \delta_{r+1,j} \cdot \\ &\alpha \delta_{j,i+2} \delta_{s,i+3} \delta_{r,i+4} + \sum_{s=i+2}^j \sum_{r=i+3}^s q^{2j-r-s} (q-1)^2 \cdot \\ &\delta_{i+4,r} \delta_{i+3,r-1} \delta_{r+1,s} \delta_{i+2,s-1} \delta_{s+1,j} \alpha \delta_{j,i+2} \delta_{s,i+3}. \end{aligned}$$

Applying Lemma 3.13 to the one gap word $\tau_{0,i}^{k_0,i} \cdot t_j^{k_j}$, where $k_j \in \mathbb{Z} \setminus \{0\}$ and $\alpha \in H_n(q)$ we obtain:

$$\tau_{0,i}^{k_0,i} \cdot t_j^{k_j} \alpha \hat{=} \begin{cases} \sum_{\lambda} \tau_{0,i}^{k_0,i} t_{i+1}^{\lambda_{i+1}} \cdots t_{i+k_j}^{\lambda_{i+k_j}} \alpha' & \text{if } k_j < s_{i,j} \\ \sum_{\lambda} \tau_{0,i}^{k_0,i} t_{i+1}^{\lambda_{i+1}} \cdots t_j^{\lambda_j} \beta' & \text{if } k_j \geq s_{i,j} \end{cases},$$

where $\alpha', \beta' \in H_n(q)$, $\sum_{\mu=i+1}^{i+k_j} \lambda_{\mu} = k_j$, $\lambda_{\mu} \geq 0$, $\forall \mu$ and if $\lambda_u = 0$, then $\lambda_v = 0$, $\forall v \geq u$.

More precisely:

Lemma 3.14. *For the 1-gap word $A = \tau_{0,i}^{k_0,i} \cdot t_j^{k_j} \cdot \alpha$, where $\alpha \in H_n(q)$ we have:*

- (i) If $|k_j| < s_{i,j}$, then : $A \hat{=} (q^{k_j-1})^{j-(i+1)} \tau_{0,i}^{k_0,i} \cdot t_{i+1}^{k_j} \delta_{i+2,j} \alpha \delta_{j,i+2} + \sum_{k_j} f(q) \tau_{0,i}^{k_0,i} \tau_{i+1,i+k_j}^{k_{i+1,i+k_j}} \cdot \beta \alpha \beta'$.
- (ii) If $|k_j| \geq s_{i,j}$, then : $A \hat{=} (q^{k_j-1})^{j-(i+1)} \tau_{0,i}^{k_0,i} \cdot t_{i+1}^{k_j} \delta_{i+2,j} \alpha \delta_{j,i+2} + \sum_{k_j} f(q) \tau_{0,i}^{k_0,i} \cdot \tau_{i+1,j}^{k_{i+1,j}} \cdot \beta \alpha \beta'$.

where β and β' are of the form $w_{i+1,j} \in H_{j+1}(q)$, $\sum_{k_j} f(q, z) \tau_{0,i}^{k_0,i} \tau_{i+1,i+k_j}^{k_{i+1,i+k_j}}$ means a sum of elements in Σ_n , such that in each one them, the sum of the exponents of the looping generators $t_{i+1}, \dots, t_{i+k_j}$ is equal to k_j , and such that $|k_{i+1}| < |k_j|$. Moreover, if $k_{\mu} = 0$, for some index μ , then $k_s = 0$ for all $s > \mu$.

Proof. We prove the relations by induction on k_j . Let $0 < k_j < j - i$.

For $k_j = 1$ we have $A \hat{=} [q^{(1-1)}]^{j-(i+1)} \tau_{0,i}^{k_0,i} \cdot t_{i+1} \delta_{i+2,j} \alpha \delta_{j,i+2}$ (Lemma 3.12). Suppose that the relation holds for $k_j - 1 > 1$. Then for k_j we have:

$$\begin{aligned} A &= \tau_{0,i}^{k_0,i} \cdot t_j^{k_j-1} \cdot (t_j \alpha) \underset{\text{ind.step}}{\hat{=}} \underbrace{[q^{k_j-2}]^{j-(i+1)} \tau_{0,i}^{k_0,i} \cdot t_{i+1}^{k_j-1} \delta_{i+2,j} t_j \alpha \delta_{j,i+2}}_B + \\ &\quad + \underbrace{\sum_{k_{i+1,i+k_j-1}} f(q) \tau_{0,i}^{k_0,i} \cdot \tau_{i+1,i+k_j-1}^{k_{i+1,i+k_j-1}} \beta t_j \beta'}_C. \end{aligned}$$

We now consider B and C separately and apply Lemma 3.4 to both expressions:

$$\begin{aligned} B &\stackrel{(L. 3.4)}{=} [q^{k_j-2}]^{j-(i+1)} \tau_{0,i}^{k_0,i} \cdot t_{i+1}^{k_j-1} \cdot \\ &\quad \left[(q-1) \sum_{k=i+2}^j q^{j-k} t_k \delta_{i+2,k-1} \delta_{k+1,j} + q^{j-(i+2)+1} t_{i+1} \delta_{i+2,j} \right] \alpha \delta_{j,i+2} \\ &= [q^{k_j-2}]^{j-(i+1)} (q-1) \tau_{0,i}^{k_0,i} t_{i+1} \cdot \sum_{k=i+2}^j q^{j-k} t_k \delta_{i+2,k-1} \delta_{k+1,j} \alpha \delta_{j,i+2} + \\ &\quad + [q^{k_j-1}]^{j-(i+1)} \tau_{0,i}^{k_0,i} \cdot t_{i+1}^{k_j} \delta_{i+2,j} \alpha \delta_{j,i+2}. \end{aligned}$$

We now do conjugation on the $(j - (i + 3))$ -one gap words that occur and since $t_k \cdot$

$\beta \hat{=} t_{i+2} \cdot \delta_{i+3,k} \beta \delta_{k,i+3}$ we obtain:

$$\begin{aligned} B &\hat{=} [q^{k_j-1}]^{j-(i+1)} \tau_{0,i}^{k_{0,i}} \cdot t_{i+1}^{k_j} \delta_{i+2,j} \alpha \delta_{j,i+2} + \\ &+ \tau_{0,i}^{k_{0,i}} t_{i+1} t_{i+2} \sum_{k=i+2}^j f(q, z) \delta_{i+3,k} \delta_{i+2,k-1} \delta_{k+1,j} \alpha \delta_{j,i+2} \delta_{k,i+3} = \\ &= [q^{k_j-1}]^{j-(i+1)} \tau_{0,i}^{k_{0,i}} \cdot t_{i+1}^{k_j} \delta_{i+2,j} \alpha \delta_{j,i+2} + \tau_{0,i}^{k_i} t_{i+1} t_{i+2} \cdot \beta_1, \end{aligned}$$

where $\beta_1 \in H_{j+1}(q)$.

Moreover, $C = \sum_{k_r} f(q) \tau_{0,i}^{k_{0,i}} \cdot \tau_{i+1,i+k_j-1}^{k_{i+1,i+k_j-1}} \beta t_j \beta'$ and since $\beta = w_{i+k_j-1,j}$, we have that: $\beta \cdot t_j \stackrel{(L. 3.4)}{=} \sum_{s=i+k_j-1}^j t_s \cdot \gamma_s$, where $\gamma_s \in H_{j+1}(q)$ and so: $C \hat{=} \sum_{v_r} f(q) \tau_{0,i}^{k_{0,i}} \cdot \tau_{i+1,i+k_j}^{v_{i+1,i+k_j}} \cdot \beta_2$, where $\beta_2 \in H_{j+1}(q)$.

This concludes the proof. \square

We now pass to the general case of one-gap words.

Proposition 3.3. *For the 1-gap word $B = \tau_{0,i}^{k_{0,i}} \cdot \tau_{j,j+m}^{k_{j,j+m}} \cdot \alpha$, where $\alpha \in H_n(q)$ we have:*

$$\begin{aligned} B &\hat{=} \prod_{s=0}^m (q^{k_{j+s}-1})^{j-(i+1)} \cdot \tau_{0,i}^{k_{0,i}} \tau_{i+1,i+m}^{k_{i+1,i+m}} \\ &\cdot \prod_{s=0}^m (\delta_{i+m+2-s,j+s}) \cdot \alpha \cdot \prod_{s=0}^m (\delta_{j+s,i+m+2-s}) + \\ &+ \sum_{u_r} f(q) \tau_{0,i}^{k_{0,i}} \cdot (\tau_{i+1,i+m}^{u_{1,m}}) \cdot \alpha' \end{aligned}$$

where $\alpha' \in H_n(q)$, $\sum u_{1,m} = k_j$ such that $u_1 < k_j$ and if $u_\mu = 0$, then $u_s = 0, \forall s > \mu$.

Proof. The proof follows from Lemma 4.3. The idea is to apply Lemma 4.3 on the expression $\tau_{0,i}^{k_{0,i}} \cdot t_j^{k_j} \cdot \rho_1$, where $\rho_1 = \tau_{j+1,j+m}^{k_{j+1,j+m}}$ and obtain the terms $\tau_{0,i}^{k_{0,i}} \cdot t_{i+1}^{k_j} \cdot \rho_2$ and $\tau_{0,i}^{k_{0,i}} \cdot \tau_{i+1,i+q}^{k_{i+1,i+q}} \cdot \rho_2$ and follow the same procedure until there is no gap in the word. \square

We are now ready to deal with the general case, that is, words with more than one gap in the indices of the generators.

Theorem 3.4. *For the ϕ -gap word:*

$C = \tau_{0,i}^{k_{0,i}} \cdot \tau_{i+s_1,i+s_1+\mu_1}^{k_{i+s_1,i+s_1+\mu_1}} \cdot \tau_{i+s_2,i+s_2+\mu_2}^{k_{i+s_2,i+s_2+\mu_2}} \cdots \tau_{i+s_\phi,i+s_\phi+\mu_\phi}^{k_{i+s_\phi,i+s_\phi+\mu_\phi}} \cdot \alpha$, where $k_i \in \mathbb{Z} \setminus \{0\}$ for all i , $\alpha \in H_n(q)$, $s_j, \mu_j \in \mathbb{N}$, such that $s_1 > 1$ and $s_j > s_{j-1} + \mu_{j-1}$ for all j we have:

$$\begin{aligned} C &\hat{=} \prod_{j=1}^{\phi} \left(q^{k_{i+s_j}-1} \right)^{s_j-j-\sum_{p=1}^{j-1} \mu_p} \cdot \tau_{0,i+\phi+\sum_{p=1}^{\phi} \mu_p}^{u_{0,i+\phi+\sum_{p=1}^{\phi} \mu_p}} \cdot \left(\prod_{p=0}^{\phi-1} \alpha_{\phi-p} \right) \cdot \alpha \\ &\left(\prod_{p=1}^{\phi} \alpha'_p \right) + \sum_v f_v(q) \tau_{0,v}^{k_{0,v}} \cdot w_v, \text{ where} \end{aligned}$$

$$(i) \alpha_j = \prod_{\lambda_j=0}^{\mu_j} \delta_{i+j+1+\sum_{k=1}^j \mu_k - \lambda_j, i+s_j+\mu_j-\lambda_j}, \quad j = \{1, 2, \dots, \phi\},$$

$$(ii) \alpha'_j = \prod_{\lambda_j=0}^{\mu_j} \delta_{i+j+1+\sum_{k=1}^{j-1} \mu_k + \lambda_j, i+s_j+\lambda_j}, \quad j = \{1, 2, \dots, \phi\},$$

$$(iii) \tau_{0,i+\phi+\sum_{p=1}^{\phi} \mu_p}^{u_{0,i+\phi+\sum_{p=1}^{\phi} \mu_p}} = \tau_{0,i}^{k_{0,i}} \cdot \prod_{j=1}^{\phi} \tau_{i+j+\sum_{p=1}^{j-1} \mu_p, i+j+\sum_{p=1}^j \mu_p}^{k_{i+s_j, i+s_j+\mu_j}}$$

$$(iv) \tau_{0,v}^{u_0,v} < \tau_{0,i+\phi+\sum_{p=1}^{\phi} \mu_p}^{u_{0,i+\phi+\sum_{p=1}^{\phi} \mu_p}}, \text{ for all } v,$$

$$(v) w_v \text{ of the form } w_{i+2,i+s_{\phi}+\mu_{\phi}} \in H_{i+s_{\phi}+\mu_{\phi}+1}(q), \text{ for all } v,$$

(vi) the scalars $f_v(q)$ are expressions of $q \in \mathbb{C}$ for all v .

Proof. We prove the relations by induction on the number of gaps. For the 1-gap word $\tau_{0,i}^{k_{0,i}} \cdot \tau_{i+s,i+s+\mu}^{k_{i+s,i+s+\mu}} \cdot \alpha$, where $\alpha \in H_n(q)$, we have:

$$\begin{aligned} A &\hat{=} \left[\prod_{\lambda=0}^{\mu} (q^{k_{i+s+\lambda}-1})^{s-1} \right] \cdot \tau_{0,i}^{k_{0,i}} \cdot \tau_{i+1,i+1+\mu}^{k_{i+1,i+1+\mu}} \cdot \prod_{\lambda=0}^{\mu} \delta_{i+2+\mu-\lambda,i+s+\mu-\lambda} \cdot \alpha \cdot \\ &\prod_{\lambda=0}^{\mu} \delta_{i+2+\mu+\lambda,i+s+\lambda} + \sum_v f_v(q) \cdot \tau_{0,v}^{u_{0,v}} \cdot w_v, \\ &\text{which holds from Proposition 3.3.} \end{aligned}$$

Suppose that the relation holds for $(\phi-1)$ -gap words. Then for a ϕ -gap word we have:

$$\begin{aligned} &\left(\tau_{0,i}^{k_{0,i}} \cdot \tau_{i+s_1,i+s_1+\mu_1}^{k_{i+s_1,i+s_1+\mu_1}} \cdot \tau_{i+s_2,i+s_2+\mu_2}^{k_{i+s_2,i+s_2+\mu_2}} \cdots \tau_{i+s_{\phi-1},i+s_{\phi-1}+\mu_{\phi-1}}^{k_{i+s_{\phi-1},i+s_{\phi-1}+\mu_{\phi-1}}} \right) \cdot \tau_{i+s_{\phi},i+s_{\phi}+\mu_{\phi}}^{k_{i+s_{\phi},i+s_{\phi}+\mu_{\phi}}} \cdot \alpha \hat{=}_{\text{ind.step}} \\ &\prod_{j=1}^{\phi-1} \left(q^{k_{i+s_j}-1} \right)^{s_j-j-\sum_{k=1}^{j-1} \mu_k} \cdot \tau_{0,i+\phi-1+\sum_{k=1}^{\phi-1} \mu_k}^{u_{0,i+\phi-1+\sum_{k=1}^{\phi-1} \mu_k}} \cdot \prod_{k=0}^{\phi-2} \alpha_{\phi-1-k} \cdot \tau_{i+s_{\phi},i+s_{\phi}+\mu_{\phi}}^{k_{i+s_{\phi},i+s_{\phi}+\mu_{\phi}}} \cdot \alpha \cdot \prod_{k=1}^{\phi-1} \alpha'_k + \\ &\sum_v f_v(q) \cdot \tau_{0,v}^{u_{0,v}} \cdot w \cdot \tau_{i+s_{\phi},i+s_{\phi}+\mu_{\phi}}^{k_{i+s_{\phi},i+s_{\phi}+\mu_{\phi}}} \cdot \alpha \cdot \prod_{k=1}^{\phi-1} \alpha'_k + \\ &\prod_{j=1}^{\phi-1} \left(q^{k_{i+s_j}-1} \right)^{s_j-j-\sum_{k=1}^{j-1} \mu_k} \cdot \tau_{0,i+\phi-1+\sum_{k=1}^{\phi-1} \mu_k}^{u_{0,i+\phi-1+\sum_{k=1}^{\phi-1} \mu_k}} \cdot \tau_{i+s_{\phi},i+s_{\phi}+\mu_{\phi}}^{k_{i+s_{\phi},i+s_{\phi}+\mu_{\phi}}} \cdot \prod_{k=0}^{\phi-2} \alpha_{\phi-1-k} \cdot \alpha \cdot \prod_{k=1}^{\phi-1} \alpha'_k + \\ &\sum_v f_v(q) \cdot \tau_{0,v}^{u_{0,v}} \cdot \tau_{i+s_{\phi},i+s_{\phi}+\mu_{\phi}}^{k_{i+s_{\phi},i+s_{\phi}+\mu_{\phi}}} \cdot w \stackrel{(\text{Prop. 3.3})}{=} \\ &\prod_{j=1}^{\phi-1} \left(q^{k_{i+s_j}-1} \right)^{s_j-j-\sum_{k=1}^{j-1} \mu_k} \cdot \prod_{p=0}^{\mu_{\phi}} \left(q^{k_{i+s_{\phi}+p}-1} \right)^{s_{\phi}-\phi-\sum_{k=1}^{\phi-1} \mu_k} \cdot \tau_{0,i+\phi-1+\sum_{k=1}^{\phi-1} \mu_k}^{u_{0,i+\phi-1+\sum_{k=1}^{\phi-1} \mu_k}} \cdot \\ &\tau_{i+\phi+\sum_{k=1}^{\phi-1} \mu_k,i+\phi+\sum_{k=1}^{\phi-1} \mu_k+\mu_{\phi}}^{k_{i+\phi+\sum_{k=1}^{\phi-1} \mu_k,i+\phi+\sum_{k=1}^{\phi-1} \mu_k+\mu_{\phi}}} \cdot \prod_{k=0}^{\phi-1} \alpha_{\phi-1-k} \cdot \alpha \cdot \prod_{k=1}^{\phi-1} \alpha'_k + \sum_v f_v(q) \cdot \tau_{0,v}^{u_{0,v}} \cdot \tau_{i+s_{\phi},i+s_{\phi}+\mu_{\phi}}^{k_{i+s_{\phi},i+s_{\phi}+\mu_{\phi}}} \cdot \\ &w \stackrel{(\text{Prop. 3.3})}{=} \\ &\left[\prod_{\lambda=0}^{\mu} (q^{k_{i+s+\lambda}-1})^{s-1} \right] \cdot \tau_{0,i}^{k_{0,i}} \cdot \tau_{i+1,i+1+\mu}^{k_{i+1,i+1+\mu}} \cdot \prod_{\lambda=0}^{\mu} \delta_{i+2+\mu-\lambda,i+s+\mu-\lambda} \cdot \alpha \cdot \prod_{\lambda=0}^{\mu} \delta_{i+2+\mu+\lambda,i+s+\lambda} + \\ &\sum_v f_v(q) \cdot \tau_{0,v}^{u_{0,v}} \cdot w_v. \quad \square \end{aligned}$$

All results are best demonstrated in the following example on a word with two gaps.

Example 3.3. For the 2-gap word $t^{k_0} t_1^{k_1} t_3 t_5^2 t_6^{-1} \in \Sigma_n$ we have:

$$\begin{aligned} t^{k_0} \underline{t_1^{k_1} t_3 t_5^2 t_6^{-1}} &= t^{k_0} t_1^{k_1} g_3 t_2 g_3 t_5^2 t_6^{-1} = g_3 t^{k_0} t_1^{k_1} t_2 t_5^2 t_6^{-1} g_3 \hat{=} t^{k_0} t_1^{k_1} \underline{t_2 t_5^2 t_6^{-1}} g_3^2 = \\ &= t^{k_0} t_1^{k_1} t_2 \underline{t_5 t_5 t_6^{-1}} g_3^2 = t^{k_0} t_1^{k_1} t_2 g_5 g_4 t_3 g_4 g_5 t_5 t_6^{-1} g_3^2 = \\ &= g_5 g_4 t^{k_0} t_1^{k_1} t_2 t_3 g_4 g_5 t_5 t_6^{-1} g_3^2 \hat{=} t^{k_0} t_1^{k_1} t_2 t_3 g_4 g_5 t_5 t_6^{-1} g_3^2 g_5 g_4 = \\ &= t^{k_0} t_1^{k_1} t_2 t_3 [q^2 t_3 g_4 g_5 + q(q-1) t_4 g_5 + (q-1) t_5 g_4] t_6^{-1} g_3^2 g_5 g_4 = \\ &= q^2 t^{k_0} t_1^{k_1} t_2 t_3 g_4 g_5 t_6^{-1} g_3^2 g_5 g_4 + q(q-1) t^{k_0} t_1^{k_1} t_2 t_3 t_4 g_5 t_6^{-1} g_3^2 g_5 g_4 + \end{aligned}$$

$$\begin{aligned}
& + (q-1)t^{k_0}t_1^{k_1}t_2t_3t_5\underline{g_4t_6^{-1}g_3^2g_5g_4} = q^2t^{k_0}t_1^{k_1}t_2t_3\underline{t_6^{-1}g_4g_5g_3^2g_5g_4} + \\
& + (q-1)t^{k_0}t_1^{k_1}t_2t_3t_5\underline{t_6^{-1}g_4g_3^2g_5g_4} + q(q-1)t^{k_0}t_1^{k_1}t_2t_3t_4\underline{t_6^{-1}g_5g_3^2g_5g_4} \hat{=} \\
& \hat{=} q^2t^{k_0}t_1^{k_1}t_2t_3\underline{g_6^{-1}g_5^{-1}t_4^{-1}g_5^{-1}g_6^{-1}g_4g_5g_3^2g_5g_4} + \\
& + q(q-1)t^{k_0}t_1^{k_1}t_2t_3t_4\underline{g_6^{-1}t_5^{-1}g_6^{-1}g_5g_3^2g_5g_4} + (q-1)t^{k_0}t_1^{k_1}t_2t_3\underline{g_5t_4g_5t_6^{-1}} \cdot \\
& \cdot (g_4g_3^2g_5g_4) = q^2g_6^{-1}g_5^{-1}t^{k_0}t_1^{k_1}t_2t_3\underline{t_4^{-1}g_5^{-1}g_6^{-1}g_4g_5g_3^2g_5g_4} + \\
& + q(q-1)g_6^{-1}t^{k_0}t_1^{k_1}t_2t_3t_4\underline{t_5^{-1}g_6^{-1}g_5g_3^2g_5g_4} + \\
& + (q-1)g_5t^{k_0}t_1^{k_1}t_2t_3t_4\underline{t_6^{-1}g_5g_4g_3^2g_5g_4} \hat{=} \\
& \hat{=} q^2t^{k_0}t_1^{k_1}t_2t_3\underline{t_4^{-1}g_5^{-1}g_6^{-1}g_4g_5g_3^2g_5g_4g_6^{-1}g_5^{-1}} + \\
& + q(q-1)t^{k_0}t_1^{k_1}t_2t_3t_4\underline{t_5^{-1}g_6^{-1}g_5g_3^2g_5g_4g_6^{-1}} + (q-1)t^{k_0}t_1^{k_1}t_2t_3t_4\underline{t_6^{-1}g_5} \cdot \\
& \cdot (g_4g_3^2g_5g_4g_5) = q^2t^{k_0}t_1^{k_1}t_2t_3\underline{t_4^{-1}g_5^{-1}g_6^{-1}g_4g_5g_3^2g_5g_4g_6^{-1}g_5^{-1}} + \\
& + q(q-1)t^{k_0}t_1^{k_1}t_2t_3t_4\underline{t_5^{-1}g_6^{-1}g_5g_3^2g_5g_4g_6^{-1}} + \\
& + (q-1)t^{k_0}t_1^{k_1}t_2t_3t_4\underline{g_6^{-1}t_5^{-1}g_6^{-1}g_5g_4g_3^2g_5g_4g_5} \hat{=} \\
& \hat{=} q^2t^{k_0}t_1^{k_1}t_2t_3\underline{t_4^{-1}g_5^{-1}g_6^{-1}g_4g_5g_3^2g_5g_4g_6^{-1}g_5^{-1}} + \\
& + q(q-1)t^{k_0}t_1^{k_1}t_2t_3t_4\underline{t_5^{-1}g_6^{-1}g_5g_3^2g_5g_4g_6^{-1}} + \\
& + (q-1)t^{k_0}t_1^{k_1}t_2t_3t_4\underline{t_5^{-1}g_6^{-1}g_5g_4g_3^2g_5g_4g_5g_6^{-1}}.
\end{aligned}$$

3.4.2 Ordering the exponents

We now deal with elements in Σ_n , where the looping generators have consecutive indices but their exponents are not in decreasing order. More precisely, we will show that these elements can be expressed as sums of elements in the $\bigcup_n H_n(q)$ -module Λ , namely, as sums of elements in Λ followed by a braiding tail.

We will need the following lemma.

Lemma 3.15. *The following relations hold in $H_{1,n}(q)$ for $\lambda \in \mathbb{N}$:*

$$t_i^k \cdot t_{i+1}^{k+\lambda} \hat{=} \sum_j t_i^{u_j} t_{i+1}^{v_j} \cdot w_j,$$

where $u_j + v_j = 2k + \lambda$, $u_j \geq v_j$ and $w_j \in H_n(q)$, $\forall j$.

$$\begin{aligned}
\text{Proof.} \quad & \text{We have that } t_i^k \cdot t_{i+1}^{k+\lambda} = t_i^k \cdot t_{i+1}^k t_{i+1}^\lambda \stackrel{L. 3.13}{=} \\
& = t_i^k \cdot t_{i+1}^k \cdot \left(q^{\lambda-1} g_{i+1} t_i^\lambda g_{i+1} + \sum_{j=0}^{\lambda-2} q^j (q-1) t_i^{j+1} t_{i+1}^{\lambda-1-j} \right) = \\
& = q^{\lambda-1} t_i^k \cdot t_{i+1}^k \cdot g_{i+1} t_i^\lambda g_{i+1} + \sum_{j=0}^{\lambda-2} q^j (q-1) t_i^{k+j+1} t_{i+1}^{k+\lambda-1-j}.
\end{aligned}$$

We obtained the term $t_i^k \cdot t_{i+1}^k \cdot g_{i+1} t_i^\lambda g_{i+1}$, terms where the exponent of t_i is greater than the exponent of t_{i+1} and terms of the form $t_i^{p_1} t_{i+1}^{p_2}$, where $k < p_1 > p_2 < k + \lambda$. We

apply Lemma 3.13 on the terms of the last form and repeat the same procedure until there are only elements of the form $t_i^{u_1} t_{i+1}^{u_2}$, $u_1 > u_2$ left in each sum. Note that each time Lemma 3.13 is performed, a term of the form $t_i^{m_1} \cdot t_{i+1}^{m_1} \cdot g_{i+1} t_i^{m_2} g_{i+1}$ appears. For these elements we have:

$$\begin{aligned} t_i^{m_1} \cdot \underline{t_{i+1}^{m_1} \cdot g_{i+1} t_i^{m_2} g_{i+1}} &\stackrel{L. 3}{=} t_i^{m_1} \cdot \left((q-1) \sum_{j=0}^{m_1-1} q^j t_i^j t_{i+1}^{m_1-j} + q^{m_1} g_{i+1} t_i^{m_1} \right) \cdot t_i^{m_2} g_{i+1} = \\ &= (q-1) \sum_{j=0}^{m_1-1} q^j t_i^{m_1+m_2+j} t_{i+1}^{m_1-j} g_{i+1} + q^{m_1} t_i^{m_1} \cdot g_{i+1} t_i^{m_1+m_2} \cdot g_{i+1}. \end{aligned}$$

We have obtained now elements where the exponent of t_i is greater than the exponent of t_{i+1} and the term $\underline{t_i^{m_1} \cdot g_{i+1} t_i^{m_1+m_2} \cdot g_{i+1}} \hat{=} t_i^{m_1+m_2} \cdot \underline{g_{i+1} t_i^{m_1} g_{i+1}} \stackrel{L. 3,4}{=}$
 $= t_i^{m_1+m_2} \cdot \left(q^{-m_1+1} t_{i+1}^{m_1-1} g_{i+1} + \sum_{j=1}^{m_1-1} q^{-m_1+1-j} (q^{-1}-1) t_i^j t_{i+1}^{m_1-j} \right)$ and this concludes the proof. \square

Remark 3.3. Let $\tau_{0,m}^{k_0,m} \in \Sigma_n$ such that $k_i < k_{i+1}$. Applying Lemma 3.15 on $\tau_{0,m}^{k_0,m}$ we obtain a sum of elements $\tau_j \in \Sigma_n$, such that $\tau_j < \tau$, $\forall j$, since the exponent of the generator t_{i+1} in τ_j is less than k_{i+1} for all j (see Definition 3.2).

Example 3.4. Consider the element $tt_1^2 t_2^3 \in \Sigma_n$ and apply Lemma 3.15 on the first “bad” exponent occurring in the word, starting from right to left.

$$\underline{tt_1^2 t_2^3} \hat{=} f_1(q) \cdot tt_1^3 t_2^2 \cdot w_1 + f_2(q) \cdot tt_1^4 t_2 \cdot w_2.$$

The terms obtained are still in Σ_n but they have one “bad” exponent less. We apply Lemma 3.15 again and obtain:

$$\begin{aligned} \underline{tt_1^3 t_2^2} &\hat{=} f_3(q) \cdot t^3 t_1 t_2^2 \cdot w_3 + f_4(q) \cdot t^2 t_1^2 t_2^2 \cdot w_4 \\ \underline{tt_1^4 t_2} &\hat{=} f_5(q) \cdot t^4 t_1 t_2 \cdot w_5 + f_6(q) \cdot t^3 t_1^2 t_2 \cdot w_6 \end{aligned}$$

All terms obtained now are in the $\bigcup_n H_n(q)$ -module Λ except from the element $t^3 t_1 t_2^2$. We apply Lemma 3.15 again and obtain:

$$\underline{t^3 t_1 t_2^2} \hat{=} f_7(q) \cdot t^3 t_1^2 t_2 \cdot w_7.$$

So:

$$tt_1^2 t_2^3 \hat{=} g_1(q) \cdot t^3 t_1^2 t_2 \cdot u_1 + g_2(q) \cdot t^2 t_1^2 t_2^2 \cdot u_2 + g_3(q) \cdot t^4 t_1 t_2 \cdot u_3$$

where $u_1, \dots, u_5 \in H_n(q)$ and $g_1(q), \dots, g_5(q) \in \mathbb{C}$.

Theorem 3.5. *Applying conjugation on an element in Σ_n we have that:*

$$\tau_{0,m}^{k_0,m} \cdot w \hat{=} \sum_j \tau_{0,j}^{\lambda_0,j} \cdot w_j,$$

where $\tau_{0,j}^{\lambda_0,j} \in \Lambda$ and $w, w_j \in H_n(q)$, $\forall j$.

Proof. We prove the statement by induction on the order of $\tau_{0,m}^{k_0,m} \cdot w \in \Sigma_n$, where order of an element in Σ_n denotes the position of this element in Σ_n with respect to total-ordering.

The base of the induction is Lemma 3.15 for $i = 0$. Suppose that the relation holds for all $\tau_j \cdot u_j \in \Sigma_n$ of less order than $\tau_{0,m}^{k_0,m} \cdot w$. Then, for $\tau_{0,m}^{k_0,m} \cdot w$ we have:

Let $k_0 > k_1 > \dots > k_i < k_{i+1}$. Applying Lemma 3.15 on $\tau_{0,m}^{k_0,m} \cdot w$ we obtain:
 $\tau_{0,m}^{k_0,m} \cdot w := t_0^{k_0} t_1^{k_1} \dots \underline{t_i^{k_i} t_{i+1}^{k_{i+1}}} \dots t_m^{k_m} \cdot w = \sum_j t_0^{k_0} t_1^{k_1} \dots t_i^{u_j} t_{i+1}^{v_j} \dots t_m^{k_m} \cdot w_j$, where $u_j > v_j < k_{i+1}$, $\forall j$, that is, a sum of lower order terms than $\tau_{0,m}^{k_0,m} \cdot w$ (see Remark 3.3). So, by the induction hypothesis, the relation holds. \square

3.4.3 Eliminating the tails

So far we have seen how to convert elements in the basis Λ' to sums of elements in Σ_n and then, using conjugation, how these elements are expressed as sums of elements in the $\bigcup_n H_n(q)$ -module Λ . We will show now that using conjugation and stabilization moves all these elements of the $\bigcup_n H_n(q)$ -module Λ are expressed to sums of elements in the set Λ with scalars in the field \mathbb{C} . We will use the symbol \simeq when a stabilization move is performed and $\widehat{\simeq}$ when both stabilization moves and conjugation are performed.

Let us consider a generic word in $H_{1,n+1}(q)$. This is of the form $\tau_{0,n}^{k_0,n} \cdot w_{n+1}$, where $w_{n+1} \in H_{n+1}(q)$. Without loss of generality we consider the exponent of the braiding generator with the highest index to be (-1) when the exponent of the corresponding loop generator is in \mathbb{N} and $(+1)$ when the exponent of the corresponding loop generator is in $\mathbb{Z} \setminus \mathbb{N}$. We then apply Lemma 3.3 and 3.4 in order to interact $t_n^{\pm k_n}$ with $g_n^{\mp 1}$ and obtain words of the following form:

- (1) $\tau_{0,p}^{\lambda_{0,p}} \cdot v$, where $\tau_{0,p}^{\lambda_{0,p}} < \tau_{0,n}^{k_0,n}$ and $v \in H_{n+1}(q)$ of any length, or
- (2) $\tau_{0,q}^{k_{0,q}} \cdot u$, where $\tau_{0,q}^{\lambda_{0,q}} < \tau_{0,n}^{k_0,n}$ and $u \in H_n(q)$ such that $l(u) < l(w)$.

In the first case we obtain monomials of t_i s of less order than the initial monomial, followed by a word in $H_{n+1}(q)$ of any length. After at most $(k_n + 1)$ -interactions of t_n with g_n , the exponent of t_n will become zero and so by applying a stabilization move we obtain monomials of t_i s of less index, and thus of less order (Definition 3.2), followed by a word in $H_n(q)$.

In the second case, we have monomials of t_i s of less order than the initial monomial followed by words $u \in H_n(q)$ such that $l(u) < l(w)$. We interact the generator with the maximum index of u , g_m with the corresponding loop generator until the exponent of t_m becomes zero. A gap in the indices of the monomials of the t_i s occurs and we apply Theorem 3.4. This leads to monomials of t_i s of less order followed by words of the braiding generators of any length. We then apply stabilization moves and repeat the same procedure until the braiding ‘tails’ are eliminated.

Theorem 3.6. *Applying conjugation and stabilization moves on a word in the $\bigcup_\infty H_n(q)$ -module, Λ we have that:*

$$\tau_{0,m}^{k_0,m} \cdot w_n \widehat{\simeq} \sum_j f_j(q, z) \cdot \tau_{0,u_j}^{v_0,u_j},$$

such that $\sum v_{0,u_j} = \sum k_{0,m}$ and $\tau_{0,u_j}^{v_{0,u_j}} < \tau_{0,m}^{k_{0,m}}$, for all j .

The logic for the induction hypothesis is explained above. We shall now proceed with the proof of the theorem.

Proof. We prove the statement by double induction on the length of $w_n \in H_n(q)$ and on the order of $\tau_{0,m}^{k_{0,m}} \in \Lambda$, where order of $\tau_{0,m}^{k_{0,m}}$ denotes the position of $\tau_{0,m}^{k_{0,m}}$ in Λ with respect to total-ordering.

For $l(w) = 0$, that is for $w = e$ we have that $\tau_{0,m}^{k_{0,m}} \cong \tau_{0,m}^{k_{0,m}}$ and there's nothing to show. Moreover, the minimal element in the set Λ is t^k and for any word $w \in H_n(q)$ we have that $t^k \cdot w \simeq f(q, z) \cdot t^k$, by the quadratic relation and stabilization moves.

Suppose that the relation holds for all $\tau_{0,p}^{u_{0,p}} \cdot w'$, where $\tau_{0,p}^{u_{0,p}} \leq \tau_{0,m}^{k_{0,m}}$ and $l(w') = l$, and for all $\tau_{0,q}^{v_{0,q}} \cdot w$, where $\tau_{0,q}^{v_{0,q}} < \tau_{0,m}^{k_{0,m}}$ and $l(w) = l + 1$. We will show that it holds for $\tau_{0,m}^{k_{0,m}} \cdot w$. Let the exponent of t_r , $k_r \in \mathbb{N}$ and let $w \in H_{r+1}(q)$. Then, w can be written as $w' \cdot g_r^{-1} \cdot \delta_{r-1,d}$, where $w' \in H_r(q)$ and $d < r$. We have that:

$$\begin{aligned} \tau_{0,m}^{k_{0,m}} \cdot w &= \tau_{0,r-1}^{k_{0,r-1}} t_r^{k_r-1} \tau_{r+1,m}^{k_{r+1,m}} \cdot w' \cdot t_r g_r^{-1} \delta_{r-1,d} = \\ &= \tau_{0,r-1}^{k_{0,r-1}} t_r^{k_r-1} \tau_{r+1,m}^{k_{r+1,m}} \cdot w' \cdot g_r \underline{t_{r-1} \delta_{r-1,d}} \stackrel{L. 6}{=} \\ &= \tau_{0,r-1}^{k_{0,r-1}} t_r^{k_r-1} \tau_{r+1,m}^{k_{r+1,m}} \cdot w' \cdot g_r \\ &\quad \cdot \left(\sum_{j=0}^{r-1-d} q^j (q-1) \delta_{r-1, \widehat{r-1-j,d}} t_{r-1-j} + q^{l(\delta_{r-1,d})} \delta_{r-1,d} t_{d-1} \right) \cong \\ &\cong \sum_{j=0}^{r-1-d} q^j (q-1) \tau_{0,r-1}^{k_{0,r-1}} t_r^{k_r-1} \tau_{r+1,m}^{k_{r+1,m}} \cdot t_{r-1-j} \cdot w' \cdot g_r \delta_{r-1, \widehat{r-1-j,d}} + \\ &+ q^{l(\delta_{r-1,d})} \tau_{0,r-1}^{k_{0,r-1}} t_r^{k_r-1} \tau_{r+1,m}^{k_{r+1,m}} \cdot t_{d-1} \cdot w. \end{aligned}$$

We have that $\left(\tau_{0,r-1}^{k_{0,r-1}} t_r^{k_r-1} \tau_{r+1,m}^{k_{r+1,m}} \cdot t_{r-1-j} \right) < \left(\tau_{0,m}^{k_{0,m}} \right)$, for all $j \in \{1, 2, \dots, r-1-d\}$ and $l\left(w' \cdot g_r \delta_{r-1, \widehat{r-1-j,d}} \right) = l$ and $\left(\tau_{0,r-1}^{k_{0,r-1}} t_r^{k_r-1} \tau_{r+1,m}^{k_{r+1,m}} \cdot t_{d-1} \right) < \left(\tau_{0,m}^{k_{0,m}} \right)$. So, by the induction hypothesis, the relation holds. \square

Example 3.5. In this example we demonstrate how to eliminate the braiding ‘tail’ in a word in Σ_n .

$$\begin{aligned} t^{-1} \underline{t_1^2 t_2^{-1}} g_1^{-1} &= t^{-1} t_1 t_2^{-1} t_1 g_1^{-1} = t^{-1} t_1 t_2^{-1} g_1 t \hat{=} t_1 t_2^{-1} g_1 = t_2^{-1} t_1 g_1 = \\ &= (q-1) t_1 t_2^{-1} + q t_2^{-1} g_1 t \hat{=} (q-1) t t_2^{-1} g_1^2 + q t t_2^{-1} g_1 = \\ &= (q-1) t t_1^{-1} g_2^{-1} g_1^2 g_2^{-1} + q t t_1^{-1} g_2^{-1} g_1 g_2^{-1}. \end{aligned}$$

We have that:

$$\begin{aligned} g_2^{-1} g_1 g_2^{-1} &= q^{-2} g_1 g_2 g_1 + q^{-1} (q^{-1} - 1) g_2 g_1 + q^{-1} (q^{-1} - 1) g_1 g_2 + \\ &+ (q^{-1} - 1)^2 g_1, \\ g_2^{-1} g_1^2 g_2^{-1} &= q^{-2} (q-1) g_1 g_2 g_1 - (q^{-1} - 1)^2 g_2 g_1 - (q^{-1} - 1)^2 g_1 g_2 + \\ &+ (q-1) (q^{-1} - 1)^2 g_1 + q (q^{-1} - 1) g_2^{-1} + 1, \end{aligned}$$

and so

$$\begin{aligned}
(q-1)tt_1^{-1}g_2^{-1}g_1^2g_2^{-1} &\cong ((q-1) + q^{-1}(q-1)^3) \cdot tt_1^{-1} - q^{-3}(q^{-1}-1)^3z^2 \cdot 1 + \\
&+ 3q^{-3}(q-1)^4z \cdot 1 - q^{-1}(q-1)^2z \cdot 1 - q^{-3}(q-1)^5 \cdot 1, \\
qtt_1^{-1}g_2^{-1}g_1g_2^{-1} &\cong z \cdot tt_1^{-1} + q^{-1}(q^{-1}-1)z^2 \cdot 1 + 2(q^{-1}-1)^2z \cdot 1 + \\
&+ q(q^{-1}-1)^3 \cdot 1.
\end{aligned}$$

3.5 The basis Λ of $\mathcal{S}(\text{ST})$

In this section we show that the set Λ is a linearly independent. This is done in two steps:

- We first relate the two sets Λ and Λ' via an infinite lower triangular matrix with invertible elements in the diagonal.
- Then, using the matrix mentioned above, we prove that the set Λ is linearly independent.

3.5.1 The infinite matrix

With the orderings given in Definition 3.2 we shall show that the infinite matrix converting elements of the basis Λ' to elements of the set Λ is a block diagonal matrix, where each block is an infinite lower triangular matrix with invertible elements in the diagonal. Note that applying conjugation and stabilization moves on an element of some Λ_k followed by a braiding part won't alter the sum of the exponents of the loop generators and thus, the resulted terms will belong to the set of the same level Λ_k . Fixing the level k of a subset of Λ' , the proof of Theorem 3.2 is equivalent to proving the following claims:

- (1) A monomial $w' \in \Lambda'_k \subseteq \Lambda'$ can be expressed as linear combinations of elements in $\Lambda_k \subseteq \Lambda$, v_i , followed by monomials in $H_n(q)$, with scalars in \mathbb{C} such that $\exists j : v_j = w \sim w'$.
- (2) Applying conjugation and stabilization moves on all v_i 's results in obtaining elements in Λ_k , u_i 's, such that $u_i < v_i$ for all i .
- (3) The coefficient of w is an invertible element in \mathbb{C} .
- (4) $\Lambda_k \ni w < u \in \Lambda_{k+1}$.

Indeed we have the following: Let $w' \in \Lambda'_k \subset \Lambda'$. Then, by Theorem 3.3 the monomial w' is expressed as a sum of elements in Σ_n , where the only term that isn't followed by a braiding part is the homologous monomial $w \in \Lambda_k \subset \Lambda$. Other terms in the sum involve lower order terms than w (with possible gaps in the indices and possible non ordered exponents) followed by a braiding part and words of the form $w \cdot \beta$, where $\beta \in H_n(q)$. Then, by Theorem 3.4 elements in Σ_n are expressed to linear combinations of elements in Σ_n with no gaps in the indices of the looping generators (regularizing

$$\begin{array}{c}
\Lambda' \ni \tau' \xrightarrow{\text{Thm.7}} \underbrace{q^A \cdot \tau}_{\substack{\Lambda \ni \tau \sim \tau' \\ q^A \in \mathbb{C}}} + \sum_i \underbrace{f_i(q, z) \cdot \tau \cdot w_i}_{\substack{\Lambda \ni \tau \sim \tau' \\ f_i(q, z) \in \mathbb{C}, \forall i \\ w_i \in H_n(q), \forall i}} + \sum_i \underbrace{g_i(q, z) \cdot \tau_i \cdot u_i}_{\substack{\Sigma_n \ni \tau_i < \tau, \forall i \\ g_i(q, z) \in \mathbb{C}, \forall i \\ u_i \in H_n(q), \forall i}} \\
\downarrow \text{Thm.10} \qquad \qquad \qquad \downarrow \text{Thm.8} \\
\sum_j \underbrace{f_j(q, z) \cdot T_j}_{\substack{\Sigma_n \ni T_j < \tau, \forall j \\ f_j(q, z) \in \mathbb{C}, \forall j}} \xrightarrow{\text{Thm.10}} \sum_j \underbrace{g_j(q, z) \cdot T_j \cdot u_j}_{\substack{\Sigma_n \ni T_j < \tau, \forall j \\ g_j(q, z) \in \mathbb{C}, \forall j \\ u_j \in H_n(q), \forall j}} \\
\downarrow \text{Thm.9} \\
\sum_j \underbrace{h_j(q, z) \cdot T_j \cdot v_j}_{\substack{\Lambda \ni T_j < \tau, \forall j \\ v_j \in H_n(q), \forall j \\ h_j(q, z) \in \mathbb{C}, \forall j}} \\
\downarrow \text{Thm.10} \cdot \text{Thm.9} \\
\sum_i \underbrace{F_i(q, z) \cdot \lambda_i}_{\substack{\Lambda \ni \lambda_i < \tau, \forall i \\ F_i(q, z) \in \mathbb{C}, \forall i}}
\end{array}$$

Fig. 3.8: From Λ' to Λ .

elements with gaps) and obtaining words which are of less order than the initial word w . Then, by Theorem 3.5 we express these elements to linear combinations of elements in the $H_n(q)$ -module Λ , again of less order than w . In Theorem 3.6 all elements that are followed by a braiding part are expressed as sums of monomials in t_i 's with coefficients in \mathbb{C} . It is essential to mention that when applying Theorem 3.6 to a word of the form $w \cdot \beta$ one obtains monomials in t_i 's that are less ordered that w . Some of these monomials in t_i 's are in Λ and some have their exponents in non decreasing order, but all monomials are of less order than w . We apply again Theorem 3.5 on these monomials τ that don't belong in the set Λ and obtain words of less order than τ , followed by a braiding part. We only consider now the monomials not in Λ and perform Theorem 3.5. We obtain elements in the $H_n(q)$ -module Λ of less order than the initial monomials, followed by a braiding part. Eventually this procedure stops at the lower order term of Λ_k , t^k . So we have obtained elements in Λ of lower order terms than the initial element w , and thus, we obtain a lower triangular matrix with entries in the diagonal of the form q^{-A} (see Theorem 3.3), which are invertible elements in \mathbb{C} . The fourth claim follows directly from Definition 3.2.

If we denote as $[\Lambda_k]$ the block matrix converting elements in Λ'_k to elements in Λ_k for some k , then the change of basis matrix will be of the form:

$$S = \begin{bmatrix} \ddots & 0 & 0 & 0 & 0 & 0 & \\ & [\Lambda_{k-2}] & 0 & 0 & 0 & 0 & \\ & 0 & [\Lambda_{k-1}] & 0 & 0 & 0 & \\ & 0 & 0 & [\Lambda_k] & 0 & 0 & \\ & 0 & 0 & 0 & [\Lambda_{k+1}] & 0 & \\ & 0 & 0 & 0 & 0 & [\Lambda_{k+2}] & \\ & 0 & 0 & 0 & 0 & 0 & \ddots \end{bmatrix}$$

The infinite block diagonal matrix

3.5.2 Linear independence of Λ

Theorem 3.7. *The set Λ is linearly independent.*

Proof. Consider an arbitrary subset of Λ with finite many elements $\tau_1, \tau_2, \dots, \tau_k$. Without loss of generality we consider $\tau_1 < \tau_2 < \dots < \tau_k$ according to Definition 3.2. We convert now each element $\tau_i \in \Lambda$ to linear combination of elements in Λ' according to the infinite matrix. We have that

$$\tau_i \cong A_i \tau'_i + \sum_j A_j \tau'_j,$$

where $\tau'_i \sim \tau_i$, $A_i \in \mathbb{C} \setminus \{0\}$, $\tau'_j < \tau'_i$ and $A_j \in \mathbb{C}, \forall j$.

So, we have that:

$$\begin{aligned} \tau_1 &\cong A_1 \tau'_1 + \sum_j A_{1j} \tau'_{1j} \\ \tau_2 &\cong A_2 \tau'_2 + \sum_j A_{2j} \tau'_{2j} \\ &\vdots \\ \tau_{k-1} &\cong A_{k-1} \tau'_{k-1} + \sum_j A_{(k-1)j} \tau'_{(k-1)j} \\ \tau_k &\cong A_k \tau'_k + \sum_j A_{kj} \tau'_{kj} \end{aligned}$$

Note that each τ'_i can occur as an element in the sum $\sum_j A_{pj} \tau'_{pj}$ for $p > i$. We consider now the equation $\sum_{i=1}^k \lambda_i \cdot \tau_i = 0$, $\lambda_i \in \mathbb{C}, \forall i$ and we show that this holds only when $\lambda_i = 0, \forall i$. Indeed, we have:

$$\sum_{i=1}^k \lambda_i \cdot \tau_i = 0 \Leftrightarrow \lambda_k A_k \tau'_k + \sum_{i=1}^k \sum_j \lambda_i A_{ij} \tau'_{ij} = 0,$$

where $\tau'_k > \tau'_{ij}, \forall i, j$. So we conclude that $\lambda_k = 0$. Using the same argument we have that:

$$\sum_{i=1}^k \lambda_i \cdot \tau_i = 0 \Leftrightarrow \sum_{i=1}^{k-1} \lambda_i \cdot \tau_i = 0 \Leftrightarrow \lambda_{k-1} A_{k-1} \tau'_{k-1} + \sum_{i=1}^{k-1} \sum_j \lambda_i A_{ij} \tau'_{ij} = 0,$$

where $\tau'_{k-1} > \tau'_{ij}, \forall i, j$. So, $\lambda_{k-1} = 0$. Retrospectively we get:

$$\sum_{i=1}^k \lambda_i \cdot \tau_i = 0 \Leftrightarrow \lambda_i = 0, \forall i,$$

and so an arbitrary finite subset of Λ is linearly independent. Thus, the set Λ is linearly independent. \square

3.5.3 The proof of the main result

By Theorems 3.3, 3.4, 3.5 and 3.6 the set Λ is a spanning set of $\mathcal{S}(\text{ST})$. By Theorem 3.7 the set Λ is also linearly independent. Thus, it forms a basis for $\mathcal{S}(\text{ST})$ and the proof of Theorem 3.2 is now concluded. QED

3.6 Appendix

In this section we prove a series of lemmas converting elements in Σ_n in sums of elements in Σ'_n . The results presented in this section are used in Chapter 4 towards the computation of $S(L(p, 1))$. Moreover, they can be used in order provide a more straightforward proof that the set Σ'_n forms a basis for $H_{1,n}(q)$, given that the set Σ_n is a basic set.

3.6.1 From Σ_n to Σ'_n

Following notation 3.1, we denote by $\tau'^{\lambda_0, m}_{0, m}$ the element $t^{\lambda_0} \cdot t_m^{\lambda_m} \in \Lambda'$. The following lemma is analogous to Lemma 3.11.

Lemma 3.16. *For $i \in \mathbb{N}$, $k \in \mathbb{Z}$, the following relations hold in $H_{1,n}(q)$:*

$$t_i^k = q^{k \cdot i} t_i'^k + \sum_j f_j(q, z) \cdot \tau'^{\lambda_0, j}_{0, j},$$

where $\sum_{m=0}^j \lambda_m = k$ such that $\lambda_j < k$.

Proof. The proof is by induction on k and is analogous to that of Lemma 3.11. \square

Theorem 3.8. *The following relations hold in $H_{1,n}(q)$ for $k \in \mathbb{N}$:*

$$t^{k_0} t_1^{k_1} \dots t_m^{k_m} = q^{\sum_{n=1}^m n k_n} \cdot t^{k_0} t_1'^{k_1} \dots t_m'^{k_m} + \sum_i f_i(q, z) \cdot \tau'^{\lambda_0, i}_{0, i}$$

where $\tau'^{\lambda_0, i}_{0, i} < t^{k_0} t_1^{k_1} \dots t_m^{k_m}$, $\forall i$, $\sum_{j=0}^i \lambda_j = \sum_{i=0}^m k_i$, $\lambda_j \in \mathbb{N} \forall j$, such that $\lambda_m < k_m$ and if $\exists v : \lambda_v = 0$, then $\lambda_j = 0 \forall j > v$.

Proof. The relations are straightforward from the change of basis matrix. Alternatively, induction on the order of $\tau'^{k_0, m}_{0, m}$ could also be applied. \square

3.6.2 Useful lemmas

Lemma 3.17. For $\varepsilon = \pm 1$, the following relations hold in $H_{1,n}(q)$:

$$\begin{aligned} (i) \quad & g_1^{\pm 1} t^{\pm k} g_1^{\mp 1} t^{\pm 1} = t^{\pm 1} g_1^{\pm 1} t^{\pm k} g_1^{\pm 1} + (1 - q^{\mp 1}) t^{\pm k} g_1^{\pm 1} t^{\pm 1} + (q^{\mp 1} - 1) g_1^{\pm 1} t^{\pm(k+1)} \\ (ii) \quad & g_1 t^k g_1^{-1} t^{-1} = t^{-1} g_1 t^k g_1^{-1} + (1 - q^{-1}) t^{-1} g_1 t^k + (q^{-1} - 1) t^{(k-1)} g_1 \\ (iii) \quad & t^{-1} g_1^{-1} t^k g_1 = g_1^{-1} t^k g_1 t^{-1} + (1 - q^{-1}) t^k g_1 t^{-1} + (q^{-1} - 1) g_1 t^{(k-1)} \end{aligned}$$

Proof. We only prove relations (i) for $\varepsilon = 1$. Relations (ii) and (iii) follow similarly.

$$\begin{aligned} g_1 t^k g_1^{-1} t &= q^{-1} g_1 t^k g_1 t + (q^{-1} - 1) g_1 t^{(k+1)} = \\ &= q^{-1} [t g_1 t^k g_1 - (q - 1) t g_1 t^k - (1 - q) t^k g_1 t] + (q^{-1} - 1) g_1 t^{k+1} = \\ &= q^{-1} t g_1 t^k g_1 + q^{-1} (1 - q) t g_1 t^k + q^{-1} (q - 1) t^k g_1 t + q^{-1} (1 - q) g_1 t^{k+1} = \\ &= t g_1 t^k g_1^{-1} + (1 - q^{-1}) t g_1 t^k + (q^{-1} - 1) t g_1 t^k + (1 - q^{-1}) t^k g_1 t + (q^{-1} - 1) g_1 t^{k+1} = \\ &= t g_1 t^k g_1 + (1 - q^{-1}) t^k g_1 t + (q^{-1} - 1) g_1 t^{(k+1)}. \end{aligned}$$

□

Lemma 3.18. For $\varepsilon = \pm 1$, the following relations hold in $H_{1,n}(q)$:

$$g_1^{\varepsilon} t^{\varepsilon k} g_1^{-\varepsilon} t^{\varepsilon \lambda} = t^{\varepsilon \lambda} g_1^{\varepsilon} t^{\varepsilon k} g_1^{-\varepsilon} + (1 - q^{-\varepsilon}) \sum_{j=1}^{\lambda} t^{\varepsilon(k+\lambda-j)} g_1^{\varepsilon} t^{\varepsilon j} + (q^{-1} - 1) \sum_{j=1}^{\lambda} t^{\varepsilon(\lambda-j)} g_1^{\varepsilon} t^{\varepsilon(\kappa+j)}.$$

Proof. We only prove the case where $\varepsilon = 1$ by induction on λ :

For $\lambda = 1$ we have:

$$g_1 t^k g_1^{-1} t = t g_1 t^k g_1 + (1 - q^{-1}) t^k g_1 t + (q^{-1} - 1) g_1 t^{(k+1)}.$$

Suppose that the relation holds for $\lambda = i$. Then for $\lambda = i + 1$ we have:

$$\begin{aligned} g_1 t^k g_1^{-1} t^{i+1} &= (g_1 t^k g_1^{-1} t^i) t \stackrel{ind.step}{=} \\ &= t^i \underline{g_1 t^k g_1^{-1} t} + (1 - q^{-1}) \sum_{j=1}^i t^{(k+i-j)} g_1 t^j t + (q^{-1} - 1) \sum_{j=1}^i t^{(i-j)} g_1 t^{(\kappa+j)} t = \\ &= t^{i+1} g_1 t^k g_1^{-1} + (1 - q^{-1}) t^{k+1} g_1 t + (q^{-1} - 1) t^i g_1 t^{k+1} + \\ &+ (1 - q^{-1}) \sum_{j=1}^i t^{(k+i-j)} g_1 t^{j+1} + (q^{-1} - 1) \sum_{j=1}^i t^{(i-j)} g_1 t^{(\kappa+j+1)} = \\ &= t^{i+1} g_1 t^k g_1^{-1} + (1 - q^{-1}) \sum_{j=1}^{i+1} t^{(k+i-j)} g_1 t^j + (q^{-1} - 1) \sum_{j=1}^{i+1} t^{(i-j)} g_1 t^{(\kappa+j)}. \end{aligned}$$

□

Lemma 3.19. For the expression $A = (g_i g_{i-1} \dots g_{j+2} g_{j+1} g_{j+2}^{-1} \dots g_i^{-1}) t'_k$ the following

relations hold for the different values of $k \in \mathbb{N}$:

$$\begin{aligned}
(1) \quad A &= t'_k(g_i g_{i-1} \cdots g_{j+2} g_{j+1} g_{j+2}^{-1} \cdots g_i^{-1}), && \text{for } k > i \text{ or } k < j \\
(2) \quad A &= (q-1)t'_i + qt'_j(g_i g_{i-1} \cdots g_{j+2} g_{j+1} g_{j+2}^{-1} \cdots g_i^{-1}), && \text{for } k = i \\
(3) \quad A &= t'_i(g_i g_{i-1} \cdots g_{j+2} g_{j+1} g_{j+2}^{-1} \cdots g_i^{-1}), && \text{for } k = j \\
(4) \quad A &= (q-1)t'_{j+1}(g_i g_{i-1} \cdots g_{j+2} g_{j+1} g_{j+2} g_{j+3}^{-1} \cdots g_i^{-1}) + \\
&\quad + (q-1)^2 t'_i(g_i g_{i-1} \cdots g_{j+2} g_{j+1} g_{j+2} g_{j+3}^{-1} \cdots g_i^{-1}) - \\
&\quad - (q-1)^2 t'_{j+1}(g_i g_{i-1} \cdots g_{j+3} g_{j+1} g_{j+2} g_{j+3}^{-1} \cdots g_i^{-1}) + \\
&\quad + q(q-1)t'_i(g_i g_{i-1} \cdots g_{j+2} g_{j+3}^{-1} \cdots g_i^{-1}) + \\
&\quad + qt'_j(g_i g_{i-1} \cdots g_{j+2} g_{j+1} g_{j+3}^{-1} \cdots g_i^{-1}) + \\
&\quad + q(1-q)t'_j(g_i g_{i-1} \cdots g_{j+2} g_{j+3}^{-1} \cdots g_i^{-1}), && \text{for } k = j+1 < i. \\
(5) \quad A &= (q-1)t'_k(g_i g_{i-1} \cdots g_{j+2} g_{j+1} g_{j+2}^{-1} \cdots g_{k-1} g_{k+2}^{-1} \cdots g_i^{-1}) + \\
&\quad + (q-1)^2 t'_i(g_i g_{i-1} \cdots g_{j+2} g_{j+1} g_{j+2}^{-1} \cdots g_{k-1} g_{k+2}^{-1} \cdots g_i^{-1}) - \\
&\quad - (q-1)^2 t'_k(g_i g_{i-1} \cdots g_{j+2} g_{j+1} g_{j+2}^{-1} \cdots g_{k-1} g_{k+2}^{-1} \cdots g_i^{-1}) + \\
&\quad + qt'_j(g_i g_{i-1} \cdots g_{j+2} g_{j+1} g_{j+2}^{-1} \cdots g_{k-1} g_k^{-1} g_{k+2}^{-1} \cdots g_i^{-1}) + \\
&\quad + q(q-1)t'_i(g_i g_{i-1} \cdots g_{k+1} g_{k+2}^{-1} \cdots g_i^{-1}) - \\
&\quad - q(q-1)t'_j(g_i g_{i-1} \cdots g_{k+1} g_{k+2}^{-1} \cdots g_i^{-1}), && \text{for } j+1 < k < i.
\end{aligned}$$

Proof. The first three relations come from the definition of t'_i . We prove relations (4) and (5), which are more complicated.

$$\begin{aligned}
(4) \quad A &= g_i g_{i-1} \cdots g_{j+2} g_{j+1} g_{j+2}^{-1} g_{j+3}^{-1} \cdots g_i^{-1} t'_{j+1} = \\
&= g_i g_{i-1} \cdots g_{j+2} g_{j+1} g_{j+2}^{-1} t'_{j+1} (g_{j+3}^{-1} \cdots g_i^{-1}) = \\
&= g_i g_{i-1} \cdots g_{j+2} g_{j+1} ((q-1)t'_{j+2} g_{j+2} + qt'_{j+1}) (g_{j+3}^{-1} \cdots g_i^{-1}) = \\
&= (q-1)g_i g_{i-1} \cdots g_{j+2} t'_{j+2} g_{j+1} g_{j+2} g_{j+3}^{-1} \cdots g_i^{-1} + \\
&\quad + qg_i g_{i-1} \cdots g_{j+2} g_{j+1} t'_{j+1} g_{j+3}^{-1} \cdots g_i^{-1} = \\
&= (q-1)t'_{j+1}(g_i g_{i-1} \cdots g_{j+2} g_{j+1} g_{j+2} g_{j+3}^{-1} \cdots g_i^{-1}) + \\
&\quad + (q-1)^2 t'_i(g_i g_{i-1} \cdots g_{j+2} g_{j+1} g_{j+2} g_{j+3}^{-1} \cdots g_i^{-1}) - \\
&\quad - (q-1)^2 t'_{j+1}(g_i g_{i-1} \cdots g_{j+3} g_{j+1} g_{j+2} g_{j+3}^{-1} \cdots g_i^{-1}) + \\
&\quad + q(q-1)t'_i(g_i g_{i-1} \cdots g_{j+2} g_{j+3}^{-1} \cdots g_i^{-1}) + \\
&\quad + qt'_j(g_i g_{i-1} \cdots g_{j+2} g_{j+1} g_{j+3}^{-1} \cdots g_i^{-1}) + \\
&\quad + q(1-q)t'_j(g_i g_{i-1} \cdots g_{j+2} g_{j+3}^{-1} \cdots g_i^{-1})
\end{aligned}$$

$$\begin{aligned}
(5) \quad A &= g_i g_{i-1} \cdots g_{j+2} g_{j+1} g_{j+2}^{-1} g_{j+3}^{-1} \cdots g_i^{-1} t'_k = \\
&= g_i g_{i-1} \cdots g_{k+1} g_k g_{k-1} \cdots g_{j+2} g_{j+1} g_{j+2}^{-1} \cdots g_{k-1}^{-1} g_k^{-1} g_{k+1}^{-1} \cdots g_i^{-1} t'_k = \\
&= g_i g_{i-1} \cdots g_{k+1} g_k g_{k-1} \cdots g_{j+2} g_{j+1} g_{j+2}^{-1} \cdots g_{k-1}^{-1} g_k^{-1} (g_{k+1}^{-1} t'_k) \cdots g_i^{-1} = \\
&= g_i g_{i-1} \cdots g_{k+1} g_k g_{k-1} \cdots g_{j+1} g_{j+2}^{-1} \cdots g_k^{-1} ((q-1)t'_{k+1} g_k + q t'_k) \cdots g_i^{-1} = \\
&= (q-1) g_i g_{i-1} \cdots g_{k+1} t'_{k+1} g_k g_{k-1} \cdots g_{j+2} g_{j+1} g_{j+2}^{-1} \cdots g_{k-1}^{-1} g_k^{-1} g_{k+2}^{-1} \cdots g_i^{-1} + \\
&\quad + q g_i g_{i-1} \cdots g_{k+1} g_k g_{k-1} \cdots g_{j+2} g_{j+1} g_{j+2}^{-1} \cdots g_{k-1}^{-1} g_k t'_k g_{k+2}^{-1} \cdots g_i^{-1} = \\
&= (q-1) g_i g_{i-1} \cdots g_{k+2} t'_k g_{k+1} + \\
&\quad + (q-1) t'_{k+1} + (1-q) t'_k g_k g_{k-1} \cdots g_{j+2} g_{j+1} g_{j+2}^{-1} \cdots g_{k-1}^{-1} g_{k+2}^{-1} \cdots g_i^{-1} + \\
&\quad + q g_i g_{i-1} \cdots g_{k+1} g_k g_{k-1} \cdots g_{j+2} g_{j+1} g_{j+2}^{-1} \cdots g_{k-1}^{-1} t'_{k-1} g_{k-1}^{-1} g_{k+2}^{-1} \cdots g_i^{-1} = \\
&= (q-1) t'_k g_i g_{i-1} \cdots g_{k+1} g_k g_{k-1} \cdots g_{j+2} g_{j+1} g_{j+2}^{-1} \cdots g_k^{-1} g_{k+2}^{-1} \cdots g_i^{-1} + \\
&\quad + (q-1)^2 t'_i g_i g_{i-1} \cdots g_{k+1} g_k g_{k-1} \cdots g_{j+2} g_{j+1} g_{j+2}^{-1} \cdots g_{k-1}^{-1} g_{k+2}^{-1} \cdots g_i^{-1} - \\
&\quad - (q-1)^2 t'_k g_i g_{i-1} \cdots g_{k+2} g_k g_{k-1} \cdots g_{j+2} g_{j+1} g_{j+2}^{-1} \cdots g_{k-1}^{-1} g_{k+2}^{-1} \cdots g_i^{-1} + \\
&\quad + q g_i g_{i-1} \cdots g_{j+2} (g_{j+1} t'_{j+1}) g_{j+2}^{-1} \cdots g_{k-1}^{-1} g_k^{-1} g_{k+2}^{-1} \cdots g_i^{-1} = \\
&= (q-1) t'_k (g_i g_{i-1} \cdots g_{j+2} g_{j+1} g_{j+2}^{-1} \cdots g_{k-1}^{-1} g_{k+2}^{-1} \cdots g_i^{-1}) + \\
&\quad + (q-1)^2 t'_i (g_i g_{i-1} \cdots g_{j+2} g_{j+1} g_{j+2}^{-1} \cdots g_{k-1}^{-1} g_{k+2}^{-1} \cdots g_i^{-1}) - \\
&\quad - (q-1)^2 t'_k (g_i g_{i-1} \cdots g_{j+2} g_{j+1} g_{j+2}^{-1} \cdots g_{k-1}^{-1} g_{k+2}^{-1} \cdots g_i^{-1}) + \\
&\quad + q t'_j (g_i g_{i-1} \cdots g_{j+2} g_{j+1} g_{j+2}^{-1} \cdots g_{k-1}^{-1} g_k^{-1} g_{k+2}^{-1} \cdots g_i^{-1}) + \\
&\quad + q(q-1) t'_i (g_i g_{i-1} \cdots g_{k+1} g_{k+2}^{-1} \cdots g_i^{-1}) - \\
&\quad - q(q-1) t'_j (g_i g_{i-1} \cdots g_{k+1} g_{k+2}^{-1} \cdots g_i^{-1}).
\end{aligned}$$

□

Lemma 3.20. *The following relations hold in $H_{1,n}(q)$:*

$$\begin{aligned}
(g_i \cdots g_1^2 \cdots g_i) t'_i &= t(g_i \cdots g_1^2 \cdots g_i) + q^{i-1} (q^2 - q + 1) (t'_i - t) + \\
&\quad + \sum_{k=1}^{i-1} q^{i-(k+1)} (q-1) (t'_k - t) (g_i \cdots g_{k+1} g_{k+2}^{-1} \cdots g_i^{-1}) (g_k \cdots g_1^2 \cdots g_k) + \\
&\quad + \sum_{k=1}^{i-1} q^{i-(k+1)} (q-1)^2 (t'_i - t'_k) (g_k \cdots g_1^2 \cdots g_k)
\end{aligned}$$

Proof. We prove the relations by induction on i . For $i = 1$ we have: $g_1^2 t'_1 = t g_1^2 + (q^2 - q + 1)(t'_1 - t)$. Suppose that it holds for $i = \lambda \in \mathbb{N}^*$. Then, for $i = \lambda + 1$ we have:

$$\begin{aligned}
&(g_{\lambda+1} \cdots g_1^2 \cdots g_\lambda) \underline{g_{\lambda+1} t'_{\lambda+1}} = \\
&= (g_{\lambda+1} \cdots g_1^2 \cdots g_\lambda) (t'_\lambda g_{\lambda+1} + (q-1) t'_{\lambda+1} - (q-1) t'_\lambda) = \\
&= g_{\lambda+1} (g_\lambda \cdots g_1^2 \cdots g_\lambda t'_\lambda) (g_{\lambda+1} - (q-1)) + (q-1) g_{\lambda+1} t'_{\lambda+1} (g_\lambda \cdots g_1^2 \cdots g_\lambda) = \\
&= t(g_{\lambda+1} \cdots g_1^2 \cdots g_{\lambda+1}) - (q-1) t(g_{\lambda+1} \cdots g_1^2 \cdots g_\lambda) + q^\lambda (q^2 - q + 1) (t'_{\lambda+1} - t) + \\
&\quad + g_{\lambda+1} \sum_{k=1}^{\lambda-1} q^{\lambda-(k+1)} (q-1) (t'_k - t) (g_\lambda \cdots g_{k+1} g_{k+2}^{-1} \cdots g_\lambda^{-1}) (g_k \cdots g_1^2 \cdots g_k) q g_{\lambda+1}^{-1} + \\
&\quad + g_{\lambda+1} \sum_{k=1}^{\lambda-1} q^{\lambda-(k+1)} (q-1)^2 (t'_\lambda - t'_k) (g_k \cdots g_1^2 \cdots g_k) q g_{\lambda+1}^{-1} + (q-1) t'_\lambda g_{\lambda+1} \cdots g_1^2 \cdots g_\lambda + \\
&\quad + (q-1)^2 t'_{\lambda+1} g_\lambda \cdots g_1^2 \cdots g_\lambda - (q-1)^2 t'_\lambda g_\lambda \cdots g_1^2 \cdots g_\lambda = \\
&= t(g_{\lambda+1} \cdots g_1^2 \cdots g_{\lambda+1}) + (q-1) (t'_\lambda - t) (g_{\lambda+1} \cdots g_1^2 \cdots g_\lambda) + \\
&\quad + (q-1)^2 (t'_{\lambda+1} - t'_\lambda) (g_{\lambda+1} \cdots g_1^2 \cdots g_\lambda) +
\end{aligned}$$

$$\begin{aligned}
& +q \sum_{k=1}^{\lambda-1} q^{(\lambda+1)-(k+1)}(q-1)(t'_k - t)(g_{\lambda+1} \cdots g_{k+1} g_{k+2}^{-1} \cdots g_{\lambda}^{-1})(g_k \cdots g_1^2 \cdots g_k) + \\
& + \sum_{k=1}^{\lambda-1} q^{(\lambda+1)-(k+1)}(q-1)^2(t'_{\lambda+1} - t'_k)(g_k \cdots g_1^2 \cdots g_k) + q^\lambda(q^2 - q + 1)(t'_{\lambda+1} - t) = \\
& = t(g_{\lambda+1} \cdots g_1^2 \cdots g_{\lambda+1}) + q^{(\lambda+1)-1}(q^2 - q + 1)(t'_{\lambda+1} - t) + \\
& + \sum_{k=1}^{\lambda} q^{(\lambda+1)-(k+1)}(q-1)(t'_k - t)(g_{\lambda+1} \cdots g_{k+1} g_{k+2}^{-1} \cdots g_{\lambda+1}^{-1})(g_k \cdots g_1^2 \cdots g_k) + \\
& + \sum_{k=1}^{\lambda} q^{(\lambda+1)-(k+1)}(q-1)^2(t'_{\lambda+1} - t'_k)(g_k \cdots g_1^2 \cdots g_k). \quad \square
\end{aligned}$$

Lemma 3.21. *The following relations hold in $H_{1,n}(q)$:*

$$\begin{aligned}
(g_i \cdots g_1^2 \cdots g_i) t_i'^{\lambda} & = t^\lambda(g_i \cdots g_1^2 \cdots g_i) + q^{i-1}(q^2 - q + 1)(t_i'^{\lambda} - t^\lambda) + \\
& + \sum_{k=1}^{i-1} q^{i-(k+1)}(q-1)(t_k'^{\lambda} - t^\lambda)(g_i \cdots g_{k+2}^{-1} \cdots g_i^{-1})(g_k \cdots g_1^2 \cdots g_k) + \\
& + \sum_{k=1}^{i-1} q^{i-(k+1)}(q-1)^2(t_i'^{\lambda} - t_k'^{\lambda})(g_k \cdots g_1^2 \cdots g_k).
\end{aligned}$$

Proof. We prove the relation by induction on λ . For $\lambda = 1$ we have:

$$\begin{aligned}
(g_i \cdots g_1^2 \cdots g_i) t_i' & = t(g_i \cdots g_1^2 \cdots g_i) + q^{i-1}(q^2 - q + 1)(t_i' - t) + \\
& + \sum_{k=1}^{i-1} q^{i-(k+1)}(q-1)(t'_k - t)(g_i \cdots g_{k+1} g_{k+2}^{-1} \cdots g_i^{-1})(g_k \cdots g_1^2 \cdots g_k) + \\
& + \sum_{k=1}^{i-1} q^{i-(k+1)}(q-1)^2(t_i' - t'_k)(g_k \cdots g_1^2 \cdots g_k), \text{ which holds.}
\end{aligned}$$

Suppose now that the relation holds for $\lambda = \nu \in \mathbb{Z}$. Then, for $\lambda = \nu + 1$ we have:

$$\begin{aligned}
(g_i \cdots g_1^2 \cdots g_i) t_i'^{\nu+1} & = \underline{(g_i \cdots g_1^2 \cdots g_i t_i'^{\nu}) t_i'} \stackrel{ind.step}{=} \\
& = t^\nu(g_i \cdots g_1^2 \cdots g_i t_i') + q^{i-1}(q^2 - q + 1)(t_i'^{\nu+1} - t^\nu t_i') + \\
& + \sum_{k=1}^{i-1} q^{i-(k+1)}(q-1)(t_k'^{\nu} - t^\nu)(g_i \cdots g_{k+1} g_{k+2}^{-1} \cdots g_i^{-1})(g_k \cdots g_1^2 \cdots + g_k t_i') + \\
& + \sum_{k=1}^{i-1} q^{i-(k+1)}(q-1)^2(t_i'^{\nu} - t_k'^{\nu})(g_k \cdots g_1^2 \cdots g_k t_i') = \\
& = t^{\nu+1}(g_i \cdots g_1^2 \cdots g_i) + q^{i-1}(q^2 - q + 1)(t_i'^{\nu+1} - t^{\nu+1}) + \\
& + \sum_{k=1}^{i-1} q^{i-(k+1)}(q-1)(t^\nu t_k' - t^{\nu+1})(g_i \cdots g_1^2 \cdots g_k g_{k+2}^{-1} \cdots g_i^{-1}) + \\
& + \sum_{k=1}^{i-1} q^{i-(k+1)}(q-1)^2(t^\nu t_i' - t^\nu t_k')(g_k \cdots g_1^2 \cdots g_k) + q^{i-1}(q^2 - q + 1)(t_i'^{\nu+1} - t^\nu t_i') + \\
& + \sum_{k=1}^{i-1} q^{i-(k+1)}(q-1)(t_k'^{\nu} - t^\nu) \underline{(g_i \cdots g_{k+1} g_{k+2}^{-1} \cdots g_i^{-1}) t_i'} (g_k \cdots g_1^2 \cdots + g_k) + \\
& + \sum_{k=1}^{i-1} q^{i-(k+1)}(q-1)^2(t_i'^{\nu} - t_k'^{\nu}) t_i' (g_k \cdots g_1^2 \cdots g_k) = \\
& = t^{\nu+1}(g_i \cdots g_1^2 \cdots g_i) + q^{i-1}(q^2 - q + 1)(t_i'^{\nu+1} - t^{\nu+1}) + \sum_{k=1}^{i-1} q^{i-(k+1)}(q-1)^2 t^\nu t_i' - t^\nu t_k' + \\
& + t_i'^{\nu+1} - t_k'^{\nu} t_i' (g_k \cdots g_1^2 \cdots g_k) + \sum_{k=1}^{i-1} q^{i-(k+1)}(q-1)(t^\nu t_k' - t^{\nu+1})(g_i \cdots g_1^2 \cdots g_k g_{k+2}^{-1} \cdots g_i^{-1}) + \\
& + \sum_{k=1}^{i-1} q^{i-(k+1)}(q-1)(t_k'^{\nu} - t^\nu) ((q-1)t_i' + q t_k' (g_i \cdots g_{k+2} g_{k+1}^{-1} \cdots g_i^{-1})) (g_k \cdots g_1^2 \cdots g_k) = \\
& = t^{\nu+1}(g_i \cdots g_1^2 \cdots g_i) + q^{i-1}(q^2 - q + 1)(t_i'^{\nu+1} - t^{\nu+1}) + \\
& \sum_{k=1}^{i-1} q^{i-(k+1)}(q-1)^2(t^\nu t_i' - t^\nu t_k' + t_i'^{\nu+1} - t_k'^{\nu} t_i')(g_k \cdots g_1^2 \cdots g_k) + \\
& + \sum_{k=1}^{i-1} q^{i-(k+1)}(q-1)(t^\nu t_k' - t^{\nu+1})(g_i \cdots g_1^2 \cdots g_k g_{k+2}^{-1} \cdots g_i^{-1}) + \\
& + \sum_{k=1}^{i-1} q^{i-(k+1)}(q-1)^2(t_k'^{\nu} t_i' - t^\nu t_i')(g_k \cdots g_1^2 \cdots g_k) + \\
& + \sum_{k=1}^{i-1} q^{i-(k+1)}(q-1)q(t_k'^{\nu+1} - t^\nu t_k')(g_i \cdots g_{k+2} g_{k+1}^{-1} \cdots g_i^{-1})(g_k \cdots g_1^2 \cdots g_k) = \\
& = t^{\nu+1}(g_i \cdots g_1^2 \cdots g_i) + q^{i-1}(q^2 - q + 1)(t_i'^{\nu+1} - t^{\nu+1}) + \\
& + \sum_{k=1}^{i-1} q^{i-(k+1)}(q-1)^2(t_i'^{\nu+1} - t^\nu t_k')(g_k \cdots g_1^2 \cdots g_k) +
\end{aligned}$$

$$\begin{aligned}
& + \sum_{k=1}^{i-1} q^{i-(k+1)} (q-1) (t^\nu t'_k - t^{\nu+1}) (g_i \dots g_1^2 \dots g_k g_{k+2}^{-1} \dots g_i^{-1}) + \\
& + \sum_{k=1}^{i-1} q^{i-(k+1)} (q-1) (t_k^{\nu+1} - t^\nu t'_k) (g_i \dots g_1^2 \dots g_k g_{k+2}^{-1} \dots g_i^{-1}) + \\
& + \sum_{k=1}^{i-1} q^{i-(k+1)} (q-1)^2 (t_k^{\nu+1} - t^\nu t'_k) (g_k \dots g_1^2 \dots g_k) = \\
& = t^{\nu+1} (g_i \dots g_1^2 \dots g_i) + q^{i-1} (q^2 - q + 1) (t_i^{\nu+1} - t^{\nu+1}) + \\
& + \sum_{k=1}^{i-1} q^{i-(k+1)} (q-1)^2 (t_i^{\nu+1} - t_k^{\nu+1}) (g_k \dots g_1^2 \dots g_k) + \\
& + \sum_{k=1}^{i-1} q^{i-(k+1)} (q-1) (t_k^{\nu+1} - t^\nu t^{\nu+1}) (g_i \dots g_1^2 \dots g_k g_{k+2}^{-1} \dots g_i^{-1}). \quad \square
\end{aligned}$$

Lemma 3.22. *The following relations hold in $H_{1,n}(q)$:*

$$\begin{aligned}
(i) \quad t'_i t'_j &= t'_j t'_i + (1 - q^{-1}) t'_j t'_i (g_i \dots g_{j+1} g_{j+2}^{-1} \dots g_i^{-1}) + \\
& + (q^{-1} - 1) t_i'^2 (g_i \dots g_{j+1} g_{j+2}^{-1} \dots g_i^{-1}) \\
(ii) \quad t_i^k t_j^\lambda &= t_j^\lambda t_i^k + \\
& + (1 - q^{-1}) \sum_{m=1}^{\lambda} t_j^{k+\lambda-m} t_i^m (g_i \dots g_{j+1} g_{j+2}^{-1} \dots g_i^{-1}) + \\
& + (q^{-1} - 1) \sum_{m=1}^{\lambda} t_j^{\lambda-m} t_i^{k+m} (g_i \dots g_{j+1} g_{j+2}^{-1} \dots g_i^{-1})
\end{aligned}$$

Proof. We only prove relation (i). Relation (ii) follows similarly.

$$\begin{aligned}
t'_i t'_j &= g_i \dots g_1 t g_1^{-1} \dots g_i^{-1} g_j \dots g_1 t g_1^{-1} \dots g_j^{-1} = \\
& g_i \dots g_1 t g_1^{-1} \dots g_j^{-1} g_{j+1} g_{j+2}^{-1} \dots g_i^{-1} g_j \dots g_1 t g_1^{-1} \dots g_j^{-1} = \\
& g_i \dots g_1 t g_1^{-1} \dots g_j^{-1} g_{j+1} g_j \dots g_1 t g_1^{-1} \dots g_j^{-1} g_{j+2} \dots g_i^{-1} = \\
& g_i \dots g_1 t (g_{j+1} \dots g_2 g_1^{-1} g_2^{-1} \dots g_{j+1}^{-1}) t g_1^{-1} \dots g_j^{-1} g_{j+2} \dots g_i^{-1} = \\
& g_i g_{i-1} \dots g_{j+1} (g_j g_{j-1} \dots g_1 t g_{j+1} g_j \dots g_2) g_1^{-1} (g_2^{-1} \dots g_{j+1}^{-1} t g_1^{-1} \dots g_j^{-1}) g_{j+2}^{-1} \dots g_i^{-1} = \\
& (g_i g_{i-1} \dots g_{j+2}) (g_{j+1} g_j g_{j+1}) (g_{j-1} g_j) \dots (g_2 g_3) (g_1 g_2) t g_1^{-1} t (g_2^{-1} g_1^{-1}) \dots (g_{j+1}^{-1} g_j^{-1}) (g_{j+2}^{-1} \dots g_i^{-1}) = \\
& (g_i \dots g_{j+2}) (g_j g_{j+1}) (g_j g_{j-1} g_j) \dots (g_1 g_2) t g_1^{-1} t (g_2^{-1} g_1^{-1}) \dots (g_{j+1}^{-1} g_j^{-1}) (g_{j+2}^{-1} \dots g_i^{-1}) = \\
& (g_i \dots g_{j+2}) (g_j g_{j+1}) \dots (g_2 g_3) (g_2 g_1 g_2) t g_1^{-1} t (g_2^{-1} g_1^{-1}) \dots (g_{j+1}^{-1} g_j^{-1}) (g_{j+2}^{-1} \dots g_i^{-1}) = \\
& (g_i \dots g_{j+2}) (g_j g_{j+1}) \dots (g_2 g_3) (g_1 g_2) (g_1 t g_1^{-1} t) (g_2^{-1} g_1^{-1}) \dots (g_{j+1}^{-1} g_j^{-1}) (g_{j+2}^{-1} \dots g_i^{-1}) = \\
& (g_i \dots g_{j+2}) (g_j g_{j+1}) \dots (g_2 g_3) (g_1 g_2) (t g_1 t g_1^{-1} + (1 - q^{-1}) t g_1 t + (q^{-1} - 1) g_1 t^2) (g_2^{-1} g_1^{-1}) \dots \\
& (g_{j+1}^{-1} g_j^{-1}) (g_{j+2}^{-1} \dots g_i^{-1}) = \\
& \underbrace{(g_i \dots g_{j+2}) (g_j g_{j+1}) \dots (g_2 g_3) (g_1 g_2) t g_1 t g_1^{-1} (g_2^{-1} g_1^{-1}) \dots (g_{j+1}^{-1} g_j^{-1}) (g_{j+2}^{-1} \dots g_i^{-1})}_{A} + \\
& \underbrace{(1 - q^{-1}) (g_i \dots g_{j+2}) (g_j g_{j+1}) \dots (g_2 g_3) (g_1 g_2) t g_1 t (g_2^{-1} g_1^{-1}) \dots (g_{j+1}^{-1} g_j^{-1}) (g_{j+2}^{-1} \dots g_i^{-1})}_{B} + \\
& \underbrace{(q^{-1} - 1) (g_i \dots g_{j+2}) (g_j g_{j+1}) \dots (g_2 g_3) (g_1 g_2 g_1) t^2 (g_2^{-1} g_1^{-1}) \dots (g_{j+1}^{-1} g_j^{-1}) (g_{j+2}^{-1} \dots g_i^{-1})}_{C}.
\end{aligned}$$

$$\begin{aligned}
A &= g_j \dots g_1 t g_i \dots g_j \dots g_1 t (g_1^{-1} g_2^{-1}) g_1^{-1} (g_3^{-1} g_2^{-1}) \dots (g_{j+1}^{-1} g_j^{-1}) (g_{j+2}^{-1} \dots g_i^{-1}) = \\
& g_j \dots g_1 t g_i \dots g_j \dots g_1 t g_2^{-1} g_1^{-1} (g_2^{-1} g_3^{-1} g_2^{-1}) \dots (g_{j+1}^{-1} g_j^{-1}) (g_{j+2}^{-1} \dots g_i^{-1}) = \\
& g_j \dots g_1 t g_i \dots g_j \dots g_1 g_2^{-1} t g_1^{-1} g_3^{-1} g_2^{-1} (g_3^{-1} g_4^{-1} g_3^{-1}) \dots (g_{j+1}^{-1} g_j^{-1}) (g_{j+2}^{-1} \dots g_i^{-1}) =
\end{aligned}$$

$$g_j \cdots g_1 t g_i \cdots g_{j+1} \cdots g_1 g_2^{-1} \cdots g_{j+1}^{-1} t g_1^{-1} \cdots g_i^{-1} =$$

$$g_j \cdots g_1 t (g_i \cdots g_{j+2}) (g_1^{-1} \cdots g_j^{-1}) (g_i \cdots g_1 t g_1^{-1} \cdots g_i^{-1}) = t'_j t'_i$$

$$B = (1 - q^{-1}) (g_j \cdots g_1) t (g_i \cdots g_1 g_2^{-1} \cdots g_i^{-1}) t (g_1^{-1} \cdots g_j^{-1}) =$$

$$(1 - q^{-1}) (g_j \cdots g_1) t (g_1^{-1} \cdots g_{i-1}^{-1} g_i g_{i-1} \cdots g_1) t (g_1^{-1} \cdots g_j^{-1}) =$$

$$(1 - q^{-1}) t'_j (g_{j+1}^{-1} \cdots g_{i-1}^{-1} g_i g_{i-1} \cdots g_1 t g_1^{-1} \cdots g_j^{-1}) =$$

$$(1 - q^{-1}) t'_j (g_{j+1}^{-1} \cdots g_{i-1}^{-1} g_i g_{i-1} \cdots g_{j+1}) g_j \cdots g_1 t g_1^{-1} \cdots g_j^{-1} =$$

$$(1 - q^{-1}) t'_j g_i \cdots g_{j+1} (g_{j+2}^{-1} \cdots g_i^{-1}) g_j \cdots g_1 t g_1^{-1} \cdots g_j^{-1} =$$

$$(1 - q^{-1}) t'_j g_i \cdots g_{j+1} \cdots g_1 t g_1^{-1} \cdots g_j^{-1} g_{j+2}^{-1} \cdots g_i^{-1} =$$

$$(1 - q^{-1}) t'_j t'_i g_i \cdots g_{j+1} g_{j+2}^{-1} \cdots g_i^{-1}$$

$$C = (q^{-1} - 1) (g_j \cdots g_1) (g_i \cdots g_1 g_2^{-1} \cdots g_i^{-1}) t^2 g_1^{-1} \cdots g_j^{-1} =$$

$$(q^{-1} - 1) (g_j \cdots g_1) (g_1^{-1} \cdots g_{i-1}^{-1} g_i g_{i-1} \cdots g_1) t^2 g_1^{-1} \cdots g_j^{-1} =$$

$$(q^{-1} - 1) g_{i-1}^{-1} g_i g_{i-1} \cdots g_1 t^2 g_1^{-1} \cdots g_j^{-1} =$$

$$(q^{-1} - 1) g_i g_{i-1} g_{i-1}^{-1} g_{i-2} \cdots g_1 t^2 g_1^{-1} \cdots g_j^{-1} =$$

$$(q^{-1} - 1) g_i g_{i-1} \cdots g_1 t^2 g_1^{-1} \cdots g_j^{-1} g_i^{-1} =$$

$$(q^{-1} - 1) t_i'^2 (g_i g_{i-1} \cdots g_{j+1} g_{j+2}^{-1} \cdots g_i^{-1}).$$

□

Using the lemmas above we have the following relations in $H_{1,n}(q)$:

$$(iii) \quad t_i^2 = t'_i t (g_i \cdots g_1^2 \cdots g_i) +$$

$$+ q^{i-1} (q^2 - q + 1) (t_i'^2 - t'_i t) (g_i \cdots g_1^2 \cdots g_i) +$$

$$+ \sum_{k=1}^{i-1} q^{i-(k+1)} (q - 1) (t'_i t'_k - t'_i t) (g_i \cdots g_{k+2}^{-1} \cdots g_i^{-1}) \cdot$$

$$(g_k \cdots g_1^2 \cdots g_k) (g_i \cdots g_1^2 \cdots g_i) +$$

$$+ \sum_{k=1}^{i-1} q^{i-(k+1)} (q - 1)^2 (t_i'^2 - t'_i t'_k) (g_k \cdots g_1^2 \cdots g_k) \cdot$$

$$(g_i \cdots g_{k+2}^{-1} \cdots g_i^{-1})$$

THE HOMFLYPT SKEIN MODULE OF THE LENS SPACES $L(P, 1)$ VIA BRAIDS

In this chapter we propose a new method for computing skein modules of 3-manifolds via braids and we demonstrate this approach in the case of the Homflypt skein module of $L(p, 1)$, $S(L(p, 1))$. The computation of $S(L(p, 1))$ is equivalent to constructing all possible analogues of the Homflypt or 2-variable Jones polynomial for knots and links in $L(p, 1)$, since the linear dimension of $S(L(p, 1))$ means the number of independent Homflypt-type invariants defined on knots and links in $L(p, 1)$. In [GM14] a basis for $S(L(p, 1))$ is presented using diagrammatic methods. The diagrammatic approach could in theory be generalized to the case of arbitrary c.c.o. 3-manifolds, but the diagrams become more cumbersome to analyze and several induction arguments fail. The advantage of the braid approach is that it gives more control over the band moves than the diagrammatic approach and much of the diagrammatic complexity is absorbed into the proofs of the algebraic statements. We only need to consider one type of orientations patterns and the braid band moves are limited.

The importance of our approach is that it can shed light to the problem of computing skein modules of arbitrary c.c.o. 3-manifolds, since any c.c.o. 3-manifold can be obtained by surgery on S^3 along unknotted closed curves. Indeed, one can use our results on $S(L(p, 1))$ and our results of braid equivalence in arbitrary c.c.o. 3-manifolds (Chapter 2, [DL13]) in order to apply a braid approach to the skein module of an arbitrary c.c.o. 3-manifold. The braid approach is based on the knowledge of the Homflypt skein module of the solid torus ST [HK90, Tur88, Lam99, DL15]. The main difficulty of the problem lies in selecting from the infinitum of band moves (or handle slide moves) some basic ones, solving the infinite system of equations and proving that there are no dependencies in the solutions. It may be worth adding that the Kauffman bracket skein module of the lens spaces $L(p, q)$, any q , is far easier to compute and has been done long ago by J. H. Przytycki and J. Hoste [HP93, HP95]. Finally, it is worth mentioning that knowledge of the skein modules of a 3-manifold renders topological information about the 3-manifold.

4.1 Introduction

The Lambropoulou invariant X (recall Theorem 1.10) for knots and links in ST recovers the Homflypt skein module of ST since it gives different values for different elements of Λ' by rule 4 of the trace (recall Theorem 1.9). This invariant is appropriate for computing the Homflypt skein module of $L(p, 1)$. Indeed, we first show that a braid band move may always be assumed to take place on the first moving strand of a mixed braid in $B_{1,n}$. Then, we show that it suffices to consider braid band moves performed on elements in the linear basis Σ'_n of the algebra $H_{1,n}(q)$, and this is the first step in order to restrict the performance of braid band moves only on elements in an expanded set L (see Notation 4.1). Note that the expanded set L has the basis of $S(\text{ST})$, $\Lambda := \bigcup_n \Lambda_{(n)}$, as a proper subset, and elements in Λ describe the braid band moves naturally. In fact, this important property of the set Λ reflects the initial motivation behind the results presented in Chapter 3. Then, using the technique of cabling, we show that it suffices to consider elements in the basis Σ_n . Note that elements in Σ_n may have gaps in the indices of the looping generators t_i . So, for $T \cdot w \in \Sigma_n$, where T is a monomial of the t_i 's and $w \in H_n(q)$, we obtain the following equations:

$$X_{\widehat{T \cdot w}} = \begin{cases} X_{t^p T_+ \cdot w_+ \cdot \sigma_1} \\ X_{t^p T_+ \cdot w_+ \cdot \sigma_1^{-1}} \end{cases} \quad (\diamond)$$

Finally, we show that equations of type (\diamond) reduce to equations of the same type with $T \in \Lambda$, but with the performance of braid band move on any moving strand of $T \cdot w$. Then, we show that these equations are equivalent to equations obtained from elements τ in L , where the performance of the braid band move is only taking place on the first moving strand of τ . Namely, we show the following:

$$X_{\widehat{T}} = X_{t^p T_+ \cdot \sigma_j \sigma_{j-1} \dots \widehat{\sigma_1^{\pm 1} \sigma_2^{-1} \dots \sigma_j^{-1}}} \Leftrightarrow \sum_i \left(X_{\widehat{\tau_i}} = X_{t^p \tau_{i+} \cdot \sigma_1^{\pm 1}} \right),$$

where the braid band move on $T \in \Lambda_k \subset \Lambda$ is performed on the j^{th} -moving strand and $\tau_i \in L$ such that $\tau_i \leq T$, $\forall i$.

We work towards solving an infinite system of equations coming from the braid band moves, by showing first that the system splits into infinite self-contained subsystems. We then present some combinatorial results in order to show that each subsystem admits unique solution and translate this difficult problem to a simple conjecture, a solution of which leads to the following basis for $S(L(p, 1))$:

$$B_{p,1} = \{t^{k_0} \dots t^{k_n} : p-1 \geq k_0 \geq \dots \geq k_n \geq 0, k_i \in \mathbb{Z}^* \forall i\}.$$

4.2 Topological steps towards $S(L(p, 1))$

In [LR06, DL15] the braid band move (denoted by bbm) is defined from the last strand. We show that this is equivalent to performing a bbm on the first moving strand of a

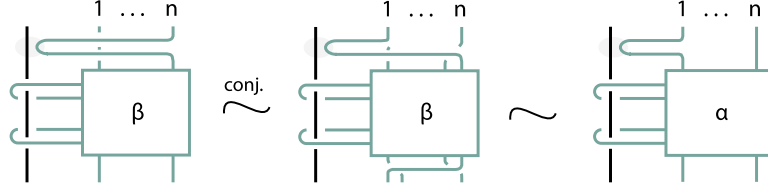

Fig. 4.1: Proof of Lemma 4.1.

mixed braid in $B_{1,n}$. We denote the result of a positive or negative braid band move performed on the i^{th} -moving strand of a mixed link β by $sl_{\pm i}(\beta)$.

Lemma 4.1. *A braid band move may always be assumed to be performed on the first moving strand of a mixed braid.*

Proof. In a mixed braid $B \cup \beta$ consider the last strand of β approaching the surgery strand B from the right. Before performing a bbm we apply conjugation (isotopy in ST) and obtain an equivalent mixed braid where the first strand is now approaching B . In terms of diagrams we have the following:

$$\begin{array}{ccc}
 \beta & \sim & (\sigma_{i-1} \dots \sigma_1 \sigma_1^{-1} \dots \sigma_{i-1}^{-1}) \cdot \beta \sim \underbrace{(\sigma_1^{-1} \dots \sigma_{i-1}^{-1}) \cdot \beta \cdot (\sigma_{i-1} \dots \sigma_1)}_{\alpha} = \alpha \\
 \downarrow & & \downarrow \\
 sl_{\pm i}(\beta) & & sl_{\pm 1}(\alpha)
 \end{array}$$

□

Our method for computing $S(L(p, 1))$ is the following:

1. We start with diagrams in ST and perform bbm's on the first strand and we reduce to working with elements in Σ'_n .
2. We impose on the Lambropoulou invariant X for knots and links in ST the relations $X_{\hat{\alpha}} = X_{\widehat{sl_{\pm 1}(\alpha)}}$ and obtain an infinite system.
3. We show that the equations obtained only from elements in the basis Λ of $S(\text{ST})$, but with the bbm performed on any strand, suffice to compute $S(L(p, 1))$.
4. We then show that the equations obtained from elements in an expanded set L , where the bbm is only performed on the first strand, are equivalent to the equations described in step 3.
5. We finally work towards the solution of the system, which is equivalent to computing $S(L(p, 1))$.

4.2.1 From diagrams in ST to elements in Σ'_n

In this paragraph we show that it suffices to perform bbm 's on elements in the linear basis of $H_{1,n}(q)$, Σ'_n . This is the first step in order to restrict the performance of bbm 's only on elements in Λ . For this we need the following lemma:

Lemma 4.2. *Braid band moves and skein relation are interchangeable, that is, for $w \in H_n(q)$ the following diagram commutes:*

$$\begin{array}{ccc} \tau'_1 \cdot w & \xrightarrow{(\pm)(p,1)\text{bbm}} & \tau'_2 \cdot w_+ g_1^{\pm 1} \\ \downarrow \text{quadratic} & & \downarrow \text{quadratic} \\ \sum_j f_j(q) \tau'_1 \cdot w_j & \xrightarrow{(\pm)(p,1)\text{bbm}} & \sum_j f_j(q) \tau'_2 \cdot w_{j+} g_1^{\pm 1} \end{array}$$

Proof. Let τ'_1 a monomial in t'_i 's, $w \in H_n(q)$ such that $w = \sum_{i=1}^n f_i(q) w_i$, where w_i are words in canonical form and $f_i(q)$ a one parameter expressions in \mathbb{C} for all i . We perform a braid band move on $\tau'_1 \cdot w$ and obtain:

$$\tau'_1 \cdot w \xrightarrow[\text{bbm}]{(\pm)(p,1)} \tau'_2 \cdot w_+ g_1^{\pm 1},$$

where $w_+ = \sum_{i=1}^n f_i(q) w_{i+}$. Then:

$$\tau'_1 \cdot w = \tau'_1 \cdot \sum_{i=1}^n f_i(q) w_i \xrightarrow[\text{bbm}]{(\pm)(p,1)} \tau'_2 \cdot \sum_{i=1}^n f_i(q) w_{i+} g_1^{\pm 1}.$$

We also have that:

$$\tau'_1 \cdot w_j \xrightarrow[\text{bbm}]{(\pm)(p,1)} \tau'_2 \cdot w_{j+} g_1^{\pm 1} \quad \forall j, \text{ and thus}$$

$$\tau'_2 \cdot \sum_{i=1}^n f_i(q) w_i g_1^{\pm 1} = \tau'_2 \cdot w_+ g_1^{\pm 1},$$

and this concludes the proof. \square

Proposition 4.1. *It suffices to consider the performance of braid band moves only on elements in the linear basis Σ'_n .*

Proof. By Artin's combing we can write words in $B_{1,n}$ in the form $\tau' \cdot w$, where τ' is a monomial in t'_i 's and $w \in B_n$. By Lemma 4.2 we have that:

$$\begin{aligned} X_{\widehat{\tau' \cdot w}} &= X_{\widehat{t^p \tau'' \cdot g_1^{\pm 1} \cdot w_+}} \xrightarrow{\text{quad.rel.}} \\ \sum_i A_i \cdot X_{\widehat{\tau' \cdot w_i}} &= \sum_i A_i \cdot X_{\widehat{t^p \tau'' \cdot g_1^{\pm 1} \cdot w_{i+}}}, \end{aligned}$$

where w_i are words in reduced form in $H_{1,n}(q)$, $\forall i$ and $A_i \in \mathcal{R}$. \square

4.2.2 From the set Σ'_n to the set Σ_n

In this paragraph we show that it suffices to perform bbm's on elements in the linear bases of the algebra $H_{1,n}(q)$, Σ_n , which include $\Lambda_{(n)}$ as a proper subset.

Let $\tau' \cdot w \in \Sigma'_n$. We have that:

$$\begin{aligned} \tau' \cdot w &= (t^{k_0} t_1^{k_1} \dots t_m^{k_m}) \cdot w = \underbrace{t^{k_0} (t_1 g_1^{-2})^{k_1} \dots (t_m g_m^{-1} \dots g_2^{-1} g_1^{-2} g_2^{-1} \dots g_m^{-1})^{k_m}}_{\tau} \cdot w = \\ &= \tau \cdot w \end{aligned}$$

Perform a bbm on the first moving strand of both $\tau' \cdot w$ and $\tau \cdot w$ and cable the new parallel strand together with the surgery strand. Denote the result as $cbl(ps)$. Then:

$$\begin{array}{ccc} \tau' \cdot w & \xrightarrow{bbm} & cbl(ps) \cdot \tau' \cdot w \cdot \sigma_1^{\pm 1} \\ \parallel & & \parallel \\ \tau \cdot w & \xrightarrow{bbm} & cbl(ps) \cdot \tau \cdot w \cdot \sigma_1^{\pm 1} \end{array}$$

So: $X_{\widehat{\tau' \cdot w}} = X_{\widehat{sl(\tau' \cdot w)}} \Leftrightarrow X_{\widehat{\tau \cdot w}} = X_{\widehat{sl(\tau \cdot w)}}$. But since $\tau \cdot w \in H_{1,n}(q)$, we can express $\tau \cdot w$ as a sum of elements in the linear basis of $H_{1,n}(q)$, Σ_n , that is $\tau \cdot w = \sum_i a_i T_i \cdot w_i$, where $T_i \cdot w_i \in \Sigma$, $\forall i$, T_i a monomial in t_i 's with possible gaps in the indices and unordered exponents, and $a_i \in \mathbb{C}$, $\forall i$.

$$\begin{aligned} X_{\widehat{\tau \cdot w}} = X_{\widehat{sl(\tau \cdot w)}} &\Rightarrow \alpha \cdot tr(\tau \cdot w) = b \cdot tr(cbl(ps) \tau \cdot w \cdot g_1^{\pm 1}) \\ &\Rightarrow \alpha \cdot \sum_i a_i \cdot tr(T_i \cdot w_i) = b \cdot \sum_i tr(a_i \cdot cbl(ps) T_i \cdot w_i \cdot g_1^{\pm 1}) \end{aligned}$$

We conclude that:

$$\begin{array}{ccc} \tau' \cdot w & \xrightarrow{bbm} & cbl(ps) \cdot \tau' \cdot w \cdot \sigma_1^{\pm 1} \quad (*) \\ \parallel & & \parallel \\ \tau \cdot w & \xrightarrow{bbm} & cbl(ps) \cdot \tau \cdot w \cdot \sigma_1^{\pm 1} \\ \parallel & & \parallel \\ \sum_i a_i \cdot T_i \cdot w_i & \xrightarrow{bbm} & \sum_i a_i \cdot t^p T_{i+} \cdot w_{i+} g_1^{\pm 1} \quad (**) \end{array}$$

The above are summarized in the following proposition:

Proposition 4.2. *The equations $X_{\widehat{T' \cdot w}} = X_{\widehat{t^p T' \cdot g_1^{\pm 1} \cdot w_+}}$ result from equations of the form $X_{\widehat{T \cdot w}} = X_{\widehat{t^p T \cdot g_1^{\pm 1} \cdot w_+}}$, where $T \cdot w \in \Sigma_n$, $\forall i$.*

Elements in Σ_n consist of two parts:

- A monomial in t_i 's with possible gaps in the indices and unordered exponents, followed by
- a braiding “tail” in the basis of $H_n(q)$.

In order to prove that the system obtained from elements in Σ_n is equivalent to the system obtained from elements in $\Lambda_{(n)}$, we first manage the gaps in the indices in the monomials in t_i 's, we then order the exponents and finally we eliminate the tails. The procedure is similar to the one described in Chapter 2, but in this case we do that simultaneously before and after the performance of a braid band move and show that the equations obtained from elements in the sets Σ_n and $\Lambda_{(n)}$ are equivalent.

4.2.3 From Σ_n to the $H_n(q)$ -module $\Lambda_{(n)}$: managing the gaps and ordering the exponents

In order to restrict the bbm's only on elements in Λ we need first to introduce the expanded set L :

Notation 4.1. We denote by $L_{(n)}$, the set:

$$L_{(n)} := \{t^{k_0}t_1^{k_1} \dots t_n^{k_n}, k_i \in \mathbb{Z}^*\},$$

$L := \bigcup_n L_{(n)}$, and the subset of level k , L_k , of L :

$$L_k := \{t^{k_0}t_1^{k_1} \dots t_m^{k_m} \mid \sum_{i=0}^m k_i = k, k_i \in \mathbb{Z}^*\}.$$

We now show that equations of type (**) reduce to equations of the same type, but from elements in the set Λ (i.e. no gaps in the indices). We will need the following lemma:

Lemma 4.3. *The equations $X_{\widehat{t_1^k}} = X_{\widehat{t^p t_2^k \sigma_1^{\pm 1}}}$ are equivalent to the equations*

$$\begin{aligned} X_{\widehat{t^{u_0} t_1^{u_1}}} &= X_{\widehat{t^p t_1^{u_0} t_2^{u_1} \sigma_1^{\pm 1}}}, \quad \forall u_0, u_1 < k : u_0 + u_1 = k, \\ X_{\widehat{t^k}} &= X_{\widehat{t^p t_1^k \sigma_1^{\pm 1}}}, \\ X_{\widehat{t^k}} &= X_{\widehat{t^p t_1^k \sigma_2^{\pm 1} \sigma_1^{-1}}}. \end{aligned}$$

Proof. We have that:

$$\begin{aligned} t_1^k &= \underline{t_1^{k-1} \sigma_1 t \sigma_1} = (q-1) \sum_{j=0}^{k-2} q^j t^{j+1} t_1^{k-1-j} \sigma_1 + q^{k-1} \underline{\sigma_1 t^k \sigma_1} \\ \downarrow & \\ t^p t_2^k \sigma_1^{\pm 1} &= \underline{t^p t_2^{k-1} \sigma_2 t_1 \sigma_2 \sigma_1^{\pm 1}} = (q-1) \sum_{j=0}^{k-2} q^j t^p t_1^{j+1} t_2^{k-1-j} \sigma_2 \sigma_1^{\pm 1} + q^{k-1} t^p \underline{\sigma_2 t_1^k \sigma_2 \sigma_1^{\pm 1}} \end{aligned}$$

Now,

$$\begin{aligned} q^{k-1} \underline{\sigma_1 t^k \sigma_1} &\hat{=} q^{k-1} t^k \sigma_1^2 \stackrel{\text{skein}}{=} q^{k-1} (q-1) t^k \sigma_1 + q^k t^k \\ q^{k-1} t^p \underline{\sigma_2 t_1^k \sigma_2 \sigma_1^{\pm 1}} &\hat{=} q^{k-1} t^p t_1^k \sigma_2 \sigma_1^{\pm 1} \underline{\sigma_2} \stackrel{\text{skein}}{=} q^k t^p t_1^k \sigma_2 \sigma_1^{\pm 1} \sigma_2^{-1} + q^{k-1} (q-1) t^p t_1^k \sigma_2 \sigma_1^{\pm 1} \end{aligned}$$

and by applying a stabilization move we have:

$$\begin{aligned} q^{k-1}(q-1)t^k\sigma_1 + q^k t^k &\simeq q^{k-1}(q-1)z t^k + q^k t^k \\ q^k t^p t_1^k \sigma_2 \sigma_1^{\pm 1} \sigma_2^{-1} + q^{k-1}(q-1)t^p t_1^k \sigma_2 \sigma_1^{\pm 1} &\simeq q^{k-1}(q-1)z t^p t_1^k \sigma_1^{\pm 1} + q^k t^p t_1^k \sigma_2 \sigma_1^{\pm 1} \sigma_2^{-1} \end{aligned}$$

Moreover,

$$\begin{aligned} (q-1) \sum_{j=0}^{k-2} q^j t^{j+1} \underline{t_1^{k-1-j} \sigma_1} &= \\ = (q-1) \sum_{j=0}^{k-2} q^j t^{j+1} \cdot \left[(q-1) \sum_{\phi=0}^{k-2-j} q^\phi t^\phi t_1^{k-1-j-\phi} + q^{k-1-j} \sigma_1 t^{k-1-j} \right] &= \\ = (q-1)^2 \sum_{j=0}^{k-2} \sum_{\phi=0}^{k-2-j} q^{j+\phi} t^{j+1+\phi} t_1^{k-1-j-\phi} + (q-1) \sum_{j=0}^{k-2} q^{k-1} t^{j+1} \underline{t \sigma_1} t^{k-1-j} &\simeq \\ \simeq (q-1)^2 \sum_{j=0}^{k-2} \sum_{\phi=0}^{k-2-j} q^{j+\phi} t^{j+1+\phi} t_1^{k-1-j-\phi} + (q-1)(k-1) q^{k-1} z t^k, \end{aligned}$$

and

$$\begin{aligned} (q-1) \sum_{j=0}^{k-2} q^j t^p t_1^{j+1} \underline{t_2^{k-1-j} \sigma_2 \sigma_1^{\pm 1}} &= \\ = (q-1) \sum_{j=0}^{k-2} q^j t^p t_1^{j+1} \cdot \left[(q-1) \sum_{\phi=0}^{k-2-j} q^\phi t_1^\phi t_2^{k-1-j-\phi} + q^{k-1-j} \sigma_2 t_1^{k-1-j} \right] \sigma_1^{\pm 1} &= \\ = (q-1)^2 \sum_{j=0}^{k-2} \sum_{\phi=0}^{k-2-j} q^{j+\phi} t^p t_1^{j+1+\phi} t_2^{k-1-\phi} \sigma_1^{\pm 1} + (q-1) \sum_{j=0}^{k-2} q^{k-1} t^p t_1^{j+1} \underline{t \sigma_2} t_1^{k-1-j} \sigma_1^{\pm 1} &\simeq \\ \simeq (q-1)^2 \sum_{j=0}^{k-2} \sum_{\phi=0}^{k-2-j} q^{j+\phi} t^p t_1^{j+1+\phi} t_2^{k-1-j-\phi} \sigma_1^{\pm 1} + (q-1)(k-1) q^{k-1} z t^p t_1^k \sigma_1^{\pm 1}. \end{aligned}$$

So we have the following:

t_1^k	$\xrightarrow{\text{bbm } 1^{st}\text{-str.}}$	$t^p t_2^k \sigma_1^{\pm 1}$
\simeq		\simeq
$(q-1)^2 \sum_{j=0}^{k-2} \sum_{\phi=0}^{k-2-j} q^{j+\phi} t^{j+1+\phi} t_1^{k-1-j-\phi}$	$\xrightarrow{\text{bbm } 1^{st}\text{-str.}}$	$(q-1)^2 \sum_{j=0}^{k-2} \sum_{\phi=0}^{k-2-j} q^{j+\phi} t^{j+1+\phi} t_2^{k-1-j-\phi} \sigma_1^{\pm 1}$
$(q-1)(k-1) q^{k-1} z t^k$	$\xrightarrow{\text{bbm } 1^{st}\text{-str.}}$	$(q-1)(k-1) q^{k-1} z t^p t_1^k \sigma_1^{\pm 1}$
$(q-1) q^{k-1} z t^k$	$\xrightarrow{\text{bbm } 1^{st}\text{-str.}}$	$(q-1) q^{k-1} z t^p t_1^k \sigma_1^{\pm 1}$
$q^k t^k$	$\xrightarrow{\text{bbm } 2^{nd}\text{-str.}}$	$q^k z t^p t_1^k \sigma_2 \sigma_1^{\pm 1} \sigma_2^{-1}$

□

Proposition 4.3. *It suffices to consider monomials in $L_{(n)}$ followed by braiding tails in $H_n(q)$ and perform a braid band move on any strand, in order to obtain an equivalent infinite system to the one obtained from elements in Σ_n .*

Proof. Let τ_{gaps} a word containing gaps in the indices but not starting with one. We use Lemma 13 and 14 in [DL15]. The point is that when managing the gaps, the first part of the words (before the first gap) remains in tact after managing the gaps and the same carries through after the performance of a braid band move. That is, the following

diagram commutes:

$$\begin{array}{ccc}
\tau \cdot w & \xrightarrow[\text{bbm}]{1^{st} \text{ str.}} & t^p \tau_+ \cdot w_+ g_1^{\pm 1} \\
\downarrow & & \downarrow \\
\text{man.gaps} & & \text{man.gaps} \\
\downarrow & & \downarrow \\
\sum_i A_i \tau_i \cdot w_i & \xrightarrow[\text{bbm}]{1^{st} \text{ str.}} & \sum_i A_i t^p \tau_{i_+} \cdot w_{i_+} g_1^{\pm 1}
\end{array}$$

where $\tau \cdot w \in \Sigma_n$ and $\tau_i \in L$, $\forall i$.

In the case where the word $\tau \cdot w \in \Sigma_n$ starts with a gap, we show that equations obtained from $\tau \cdot w$ are equivalent to equations obtained from elements $\tau_i \cdot w_i \in \Sigma_n$, where τ_i are monomials in t_i 's not starting with a gap, but with the bbm performed on any strand. We prove this by induction on the strand m where the first gap occurs and the order of τ in Σ_n :

The case $m = 1$ is Lemma 4.3. Suppose that it holds for all elements where the first gap occurs on the m^{th} -strand. Let $\tau \cdot w = t_{m+1}^k \cdot \alpha$. Then, using Lemma 13 and 14 in [DL15], for $m + 1$ we have:

$$\begin{array}{ccc}
t_{m+1}^k \cdot \alpha & \xrightarrow[\text{bbm}]{1^{st} \text{ str.}} & t^p t_{m+2}^k \alpha_+ \sigma_1^{\pm 1} \\
\cong & & \cong \\
(q-1) \sum_{u=0}^{k-1} q^{u-1} t_m^u t_{m+1}^{k-u} \alpha \sigma_{m+1} & \xrightarrow[\text{bbm}]{1^{st} \text{ str.}} & (q-1) \sum_{u=0}^{k-1} q^{u-1} t^p t_{m+1}^u t_{m+2}^{k-u} \alpha_+ \sigma_{m+1} \sigma_1^{\pm 1} \\
q^{k-1} t_m^k \underline{\sigma_{m+1} \alpha \sigma_{m+1}} & \xrightarrow[\text{bbm}]{1^{st} \text{ str.}} & q^{k-1} t^p t_{m+1}^k \underline{\sigma_{m+2} \alpha_+ \sigma_{m+2} \sigma_1^{\pm 1}}
\end{array}$$

Interacting now on the left part the braiding generator σ_{m+1} with the looping generators in α , we obtain words in Σ_n where the first gap occurs on the m^{th} -moving strand. We follow the same procedure on the right part and the result follows by the induction hypothesis. \square

We also have the following more explicit formula:

Definition 4.1. (i) Let $t_i^k, i, k \in \mathbb{N}^*$. We call the corresponding maximum word of t_i^k , denoted by $cor(t_i^k)$, the word $tt_1 \dots t_{i-1} t_i^{k-i}$ if $k \geq i$, and $tt_1 \dots t_{k-1}$, if $k < i$.

(ii) We define $cor_m(t_i^k)$ to be the corresponding maximum word of t_i^k , where the first looping generator in $cor_m(t_i^k)$ is t_{m+1} .

(iii) We define the map f on arbitrary monomials in t_i 's to be $f(t_i^k \cdot t_j^\lambda) = f(t_i^k) \cdot f(t_j^\lambda)$, where $f(t_i^k) = cor(t_i^k)$ and $f(t_j^\lambda) = cor_m(t_j^\lambda)$, and m is the maximum index in $cor(t_i^k)$.

Let now $T \cdot w \in \Sigma_n$, where T is a monomial in t_i 's with possible gaps in the indices. We set as Λ_T all elements in Λ_k of less or equal order than the corresponding maximum word of T , $f(T) = \text{cor}(T)$. Then, the equation obtained from $T \cdot w$ by performing a bbm on the first strand is equivalent to equations obtained from elements in Λ_T by performing bbm's on any strand.

Example 4.1. Let $t_2^4 \cdot t_5^2 \in \Sigma_n$. The corresponding maximum word of $t_2^4 \cdot t_5^2$ is $f(t_2^4 \cdot t_5^2) = tt_1t_2^2t_3t_4$. Then,

$$\begin{aligned} X_{\widehat{t_2^4 \cdot t_5^2}} &= X_{t^p \cdot t_3^4 \cdot t_6^2 \cdot \sigma_1^{\pm 1}} \\ &\Leftrightarrow \\ \sum_i X_{\widehat{\tau_i}} &= \sum_{i,j} X_{t^p \cdot \tau_{i+1} \cdot (\sigma_j \dots \sigma_2 \sigma_1^{\pm 1} \sigma_2^{-1} \dots \sigma_j^{-1})}, \end{aligned}$$

where $\tau_i \in \Lambda_6 : \tau_i \leq tt_1t_2^2t_3t_4, \forall i$ and j the strand where the bbm is performed.

We now order the exponents and show that equations obtained from elements in the $H_n(q)$ -module $L_{(n)}$, reduce to equations obtained from elements in the $H_n(q)$ -module $\Lambda_{(n)}$.

Proposition 4.4. *Equations of the infinite system obtained from elements in $L_{(n)}$ followed by braiding tails in $H_{1,n}(q)$ are equivalent to equations obtained from elements in $\Lambda_{(n)}$ followed by braiding tails, where a braid band move can be performed on any moving strand.*

Proof. It follows from Theorem 9 in [DL15], since all steps followed so as to order the exponents in a monomial in t_i 's, remain the same after the performance of a bbm. \square

4.2.4 From the $H_n(q)$ -module $\Lambda_{(n)}$ to Λ_n : eliminating the tails

We now deal with the braiding tails and prove that equations obtained from elements in $\Lambda_{(n)}$ followed by words in $H_n(q)$ reduce to equations obtained from elements in $L_{(n)}$ by performing a bbm on any strand.

Proposition 4.5. *Equations of the infinite system obtained from elements in $\Lambda_{(n)}$ followed by words in $H_n(q)$ are equivalent to equations obtained from elements in $L_{(n)}$ by performing a braid band move on any moving strand.*

Proof. We perform a bbm and we cable the parallel strand with the surgery strand. We then apply Theorem 3.6 before and after the performance of the bbm and uncable the parallel strand. The proof is illustrated in Figure 4.2. \square

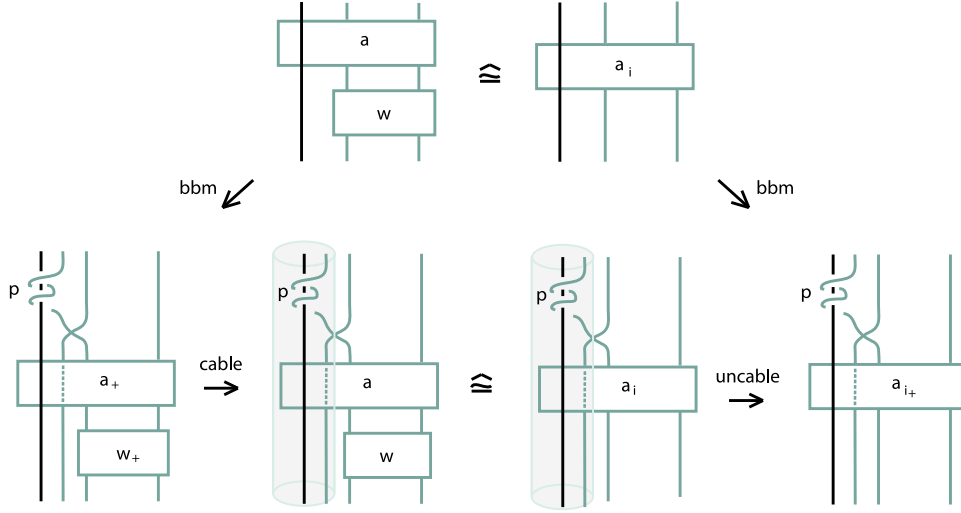

Fig. 4.2: Proof of Proposition 4.5.

Example 4.2.

$$\begin{array}{ccc}
tt_1t_2 \cdot g_1g_2g_1 & \xrightarrow[\text{bbm}]{1^{st} \text{ str.}} & t^pt_1t_2t_3 \cdot g_2g_3g_2g_1^{\pm 1} \\
\downarrow \text{el.tails} & & \downarrow \text{el.tails} \\
(q-1)(q^2-q+1)tt_1t_2 & \xrightarrow[\text{bbm}]{1^{st} \text{ str.}} & (q-1)(q^2-q+1)t^pt_1t_2t_3g_1^{\pm 1} \\
+ & & + \\
q(q-1)^2ztt_1^2 & \xrightarrow[\text{bbm}]{1^{st} \text{ str.}} & q(q-1)^2zt^pt_1t_2^2g_1^{\pm 1} \\
+ & & + \\
a \cdot t^2t_1 & \xrightarrow[\text{bbm}]{1^{st} \text{ str.}} & a \cdot t^pt_1^2t_2g_1^{\pm 1} \\
+ & & + \\
[q^2(q-1)(q^2-q+1)z^2]t^3 & \xrightarrow[\text{bbm}]{1^{st} \text{ str.}} & [q^2(q-1)(q^2-q+1)z^2]t^pt_1^3g_1^{\pm 1}
\end{array}$$

where $a = q^3z + q^2(q-1)^2 + 2q^2(q-1)^2z + q(q-1)^4z$.

Following the exact same procedure as explained in § 3.5.1 and as illustrated in Figure 3.8, we have the following:

Theorem 4.1. *It suffices to consider elements in the basis of $S(\text{ST})$, Λ , and perform braid band moves on all strands in order to obtain the equations needed to compute the Homflypt skein module of the lens spaces $L(p, 1)$.*

Proof. The proof is based on Theorems 4.3, 3.5 and 3.6 and the fact that the braid band moves commute with the stabilization moves and the skein (quadratic) relation. The

fact that the braid band moves and conjugation do not commute, results in the need of performing braid band moves on all moving strands of the elements in Λ . \square

We have shown so far that it in order to compute the Homflypt skein module of the lens spaces $L(p, 1)$, it suffices to:

- (i) consider elements in Λ and
- (ii) perform bbm's on any strand.

4.2.5 From Λ to L : restrictions on the braid band moves

We now pass to the expanded set L . The advantage of this is that we restrict the performance of the braid band moves only on the first moving strand of elements in L and thus, we obtain less number of equations for the system.

Let now $\tau \in \Lambda_k$ and perform a braid band move on the j^{th} -strand. Then, we obtain the equations:

$$X_{(\hat{\tau})} = X_{(\widehat{t^p \tau_+ \cdot g_j \dots g_1^{\pm 1} \dots g_j^{-1}})},$$

that is:

$$tr(\tau) = \frac{1}{z\sqrt{\lambda}} \sqrt{\lambda^{e_1 - e_2}} \cdot tr(t^p \tau_+ \cdot g_j \dots g_1^{\pm 1} \dots g_j^{-1}) \quad (4.1)$$

where $e_1 = \sum_{i=1}^m 2ik_i$, since $\tau \in \Lambda_k$ is of the form $t^{k_0} t_1^{k_1} \dots t_m^{k_m}$ and $e_2 = \sum_{i=0}^m 2(i+1)k_i \pm 1$. Substituting to Equation 4.1 we have:

$$\begin{aligned} tr(\tau) &= \frac{\lambda^k}{z} \cdot tr(t^p \tau_+ \cdot g_j \dots g_1 \dots g_j^{-1}) && \text{for pos. bbm} \\ tr(\tau) &= \frac{\lambda^{k-1}}{z} \cdot tr(t^p \tau_+ \cdot g_j \dots g_1^{-1} \dots g_j^{-1}) && \text{for neg. bbm} \end{aligned}$$

Let now $\tau_i \in L$, such that $\tau_i < \tau, \forall i$. Performing a bbm on all τ_i 's on the first moving strand, we obtain the equations:

$$\begin{aligned} tr(\tau_i) &= \frac{\lambda^k}{z} \cdot tr(t^p \tau_{i+} \cdot g_1) && \text{for pos. bbm} \\ tr(\tau_i) &= \frac{\lambda^{k-1}}{z} \cdot tr(t^p \tau_{i+} \cdot g_1^{-1}) && \text{for neg. bbm} \end{aligned}$$

Applying Theorem 3.6 and the technique of cabling, we have that:

$$\begin{aligned} tr(\tau) &= \frac{\lambda^k}{z} \cdot tr(t^p \tau_+ \cdot g_j \dots g_1 \dots g_j^{-1}) && \widehat{=} \sum_i f_i(q, z) \frac{\lambda^k}{z} \cdot tr(t^p \tau_{i+} \cdot g_1) \\ tr(\tau) &= \frac{\lambda^{k-1}}{z} \cdot tr(t^p \tau_+ \cdot g_j \dots g_1^{-1} \dots g_j^{-1}) && \widehat{=} \sum_i h_i(q, z) \frac{\lambda^{k-1}}{z} \cdot tr(t^p \tau_{i+} \cdot g_1^{-1}) \end{aligned}$$

that is, it suffices to consider elements in the set L and perform braid band moves on their first moving strand in order to obtain equations for the system.

The above are summarized in the following Theorem:

Theorem 4.2. *The system consisting of equations obtained from elements in Λ by performing braid band moves on all their strands, is equivalent to the system consisting of equations obtained from elements in L by performing braid band moves only on their first moving strand.*

Remark 4.1. *It is worth mentioning that by performing L -moves and braid band moves on elements in the expanded set L , we can always obtain elements in L_+ , that is, elements in L where the loop generators have only positive exponents. Moreover, with the use of L -moves and braid band moves one can obtain elements in L_+ where the maximum exponent of the loop generators is $p - 1$.*

4.3 The infinite system

In this section we present results towards the solution of the infinite system. We first simplify the equations in the system and we show that the unknowns of the system commute. The main result of this section is that the system splits into self-contained subsystems.

Lemma 4.4. *Let $\tau_{0,m}^{k_{0,m}} \in \Lambda_k$, that is $\sum_{i=0}^m k_i = k$. Then, the system*

$$\begin{cases} X_{\tau_{0,m}^{k_{0,m}}} = X_{t^p \tau_{1,m+1}^{k_{0,m}} g_1} & (\spadesuit) \\ X_{\tau_{0,m}^{k_{0,m}}} = X_{t^p \tau_{1,m+1}^{k_{0,m}} g_1^{-1}} \end{cases}$$

is equivalent to

$$\begin{cases} \text{tr}(\tau_{0,m}^{k_{0,m}}) = \frac{1}{z} \cdot \lambda^{\sum_{j=0}^m k_j} \cdot \text{tr}(t^p \tau_{1,m+1}^{k_{0,m}} g_1) \\ \text{tr}(\tau_{0,m}^{k_{0,m}}) = \frac{1}{z} \cdot \lambda^{\sum_{j=0}^m k_j - 1} \cdot \text{tr}(t^p \tau_{1,m+1}^{k_{0,m}} g_1^{-1}) \end{cases} \quad (\clubsuit)$$

Proof. Applying a bbm on $\tau_{0,m}^{k_{0,m}}$ obtain $t^p \tau_{1,m+1}^{k_{0,m}} g_1^{\pm 1} \stackrel{u_{i+1}=k_i}{=} t^p \tau_{1,m+1}^{u_{1,m+1}} g_1^{\pm 1} \stackrel{u_0=p}{=} \tau_{0,m+1}^{u_{0,m+1}} g_1^{\pm 1}$. We have that:

$$X_{\tau_{0,m}^{k_{0,m}}} = \left[\frac{1}{\sqrt{\lambda z}} \right]^{m+1} \cdot \sqrt{\lambda}^{e_1} \cdot \text{tr}(\tau_{0,m}^{k_{0,m}}), \quad e_1 = \sum_{j=1}^m 2jk_j \quad (1')$$

$$X_{\tau_{0,m+1}^{u_{0,m+1}} g_1} = \left[\frac{1}{\sqrt{\lambda z}} \right]^{m+2} \cdot \sqrt{\lambda}^{e_2} \cdot \text{tr}(\tau_{0,m+1}^{u_{0,m+1}} g_1), \quad e_2 = \sum_{j=1}^{m+1} 2jk_{j-1} + 1 \quad (2')$$

$$X_{\tau_{0,m+1}^{u_{0,m+1}} g_1^{-1}} = \left[\frac{1}{\sqrt{\lambda z}} \right]^{m+2} \cdot \sqrt{\lambda}^{e_3} \cdot \text{tr}(\tau_{0,m+1}^{u_{0,m+1}} g_1^{-1}), \quad e_3 = \sum_{j=1}^{m+1} 2jk_{j-1} - 1 \quad (3')$$

We now impose $(1') = (2')$, $(1') = (3')$ and $(2') = (3')$ and since $e_2 - e_1 = 2 \sum_{j=0}^m k_j + 1$ and $e_3 - e_1 = 2 \sum_{j=0}^m k_j - 1$, we obtain:

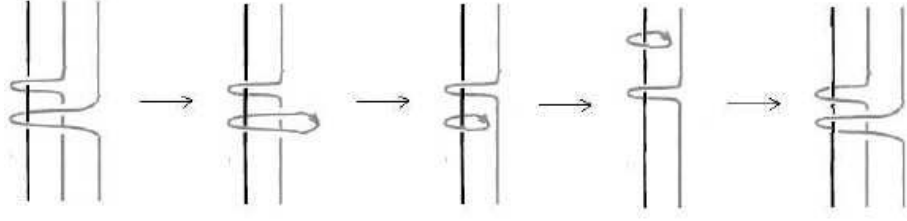

Fig. 4.3: $t^{-1}t'_1 = tt'_1^{-1}$.

$$(1') = (2') \rightarrow \text{tr}(\tau_{0,m}^{k_{0,m}}) = \frac{1}{z} \lambda^{\sum_{j=0}^m k_j} \cdot \text{tr}(\tau_{0,m+1}^{u_{0,m+1}} g_1) \quad (4')$$

$$(1') = (3') \rightarrow \text{tr}(\tau_{0,m}^{k_{0,m}}) = \frac{1}{z} \lambda^{\sum_{j=0}^m k_j - 1} \cdot \text{tr}(\tau_{0,m+1}^{u_{0,m+1}} g_1^{-1}) \quad (5')$$

$$(2') = (3') \rightarrow \text{tr}(\tau_{0,m+1}^{u_{0,m+1}} g_1) = \frac{1}{\lambda} \cdot \text{tr}(\tau_{0,m+1}^{u_{0,m+1}} g_1^{-1}) \quad (6')$$

From Eq. (6') we obtain $\text{tr}(\tau_{0,m+1}^{u_{0,m+1}} g_1) = z \text{tr}(\tau_{0,m+1}^{u_{0,m+1}})$ and so Eq. (3') becomes $\text{tr}(\tau_{0,m}^{k_{0,m}}) = \lambda^{\sum_{j=0}^m k_j} \cdot \text{tr}(\tau_{0,m+1}^{u_{0,m+1}})$. \square

Theorem 4.3. *The unknowns s_1, s_2, \dots of the system commute.*

Proof. Consider the set of all permutations of the set $S = k_1, \dots, k_n$ and let φ be a bijection from the set S to itself. We consider now the elements $\alpha = t'_{i_1}{}^{k_1} \dots t'_{i_n}{}^{k_n}$ and $\beta = t'_{i_1}{}^{\varphi(k_1)} \dots t'_{i_n}{}^{\varphi(k_n)}$, where $0 \leq i_1 \leq i_2 \leq \dots \leq i_n$ of the basis of $S(ST)$. We have that: $\text{tr}(\alpha) = s_{k_n} \dots s_{k_1}$ and $\text{tr}(\beta) = s_{\varphi(k_n)} \dots s_{\varphi(k_1)}$. We compute the invariant X on the closures $\widehat{\alpha}, \widehat{\beta}$ of α and β , respectively, and we obtain: $X_{(\widehat{\alpha})} = [-\frac{1-\lambda q}{\sqrt{\lambda}}]^{n-1} \sqrt{\lambda}^0 \text{tr}(\alpha) = [-\frac{1-\lambda q}{\sqrt{\lambda}}]^{n-1} s_{k_n} \dots s_{k_1}$ and $X_{(\widehat{\beta})} = [-\frac{1-\lambda q}{\sqrt{\lambda}}]^{n-1} \sqrt{\lambda}^0 \text{tr}(\beta) = [-\frac{1-\lambda q}{\sqrt{\lambda}}]^{n-1} s_{\varphi(k_n)} \dots s_{\varphi(k_1)}$. Now, the n -component link $\widehat{\alpha}$ is isotopic to $\widehat{\beta}$ in ST , as illustrated in Figure 4.3 for the case of two components. So, we have that $X_{(\widehat{\alpha})} = X_{(\widehat{\beta})}$, equivalently,

$$s_{k_n} \dots s_{k_1} = s_{\varphi(k_n)} \dots s_{\varphi(k_1)} \quad (4.2)$$

and so the unknowns of the system commute.

Equation 4.2 holds for any subset S of \mathbb{Z} and for any permutation ϕ of S , hence the unknowns s_i of the system (\spadesuit) must commute. \square

Theorem 4.4. *Let $\tau \in \Lambda_k \subseteq \Sigma_n$. Then $\text{tr}(\tau) = \sum_i f_i(q, z) \cdot s_{1,v}^{u_{1,v}}$, where $s_{1,v}^{u_{1,v}} := s_1^{u_1} s_2^{u_2} \dots s_v^{u_v}$, such that $u_i \in \mathbb{Z}$ for all i and $\sum_{i=1}^v u_i = k$.*

Proof. It derives directly from the fourth rule of the trace. \square

Corollary 4.1. *For $k \in \mathbb{Z}$ we obtain an infinite self-contained system from elements in Λ_k . That is, the system (\spadesuit) splits into infinite self-contained infinite subsystems.*

We now deal with elements in Λ where all loop generators have negative exponents. We do that in order to restrict the performance of the braid band moves only on elements in the set Λ where all loop generators have positive exponents (see also Remark 4.1).

Definition 4.2. (i) We define the map $f : \Lambda \rightarrow \Lambda$ such that:

$$\begin{aligned} f(\tau_1 \cdot \tau_2) &= f(\tau_1) \cdot f(\tau_2), & \forall \tau_1, \tau_2 \in \Lambda \\ t_i^k &\mapsto t_i^{-k}, & \forall i \in \mathbb{N}^*, \forall k \in \mathbb{Z} \setminus \mathbb{N} \\ g_i &\mapsto g_i^{-1}, & \forall i \in \mathbb{N}^* \end{aligned}$$

(ii) We define the map $M : R[z^{\pm 1}, s_k] \rightarrow R[z^{\pm 1}, s_k]$ such that:

$$\begin{aligned} M(\tau_1 + \tau_2) &= M(\tau_1) + M(\tau_2), & \forall \tau_1, \tau_2 \\ M(\tau_1 \cdot \tau_2) &= M(\tau_1) \cdot M(\tau_2), & \forall \tau_1, \tau_2 \\ s_{-k} &\mapsto s_k, & \forall k \in \mathbb{N} \\ s_{p-k} &\mapsto s_{p+k}, & \forall k : 0 \leq k \leq p \\ z &\mapsto \lambda \cdot z \\ q^{\pm 1} &\mapsto q^{\mp 1} \\ \frac{\lambda^k}{z} &\mapsto \frac{1}{\lambda^{k+1}z}, & \forall k \end{aligned}$$

Remark 4.2. The maps f and M are well defined. Moreover, the map f is an automorphism.

We observe now that the following diagram commutes:

$$\begin{array}{ccc} \tau & \xrightarrow{bbm} & sl_{\pm 1}(\tau) \Rightarrow X_{\widehat{\tau}} = X_{\widehat{sl_1(\tau)}}, & X_{\widehat{\tau}} = X_{\widehat{sl_{-1}(\tau)}} \\ \downarrow f & & \downarrow M & \downarrow M \\ f(\tau) & \xrightarrow{bbm} & sl_{\mp 1}(\tau) \Rightarrow X_{\widehat{f(\tau)}} = X_{\widehat{sl_{-1}(f(\tau))}}, & X_{\widehat{f(\tau)}} = X_{\widehat{sl_{+1}(f(\tau))}} \end{array}$$

that is:

$$M(X_{\widehat{\tau}} = X_{\widehat{sl_{\pm 1}(\tau)}}) \Leftrightarrow X_{\widehat{f(\tau)}} = X_{\widehat{sl_{\mp 1}(f(\tau))}}.$$

This comes from the fact that the relations in Lemmas 3.1, 3.2, 3.3 and 3.4 are symmetric (up to the sign of the exponents).

We introduce now the following notation:

Notation 4.2. We denote $s_0^{u_0} s_1^{u_1} \dots s_i^{u_i}$ by $s_{0,i}^{u_0, i}$. We also set $s_0 = 1$.

Conjecture 4.1. The map $M : R[z^{\pm 1}, s_1, s_2, \dots] \rightarrow R[z^{\pm 1}, s_1, s_2, \dots]$ (Definition 4.2(ii)) is an isomorphism.

From the discussion above and Remark 4.2, we have the following corollary of Conjugation 4.1:

Corollary 4.2. *For all $m \in \mathbb{N}$ the following relations hold:*

$$s_{-m} = \sum_{i=1}^{p-1} f_i(q, z) \cdot s_{0,i}^{u_{0,i}}, \text{ where } \sum_{j=0}^i j \cdot u_j = p - m.$$

The following example demonstrates this result.

Example 4.3. *For the element t^{-1} we have: $t^{-1} \xrightarrow{\text{bbm}} t^p t_1^{-1} \sigma_1^{\pm 1} \Leftrightarrow s_{-1} = s_{p-1}$ and $s_{-1} = a_1 s_p s_{-1} + a_2 s_{p-1}$, where $a_1, a_2 \in \mathbb{C}$.*

4.3.1 Some combinatorial results on the system

We now present some combinatorial results on the infinite system. The aim is to find the minimum number of equations needed for the computation of $S(L(p, 1))$. In other words, the aim is to exclude all linearly dependent equations so as to obtain even more control on the system.

The subset of level k of L , L_k has $\sum_{i=0}^{k-1} \binom{k-1}{i} = 2^{k-1}$ elements and by performing a positive and a negative bbm on each element in L_k , we obtain 2^k equations. We denote the subsystem obtained from elements in L_k by $[S_k]$ and by $[S_k]_-$ (respectively $[S_k]_+$) we denote the subsystem obtained from elements in L_k by only performing a negative (respectively, a positive) bbm. It is straightforward from the trace rules that the subsystem $[S_k]_-$ is obtained from $[S_{k-1}]_+$ by substituting p by $p+1$. More precisely, the following lemma holds:

Lemma 4.5. *If $[S_{k-1}]$ admits unique solution, then so does the $[S_k]_-$ subsystem.*

Lemma 4.6. *Let $\tau \in L_k \setminus \Lambda_k$. Then the equation $X_{\hat{\tau}} = X_{\widehat{t^p \tau_+ \sigma_1^{-1}}}$ is obtained from the equations:*

$$\sum_i \left(X_{\hat{\tau}_i} = X_{\widehat{t^p \tau_+ \sigma_1^{-1}}} \right),$$

where $\tau_i \in \Lambda_k$ such that $\tau_i < \tau$, $\forall i$.

We now define the following ordering relation on the unknowns of the system s_i 's, with respect to the ordering relation defined on the sets Λ' and Λ .

Definition 4.3. *Let $S_1 = s_{1,m}^{k_1, m} := s_1^{k_1} s_2^{k_2} \dots s_m^{k_m}$ and $S_2 = s_{1,n}^{l_1, n} := s_1^{l_1} s_2^{l_2} \dots s_n^{l_n}$. Then:*

(a) *If $\sum_{i=1}^m k_i \cdot i < \sum_{j=1}^n l_j \cdot j$, then $S_1 < S_2$.*

(b) *If $\sum_{i=1}^m k_i \cdot i = \sum_{j=1}^n l_j \cdot j$ and $\sum_{i=1}^m k_i < \sum_{j=1}^n l_j$, then $S_1 < S_2$.*

(c) *If $\sum_{i=1}^m k_i \cdot i = \sum_{j=1}^n l_j \cdot j$, $\sum_{i=1}^m k_i = \sum_{j=1}^n l_j$ and $k_1, l_1 \neq 0, k_2, l_2 \neq 0, \dots, k_i \neq 0, l_i = 0$, then $S_1 < S_2$.*

Remark 4.3. (a) If $k_i, l_i \neq 0$ for the same indices, then $\sum_{i=1}^m k_i \neq \sum_{j=1}^n l_j$.

(b) Let $s_1^{k_1} s_2^{k_2} \dots s_m^{k_m}$ such that $\sum_{i=1}^m k_i \cdot i = k$. It follows from Definition 4.3 the maximum unknown element is s_1^k and the minimum is s_k .

(c) Let $\tau_1 \in L_k$ and $\tau_2 \in L_m$ such that $k < m$, then the equation $X_{\widehat{\tau_2}} = X_{t^p \tau_2 + \sigma_1^{-1}}$ contains more unknowns (which are higher ordered) than the equation $X_{\widehat{\tau_1}} = X_{t^p \tau_1 + \sigma_1^{-1}}$.

Proposition 4.6. For $\tau_{0,m}^{k_0,m} \in L$, the following relation holds:

$$\text{tr}(\tau_{0,m}^{k_0,m}) = q^{\sum_{i=1}^m k_i \cdot i} s_{k_0, k_m} + \sum f(q, z) s_{\lambda_0, \lambda_m},$$

where $s_{\lambda_0, \lambda_m} < s_{k_0, k_m}$ for all s_{λ_0, λ_m} .

Proof. It follows from Proposition 3.8. □

Lemma 4.7. i) Let $\tau_1 < \tau_2 \in \Lambda_k^+$ such that $\nexists \tau_3 \in \Lambda_k^+ : \tau_1 < \tau_3 < \tau_2$, then, if the number of unknowns in $X_{\widehat{\tau_1}} = X_{t^p \tau_1 + \sigma_1^{-1}}$ is R , then the number of unknowns in $X_{\widehat{\tau_2}} = X_{t^p \tau_2 + \sigma_1^{-1}}$ is $R + 1$.

ii) If $\tau \in L^+ \setminus \Lambda^+$ and $\tau_1 \in \Lambda^+$ such that $\tau_1 < \tau$ and such that $\nexists \tau_2 \in \Lambda^+ : \tau_1 < \tau_2 < \tau$, then the (number of) unknowns in $X_{\widehat{\tau}} = X_{t^p \tau + \sigma_1^{-1}}$ are (is) the same as in $X_{\widehat{\tau_1}} = X_{t^p \tau_1 + \sigma_1^{-1}}$.

Proof. It follows from the trace rules. □

Note that the equation $X_{t t_1 \dots t_{k-1}} = X_{t^p t_1 \dots t_k \sigma_1}$ contains all the unknowns of the $[S_k]$ subsystem, since $t t_1 \dots t_{k-1}$ is the maximum element in Λ_k . We also have that $\text{tr}(t^p t_1 \dots t_k \sigma_1) = \sum_i f_i(q, z) s_{p+i}^{k_{i_1}} \dots s_m^{k_{i_m}}$, such that

$$\sum_{j=1}^m k_{i_j} \cdot j = k - i \tag{4.3}$$

and such that $k_{i_j} > 0$ for all i, j . This is equivalent to finding the number of non negative solutions of the linear Diophantine equation 4.3. This equations has $\sum_{i=0}^k H_i$ solutions, where

$$H_i = \sum_{w_1=0}^{\lfloor \frac{k}{1} \rfloor} \sum_{w_2=0}^{\lfloor \frac{k-w_1}{2} \rfloor} \dots \sum_{w_{k-1}=0}^{\lfloor \frac{k-w_1-2w_2-\dots-(k-1)w_{k-2}}{k-1} \rfloor} I(k; w_1, w_2, \dots, w_{k-1}),$$

and where $I(k; w_1, w_2, \dots, w_{k-1}) = 1$, if $k/k - w_1 - 2w_2 - \dots - (k-2)w_{k-2}$ and $I(k; w_1, w_2, \dots, w_{k-1}) = 0$, otherwise (see [RM10]).

The point now is to find the infinite many linearly independent equations obtained for the system and prove that the number of those equations equal the number of the unknowns. Then, the system would admit unique solution, or equivalently, the following set, which is different than the one found in [GM14], would be a basic set for $S(L(p, 1))$:

$$B_p = \{t^{d_0} t_1^{d_1} \dots t_m^{d_m} : m \in \mathbb{N}, d_i \in \mathbb{N}^* \forall i : d_0 < d_1 < \dots < d_m \leq p-1\} \cup \{\emptyset\}.$$

This is equivalent to proving the following conjecture:

Conjecture 4.2. *For $j \in \mathbb{N}$ such that $j > p$, the following relations hold:*

$$s_j = \sum_{i=1}^{p-1} f_i(q, z) \cdot s_{0,i}^{u_{0,i}}, \text{ where } \sum_{j=0}^i j \cdot u_j = j - p.$$

Example 4.4. *For the element $t \in L_1$ we have: $t \xrightarrow{bbm} t^p t_1 \sigma_1^{\pm 1} \Leftrightarrow s_{p+1} = s_1$.*

For the elements in L_2 we have:

- $t^2 \xrightarrow{bbm} t^p t_1^2 \sigma_1^{\pm 1} :$

$$\begin{cases} s_2 = a_1 s_{p+2} + a_2 s_{p+1} s_1 + a_3 s_p s_2 \\ s_2 = b_1 s_{p+2} + b_2 s_{p+1} s_1 \end{cases}$$

- $tt_1 \xrightarrow{bbm} t^p t_1 t_2 \sigma_1^{\pm 1} :$

$$\begin{cases} s_2 + s_1^2 = c_1 s_{p+2} + c_2 s_{p+1} s_1 \\ s_2 + s_1^2 = d_1 s_{p+2} + d_2 s_{p+1} s_1 + d_3 s_p s_2 + d_4 s_p s_1^2 \end{cases}$$

and thus:

$$\begin{cases} s_{p+2} = A_1 s_2 + A_2 s_1^2 \\ s_2 s_p = B_1 s_2 + B_2 s_1^2 \\ s_1 s_{p+1} = C_1 s_2 + C_2 s_1^2 \\ s_p s_1^2 = D_1 s_2 + D_2 s_1^2 \end{cases}$$

where $a_i, A_i, b_i, B_i, c_i, C_i, d_i, D_i \in \mathbb{C}, \forall i$.

4.4 Appendix

In this section we provide some lemmas in order to investigate some further properties of the system and prove Conjecture 4.2.

Lemma 4.8. For $k \in \mathbb{N}$ the following relations hold.

$$\begin{aligned}
(i) \quad \text{tr}(t^p t_1^k g_1) &= q^k z s_{p+k} + \sum_{j=0}^{k-1} q^j (q-1) \text{tr}(t^{p+j} t_1^{k-j}) \\
(ii) \quad \text{tr}(t^p t_1^k g_1^{-1}) &= q^{k-1} z s_{p+k} + \sum_{j=0}^{k-2} q^j (q-1) \text{tr}(t^{p+1+j} t_1^{k-1-j}) \\
(iii) \quad \text{tr}(t^p t_1^k g_1) &= (q^2 - q + 1) \text{tr}(t^{p+1} t_1^{k-1} g_1) + q^k (q-1) s_k s_p + \\
&\quad + \sum_{j=2}^k q^{j-1} (q-1)^2 \text{tr}(t^{p+k-j} t_1^j g_1) \\
(iv) \quad \text{tr}(t^p t_1^k) &= \sum_{j=0}^k f_j(q, z) s_{p+k-j} s_j
\end{aligned}$$

Proof. (i) We prove relations (i) by induction on k . For $k = 1$ we have $\text{tr}(t^p t_1 g_1) = (q-1) \text{tr}(t^p t_1) + q \text{tr}(t^p g_1 t) = (q-1) \text{tr}(t^p t_1) + q z s_{p+1}$. Suppose that the relation holds for $k-1$. Then for k we have:

$$\begin{aligned}
\text{tr}(t^p t_1^k g_1) &= (q-1) \text{tr}(t^p t_1^k) + q \text{tr}(t^{p+1} t_1^{k-1} g_1) && \stackrel{\text{ind. step}}{=} \\
&= (q-1) \text{tr}(t^p t_1^k) + q \sum_{j=0}^{k-2} q^j (q-1) \text{tr}(t^{p+1+j} t_1^{k-1-j}) + q^k z s_{p+k} && \stackrel{j=u-1}{=} \\
&= q^k z s_{p+k} + q^0 (q-1) \text{tr}(t^p t_1^k) + \sum_{u=1}^{k-1} q^u (q-1) \text{tr}(t^{p+u} t_1^{k-u}) && = \\
&= q^k z s_{p+k} + \sum_{u=0}^{k-1} q^u (q-1) \text{tr}(t^{p+u} t_1^{k-u}).
\end{aligned}$$

(ii) Relations (ii) follow similarly since $\text{tr}(t^p t_1^k g_1^{-1}) = \text{tr}(t^{p+1} t_1^{k-1} g_1)$.

(iii) Relations (iii) follow by induction on k .

(iv) We have that: $t_1^k = q^k t_1^{k-1} - \sum_{j=1}^k q^j (q^{-1} - 1) t_1^{j-1} t_1^{k+1-j} g_1^{-1}$ (Lemma 9 [DL15]) and so

$$\text{tr}(t^p t_1^k) = q^k s_k s_p - \sum_{j=1}^k q^j (q^{-1} - 1) \text{tr}(t^{p+j-1} t_1^{k+1-j} g_1^{-1}).$$

We also have that:

$$\text{tr}(t^{p+j-1} t_1^{k+1-j} g_1^{-1}) = q^{k-j} z s_{p+k} + \sum_{i=0}^{k-1-j} q^i (q-1) \text{tr}(t^{p+i+j} t_1^{k-i-j}) \text{ and thus}$$

$$\begin{aligned}
\text{tr}(t^p t_1^k) &= q^k s_k s_p - k q^k (q^{-1} - 1) z s_{p+k} - \\
&\quad - \sum_{j=1}^k \left(\sum_{i=0}^{k+1-j} q^{j+i} (q-1) (q^{-1} - 1) \text{tr}(t^{p+j+i} t_1^{k-j-i}) \right) \quad (a).
\end{aligned}$$

We prove now relations (iv) by induction on k . For $k = 1$ we have $\text{tr}(t^p t_1) = q s_1 s_p + (q-1) z s_{p+1}$. Suppose that it holds for $k = 1, \dots, m-1$.

Then for $k = m$ we have:

$$\begin{aligned}
tr(t^p t_1^m) &\stackrel{(a)}{=} q^m s_m s_p - m q^m (q^{-1} - 1) z s_{m+p} - \\
&- \sum_{j=1}^m \left(\sum_{i=0}^{m+1-j} q^{j+i} (q-1)(q^{-1}-1) tr(t^{p+j+i} t_1^{m-j-i}) \right) \stackrel{ind.step}{=} \\
&= q^m s_m s_p - m q^m (q^{-1} - 1) z s_{m+p} - \\
&- \sum_{j=1}^m \sum_{i=0}^{m+1-j} q^{j+i} (q-1)(q^{-1}-1) \left(\sum_{r=0}^{m-i-j} f_r(q, z) s_{p+m-r} s_r \right) = \\
&= \sum_{\mu=0}^m f_{\mu}(q, z) s_{p+k-\mu} s_{\mu}
\end{aligned}$$

□

BIBLIOGRAPHY

- [Ada94] C. Adams, *The Knot Book*, New York: Freeman & Co., 1994.
- [Art47] E. Artin, *Theory of braids*, *Annals of Mathematics* **(2) 48** (1947), 101–126.
- [Bir74] J. S. Birman, *Braids, links and mapping class groups*, Princeton, NJ: Princeton Univ. Press, *Ann. Math. Stud.*, 1982, 1974.
- [Bla00] C. Blanchet, *Hecke algebras, modular categories and 3-manifolds quantum invariants*, *Topology* **39** (2000), no. 1, 193–223.
- [BM02] J. S. Birman and W. W. Menasco, *On Markov's theorem*, *Journal of Knot Theory and its Ramifications* **11 (3)** (2002), 295–310.
- [DL13] I. Diamantis and S. Lambropoulou, *Braid equivalence for 3-manifolds with rational surgery description*, arXiv:1311.2465 [math.GT], 2013.
- [DL15] ———, *A new basis for the Homflypt skein module of the solid torus*, *Journal of Pure and Applied Algebra* (2015), DOI 10.1016/j.jpaa.2015.06.014.
- [GM14] B. Gabrovsek and M. Mroczkowski, *The Homflypt skein module of the lens spaces $L(p, 1)$* , *Topology Appl.* (2014), no. 175, 72–80.
- [HK90] J. Hoste and M. Kidwell, *Dichromatic link invariants*, *Trans. Amer. Math. Soc.* **321** (1990), no. 1, 197–229.
- [HP93] J. Hoste and J. H. Przytycki, *The $(2, \infty)$ -skein module of lens spaces; a generalization of the Jones polynomial*, *Journal of Knot Theory and Its Ramifications* **2 (3)** (1993), 321–333.
- [HP95] ———, *The Kauffman bracket skein module of $S^1 \times S^2$* , *Math. Z.* **220 (1)** (1995), 63–73.
- [IDP] S. Lambropoulou I. Diamantis and J. H. Przytycki, *The Homflypt skein module of the lens spaces $L(p, 1)$ via braids*, manuscript in preparation.

- [Jon85] V. F. R. Jones, *A polynomial invariant for links via neumann algebras*, Bull. Amer. Math. Soc. **129** (1985), 103–112.
- [Jon87] ———, *Hecke algebra representations of braid groups and link polynomials*, Ann. Math. **126** (1987), 335–388.
- [KL] D. Kodokostas and S. Lambropoulou, *Knot theory for 3-manifolds represented by the 2-unlink*, in preparation.
- [KS92] K. H. Ko and L. Smolinsky, *The framed braid group and 3-manifolds*, Proceedings of the American Mathematical Society **115** (1992), no. 2, 541–551.
- [Lam94] S. Lambropoulou, *Solid torus links and Hecke algebras of B-type*, Quantum Topology; D.N. Yetter Ed.; World Scientific Press (1994), 225–245.
- [Lam99] ———, *Knot theory related to generalized and cyclotomic Hecke algebras of type B*, J. Knot Theory Ramifications **8** (1999), no. 5, 621–658.
- [Lam00] ———, *Braid structures in handlebodies, knot complements and 3-manifolds*, Proceedings of Knots in Hellas '98 (C. Gordon, V. F. R. Jones, L.H. Kauffman, S. Lambropoulou, and J. H. Przytycki, eds.), Series of Knots and Everything, vol. 24, World Scientific Press, 2000, pp. 274–289.
- [Lam07] ———, *L-moves and Markov theorems*, J. Knot Theory Ramifications **16** (2007), no. 10, 1–10.
- [LG97] S. Lambropoulou and M. Geck, *Markov traces and knot invariants related to the Iwahori-Hecke algebras of type B*, J. für die reine und angewandte Mathematic **482** (1997), 191–213.
- [Lic97] W. B. R. Lickorish, *An introduction to knot theory*, Springer-Verlag, New York, volume 175 of Graduate Texts in Mathematics, 1997.
- [LM87] W. B. R. Lickorish and K. Millett, *A polynomial invariant of oriented links*, Topology **26** (1987), 107–141.
- [LR97] S. Lambropoulou and C.P. Rourke, *Markov's theorem in 3-manifolds*, Topology and its Applications **78** (1997), no. 2, 95–122.
- [LR06] S. Lambropoulou and C. P. Rourke, *Algebraic Markov equivalence for links in 3-manifolds*, Compositio Math. **142** (2006), 1039–1062.
- [MA97] H. Morton and A. Aiston, *Young diagrams, the Homfly skein of the annulus and unitary invariants*, Proc. of Knots 96, World Scientific (1997), 31–45, edited by S. Suzuki.
- [Mos71] L. Moser, *Elementary surgery along a torus knot*, Pacific J. Math. **38** (1971), 737–745.

- [OL02] R. Haring Oldenburg and S. Lambropoulou, *Knot theory in handlebodies*, J. Knot Theory and Ramifications **11** (2002), no. 6, 921–943.
- [PF85] J. Hoste W. B. R. Lickorish K. Millett A. Ocneanu P. Freyd, D. Yetter, *A new polynomial invariant of knots and links*, Bull. Amer. Math. Soc. **12** (1985), 239–249.
- [Prz92] J. Przytycki, *Skein module of links in a handlebody*, Topology 90 (1992), 315–342, Proc. of the Research Semester in Low Dimensional Topology at OSU, Editors: B.Apanasov, W.D.Neumann, A.W.Reid, L.Siebenmann, De Gruyter Verlag.
- [PS97] V. V. Prasolov and A. B. Sossinsky, *Knots, Links, Braids and 3-manifolds: An introduction to the new invariants in Low-Dimensional Topology*, American Mathematical Society, Translations of Mathematical Monographs Reprint, 1997.
- [RM10] A. Farzaneh G. Howell R. Mahmoudrand, H. Hassani, *The exact number of nonnegative integer solutions for a linear diophantine inequality*, IAENG International Journal of Applied Mathematics **40** (2010), no. 1.
- [Rol76] D. Rolfsen, *Knots and Links*, Publish or Perish, Inc., Berkeley, CA, 1976.
- [Rol84] ———, *Rational surgery calculus: Extension of Kirby’s theorem*, Pacific Journal of Mathematics **110** (1984), no. 2, 337–386.
- [Sav99] N. Saveliev, *Lectures on the Topology of 3-manifolds. An introduction to the Casson invariant*, De Gruyter Textbook, 1999.
- [Sko91] R. Skora, *Knot and link projections in 3-manifolds*, Math. Z. **206** (1991), 345–350.
- [Sko92] ———, *Closed braids in 3-manifolds*, Math. Zeitschrift **211** (1992), 173–187.
- [Sos92] A. B. Sossinsky, *Preparation theorems for isotopy invariants of links in 3-manifolds*, Quantum Groups, Proceedings, Lecture Notes in Math., Springer-Verlag, Berlin a.o **1510** (1992), 354–362.
- [Sun91] P.A. Sundheim, *Reidemeister’s theorem for 3-manifolds*, Math. Proc. Camb. Phil. Soc. **110** (1991), 281–292.
- [Sun93] ———, *The Alexander and Markov theorems via diagrams for links in 3-manifolds*, Transactions of the American Mathematical Society **337** (1993), no. 2, 591–607.
- [Tur88] V.G. Turaev, *The Conway and Kauffman modules of the solid torus*, Zap. Nauchn. Sem. Lomi **167** (1988), 79–89, English translation: it J. Soviet Math. (1990), 2799-2805.