

# Οικισμοί έκτακτης ανάγκης

Μια Γραμματική Προσέγγιση Σχεδιασμού, Χωροθέτησης και Προκατασκευής Υποδομών Έκτακτης Μαζικής Κατοίκησης

Σπουδαστής: Ανδρέου Γεώργιος αρ16711

Επιβλέπων Καθηγητής: Κωτσόπουλος Σωτήριος

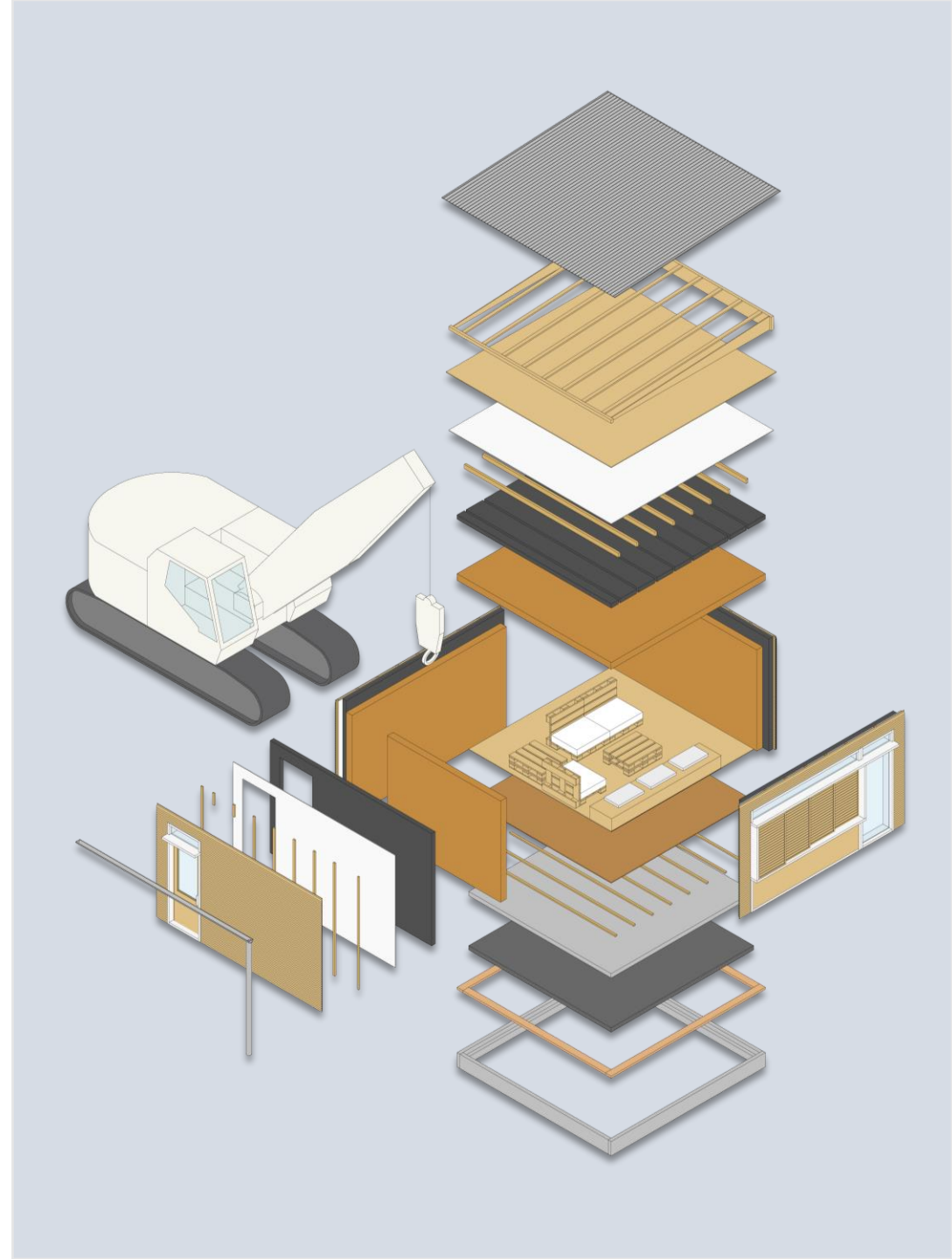
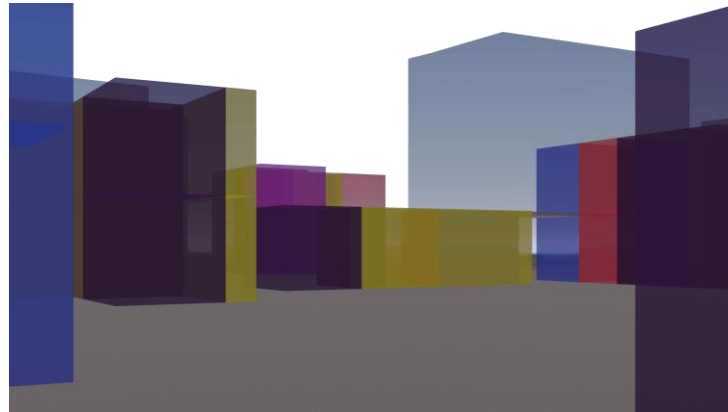
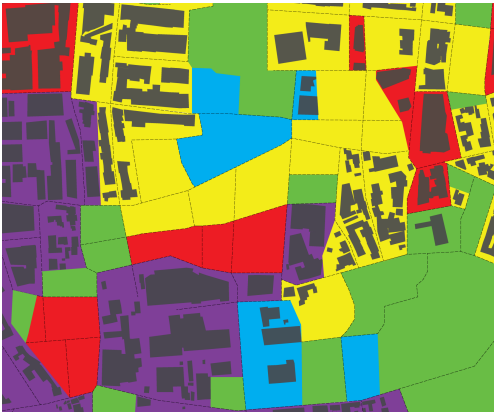
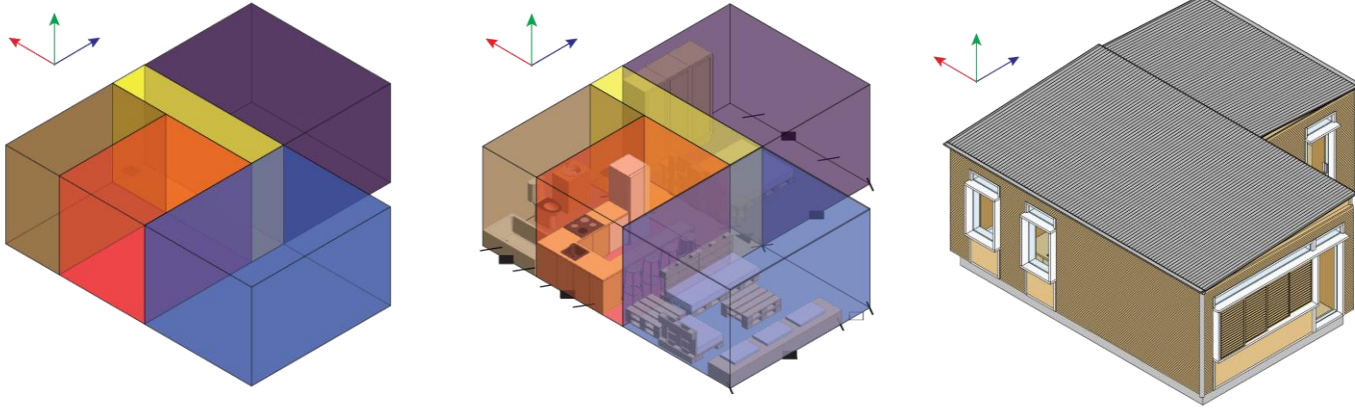

Ευχαριστώ  
τον κ. Κωτσόπουλο για όλη την συνεργασία μας,  
τον κ. Βαγενά για την συμβουλευτική του στα προπλάσματα,  
και την οικογένεια μου και φίλους για την βοήθεια και την συμπαράσταση  
τους

## ΠΡΟΒΛΗΜΑ

Η έκτακτη ανάγκη για μαζική κατοίκηση.

## ΣΤΟΧΟΣ

Μία μεθοδολογία για τον σχεδιασμό οικισμών εκτάκτου ανάγκης.



## ΣΥΝΕΙΣΦΟΡΕΣ

- Παρουσιάζεται μία συστηματική μέθοδος σχεδιασμού για μαζική κατοίκηση έκτακτης ανάγκης.
- Χρησιμοποιείται για πρώτη φορά, στην έκτακτη ανάγκη, η γραμματική σχημάτων ως παραγωγικό και αναλυτικό μέσο.
- Παρουσιάζονται γραμματικές σε τρεις κλίμακες: σχεδιαστική, οικοδομική και πολεοδομική.

## ΣΥΝΕΙΣΦΟΡΕΣ

- Η μέθοδος αυτή είναι καινοτόμα γιατί:
  - προσφέρει δυνατότητα αυτοματισμού
  - δημιουργεί εναλλακτικές λύσεις για την οργάνωση, την κατασκευή και την χωροθέτηση έκτακτων οικισμών
  - συστηματοποιεί την παραγωγή χωρίς να υποβιβάζει το ποιοτικό αποτέλεσμα

1. Εισαγωγή
2. Ερευνητικό υπόβαθρο
3. Σχεδιασμός καταλυμάτων πρώτης βοήθειας
4. Κατασκευή καταλυμάτων πρώτης βοήθειας
5. Χωροθέτηση καταλυμάτων πρώτης βοήθειας
6. Σχεδιασμός καταλυμάτων επανένταξης
7. Οικοδομική καταλυμάτων επανένταξης
8. Χωροθέτηση καταλυμάτων επανένταξης
9. Συμπεράσματα και συνεισφορές

## 2. Ερευνητικό Υπόβαθρο

## ΓΡΑΜΜΑΤΙΚΗ ΣΧΗΜΑΤΩΝ

- Διαδικασία που επιτρέπει την παραγωγή μιας αρχιτεκτονικής γλώσσας με συγκεκριμένα βήματα, που μπορούν να εκφραστούν ως υπολογιστικοί κανόνες.
- Εργαλείο ανάλυσης και σύνθεσης που χρησιμοποιεί βασικά σύμβολα και σχήματα ως κανόνες μετατροπής.



## ΓΙΑΤΙ ΕΠΙΛΕΧΘΗΚΕ

- Η διαδικασία παραγωγής είναι κατάλληλη για την συστηματική παραγωγή καταλυμάτων
- Συμβάλλει στον αποτελεσματικό σχεδιασμό, κατασκευή και παράδοση.
- Μπορεί να αυτοματοποιηθεί.

# ΔΙΑΔΙΚΑΣΙΑ

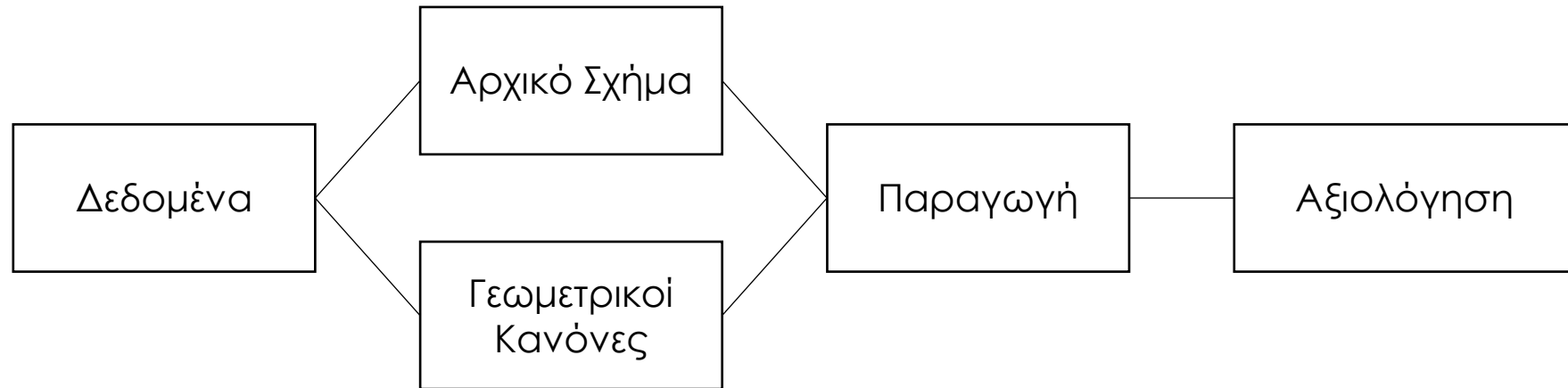

# ΓΡΑΜΜΑΤΙΚΟΙ ΚΑΝΟΝΕΣ

$A \rightarrow B$

Κανόνας 1

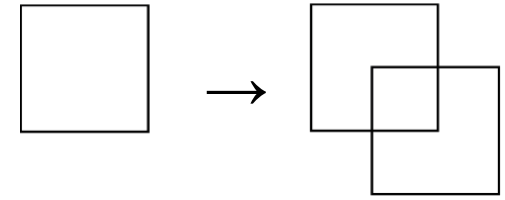

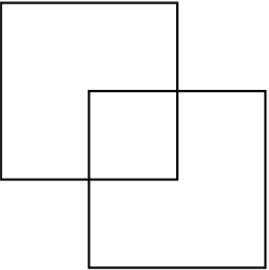
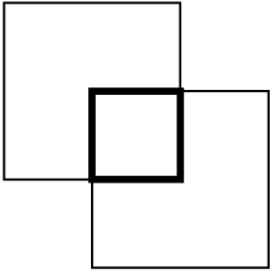
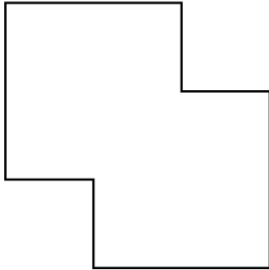
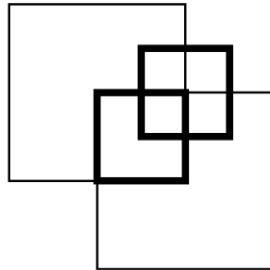
C	$t(A) \leq C$	$C - t(A)$	$C' = C - t(A) + t(B)$
			

# ΠΑΡΑΓΩΓΗ

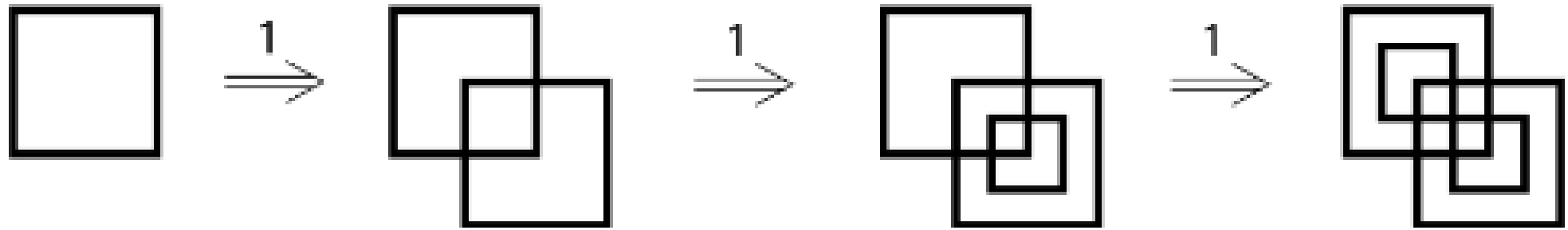

$$S_0 \Rightarrow S_1 \Rightarrow S_2 \Rightarrow S_3 \Rightarrow \dots \Rightarrow S_n$$



## ΣΤΑΤΙΣΤΙΚΑ

- Αστεγεία:  
Παγκόσμια υπάρχουν 1,8 δισεκατομμύρια άτομα χωρίς επαρκής κατοίκηση  
Εκ των οποίων 150 εκατομμύρια ζουν στο δρόμο  
15 εκατομμύρια χάνουν την κατοικία τους κάθε χρόνο
- Προσφυγιά:  
Η UNCHR υπολόγισε ότι 89 εκατομμύρια άνθρωποι παγκόσμια ήταν εκτοπισμένοι τα τέλη του 2021
- Καταστροφές:  
Μετά από τον πρόσφατο σεισμό στην Τουρκία και Συρία πάνω από 6 εκατομμύρια άνθρωποι μένουν σε σκηνές έκτακτης ανάγκης

# ΦΑΣΕΙΣ ΑΝΤΙΜΕΤΩΠΙΣΗΣ



Φάση πρώτων βοηθειών

# ΦΑΣΕΙΣ ΑΝΤΙΜΕΤΩΠΙΣΗΣ



Φάση επανένταξης



# ΦΑΣΕΙΣ ΑΝΤΙΜΕΤΩΠΙΣΗΣ

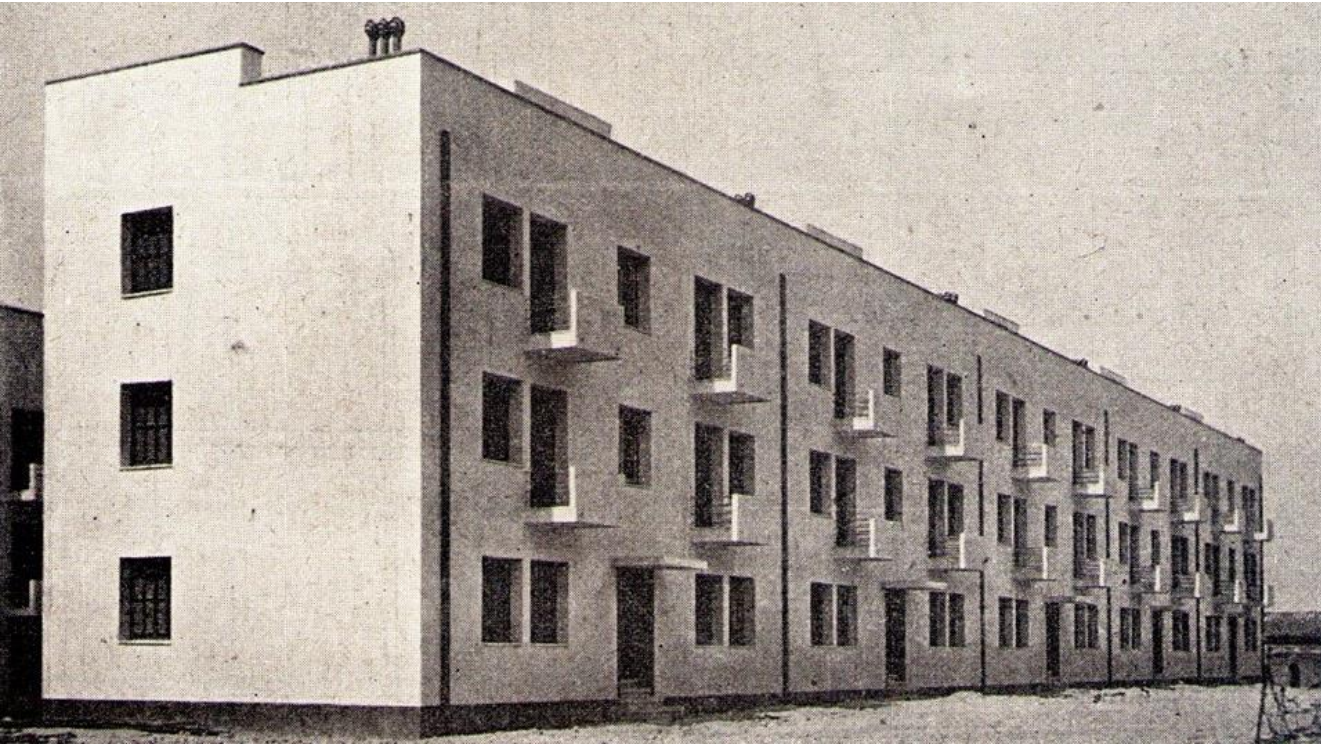

Φάση ανακατασκευής



# ΠΡΩΤΩΝ ΒΟΗΘΕΙΩΝ



The buBbLe Prototype των  
MMASA Studio και Cipriano Chas  
2009

## ΕΠΑΝΕΝΤΑΞΗΣ



Prefabricated Refugee camp shelters, της εταιρίας "Karmod Modular Buildings"

# ΕΠΑΝΕΝΤΑΞΗΣ



Temporary Housing Scheme for  
Displaced Ukrainians από Balbek  
Bureau 2022

# ΑΝΑΚΑΤΑΣΚΕΥΗΣ



Prefab Social Housing in France,  
Tectoniques Architectes 2016

# ΑΝΑΚΑΤΑΣΚΕΥΗΣ



Prefab Social Housing in Denmark,  
Bjarke Ingels Group 2018

### 3. Σχεδιασμός Καταλυμάτων Πρώτης Βοήθειας



# PAPER EMERGENCY SHELTERS SHIGERU BAN (1994)

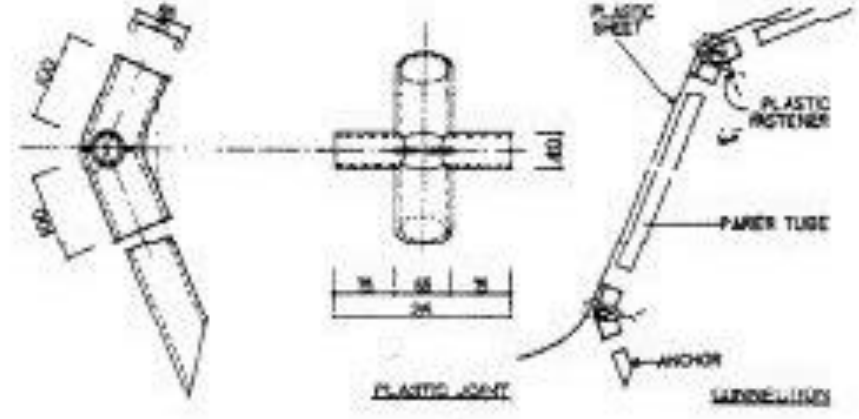
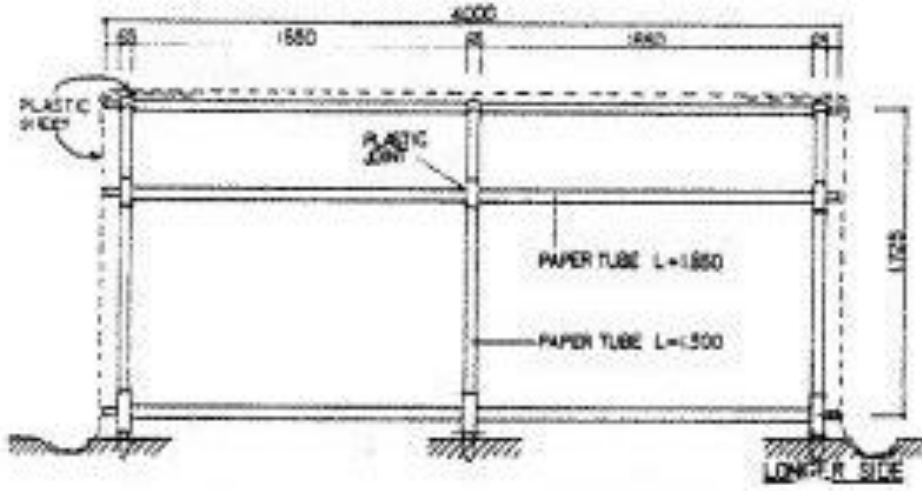
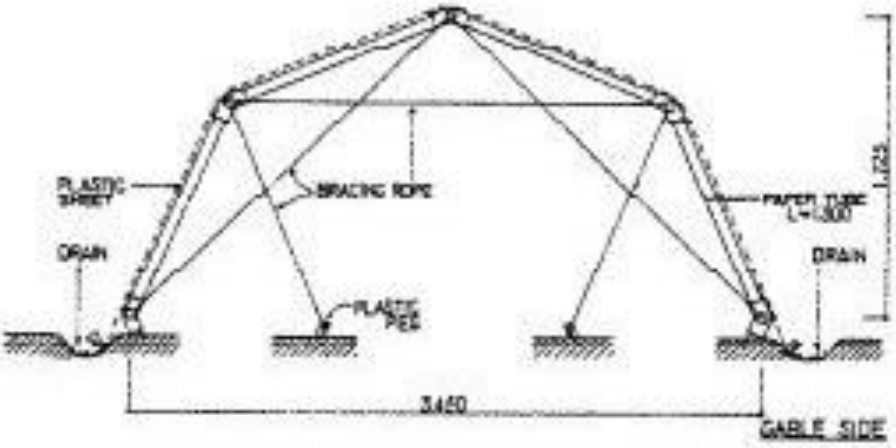

# PAPER EMERGENCY SHELTERS SHIGERU BAN (1994)

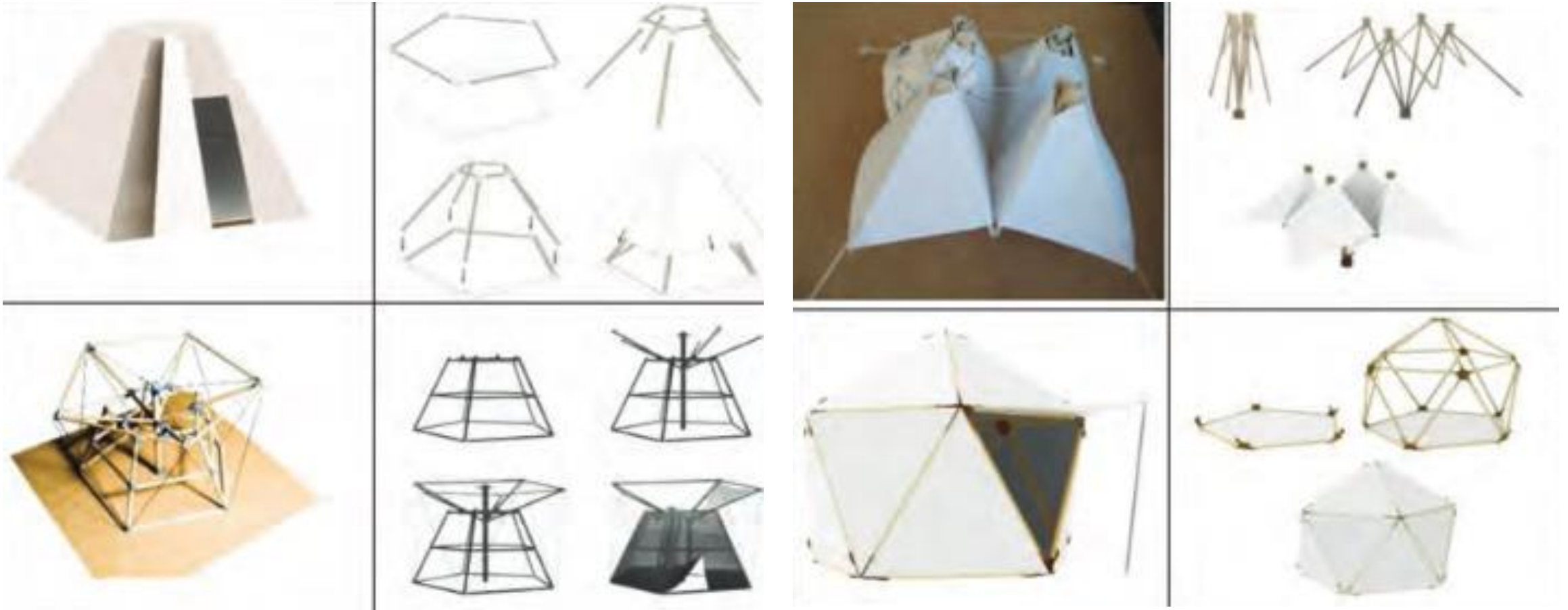

Συνθέσεις με την κατασκευαστική λογική των Paper Emergency Shelter, Jin-Ho Park (2017)

# ΚΑΤΑΛΥΜΑΤΑ ΠΡΩΤΗΣ ΑΝΑΓΚΗΣ

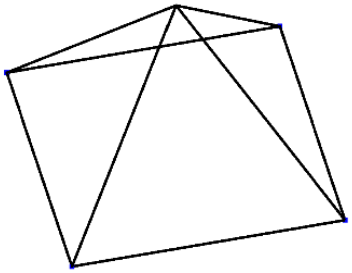

N-γωνική Πυραμίδα

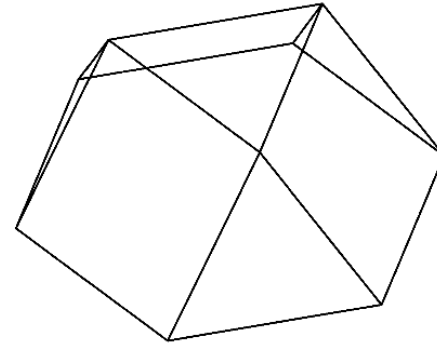

N-γωνική Κόππολα

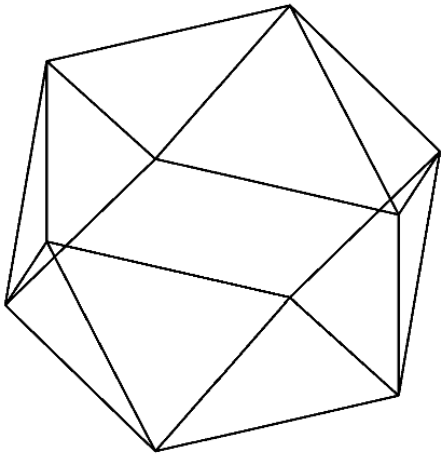

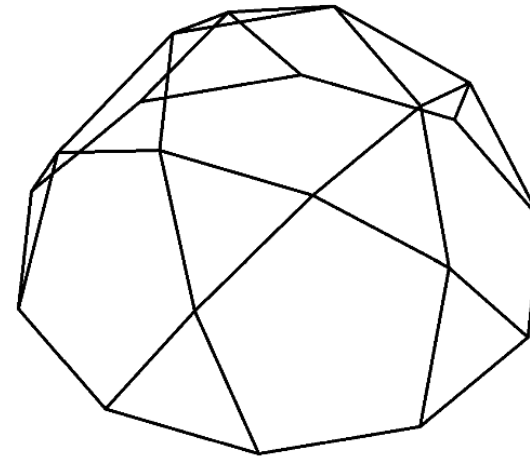

N-γωνικό Αντίπρισμα



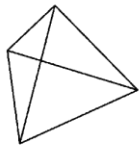
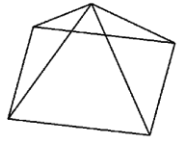
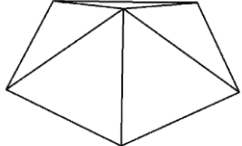

N-γωνική Ροτόντα

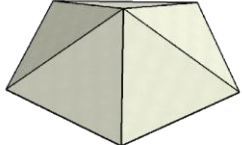



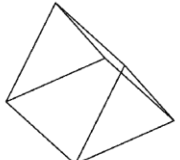
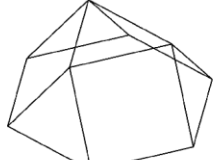
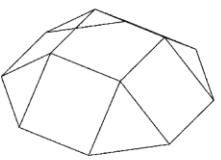
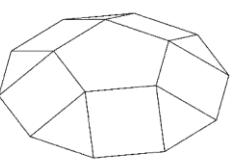

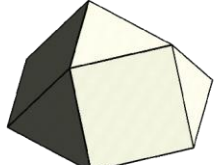
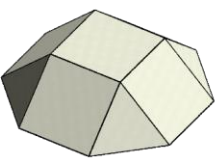
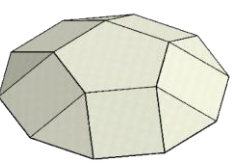
## N-γωνική Πυραμίδα

$\begin{matrix} v \\ u \end{matrix}$	3-γωνο	4-γωνο	5-γωνο
$U_{13}$			
$U_{13} \times U_{23}$			

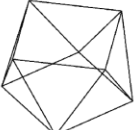
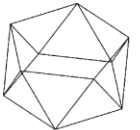
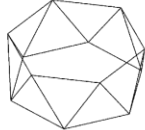

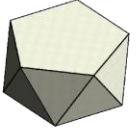
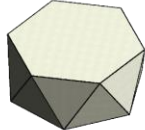
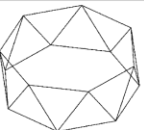



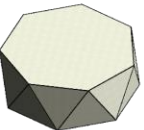
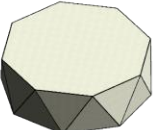
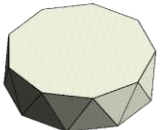
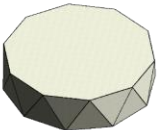

## N-γωνική Κόππολα

$\begin{matrix} v \\ u \end{matrix}$	4-γωνο	6-γωνο	8-γωνο	10-γωνο
$U_{13}$				
$U_{13} \times U_{23}$				

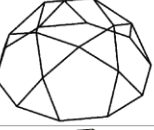
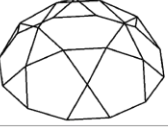
## N-γωνικό Αντίπρισμα

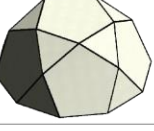
$\begin{matrix} v \\ u \end{matrix}$	3-γωνο	4-γωνο	5-γωνο	6-γωνο
$U_{13}$				
$U_{13} \times U_{23}$				
$\begin{matrix} v \\ u \end{matrix}$	7-γωνο	8-γωνο	9-γωνο	10-γωνο
$U_{13}$				
$U_{13} \times U_{23}$				

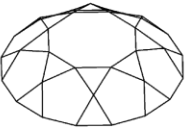
## N-γωνική Ροτόντα

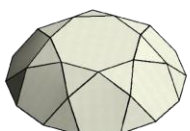
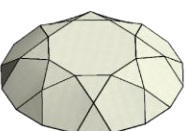
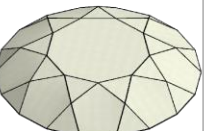
$\begin{matrix} v \\ u \end{matrix}$	6-γωνο	8-γωνο	10-γωνο	12-γωνο
$U_{13}$				
$U_{13} \times U_{23}$				
$\begin{matrix} v \\ u \end{matrix}$	14-γωνο	16-γωνο	18-γωνο	
$U_{13}$				
$U_{13} \times U_{23}$				

ΑΡΧΙΚΟ ΣΧΗΜΑ

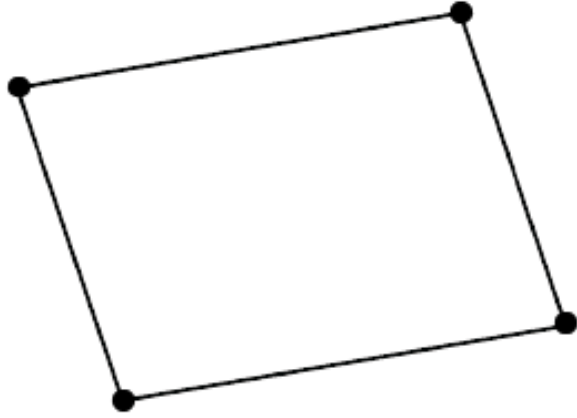

# ΓΕΩΜΕΤΡΙΚΟΙ ΚΑΝΟΝΕΣ

Σημείο

(1)

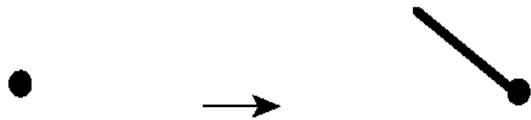

Επίπεδο

(2)

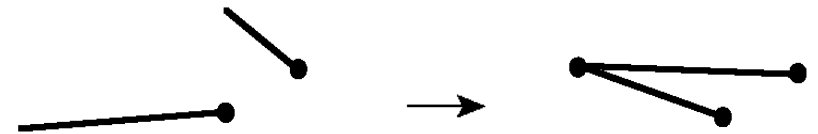

Χώρος

(3)

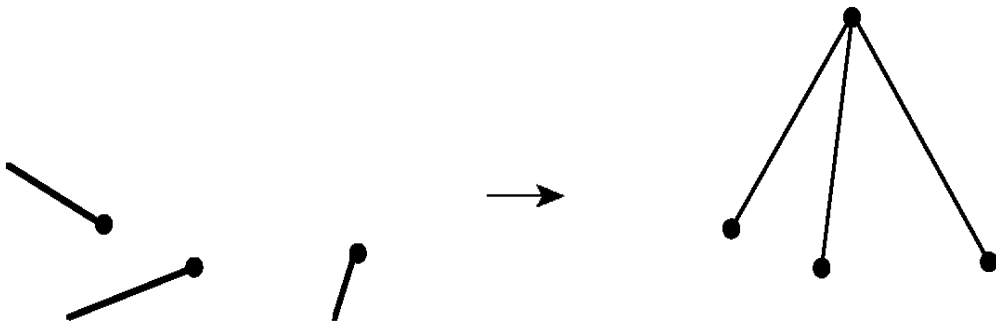

(4)

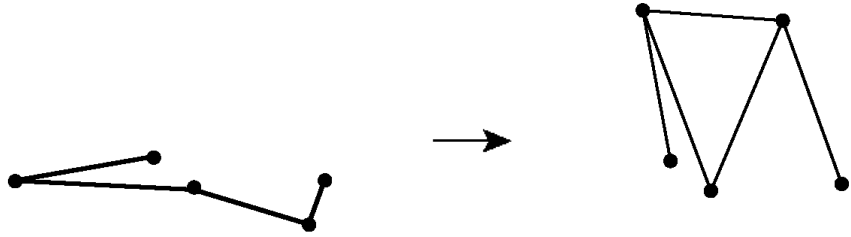

(5)

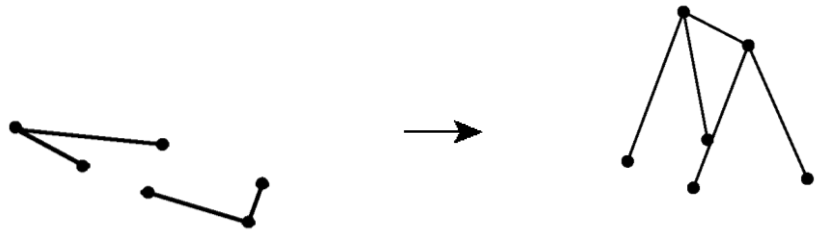

ΠΑΡΑΔΕΙΓΜΑ ΕΦΑΡΜΟΓΗΣ ΚΑΝΟΝΑ 4

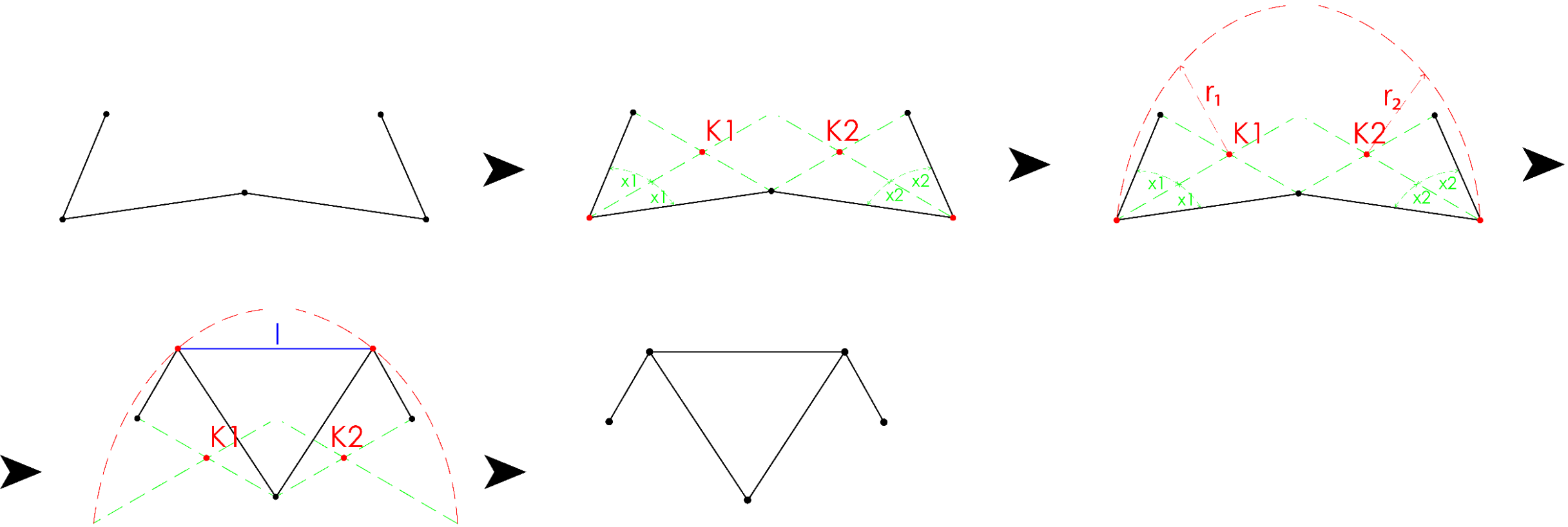



ΠΑΡΑΔΕΙΓΜΑ ΕΦΑΡΜΟΓΗΣ ΚΑΝΟΝΑ 5

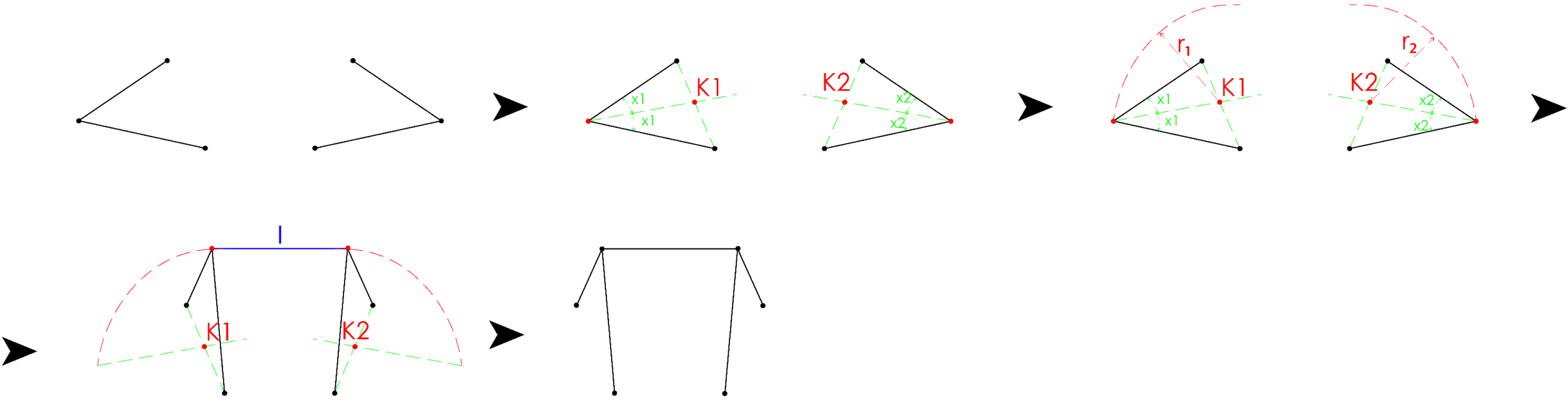

(6)

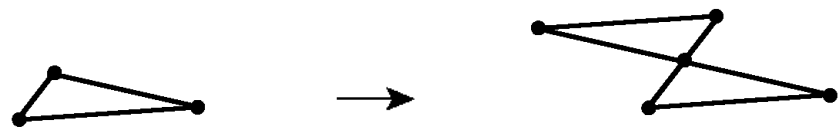

(7)

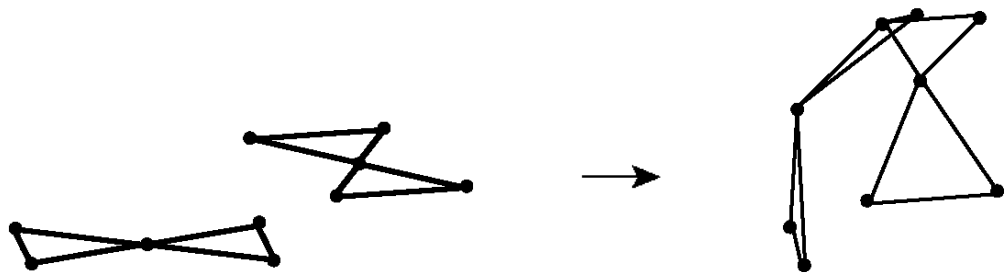

(8)

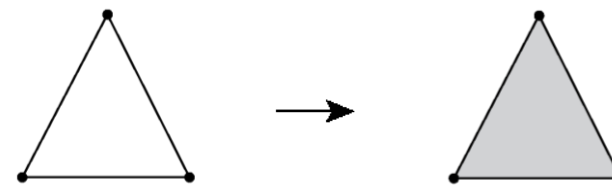

ΠΑΡΑΔΕΙΓΜΑ ΕΦΑΡΜΟΓΗΣ ΚΑΝΟΝΑ 7

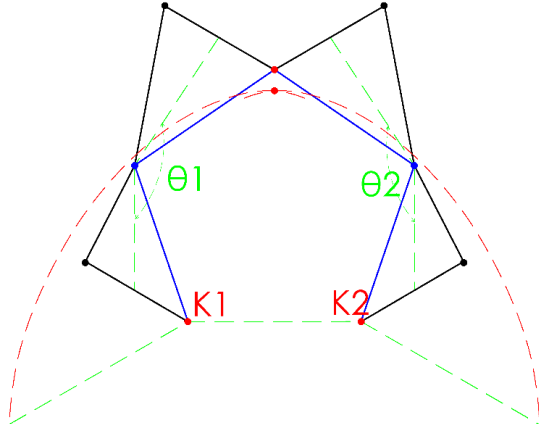
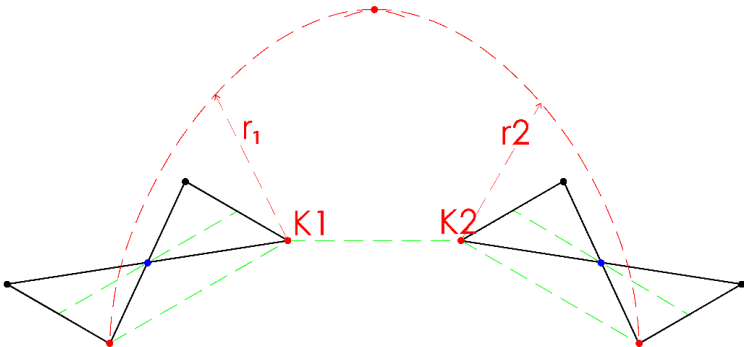
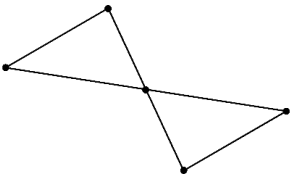
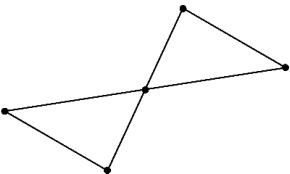

# ΠΑΡΑΔΕΙΓΜΑ ΠΑΡΑΓΩΓΗΣ ΣΚΗΝΗΣ

ΑΡΧΙΚΟ ΣΧΗΜΑ

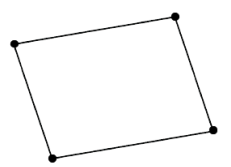

1

ΡΑΒΔΟΙ

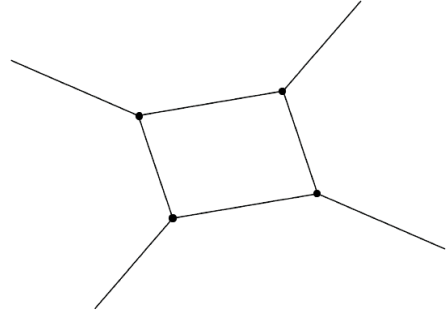

2

ΕΝΩΣΗ

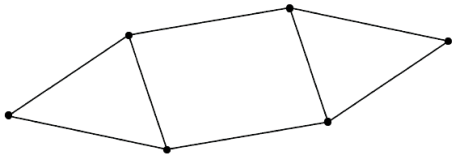

5

ΓΕΦΥΡΩΣΗ

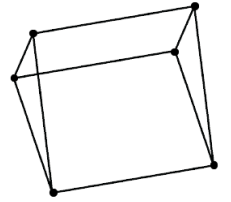

8

ΠΛΗΡΩΣΗ

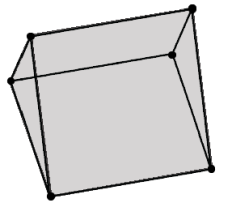

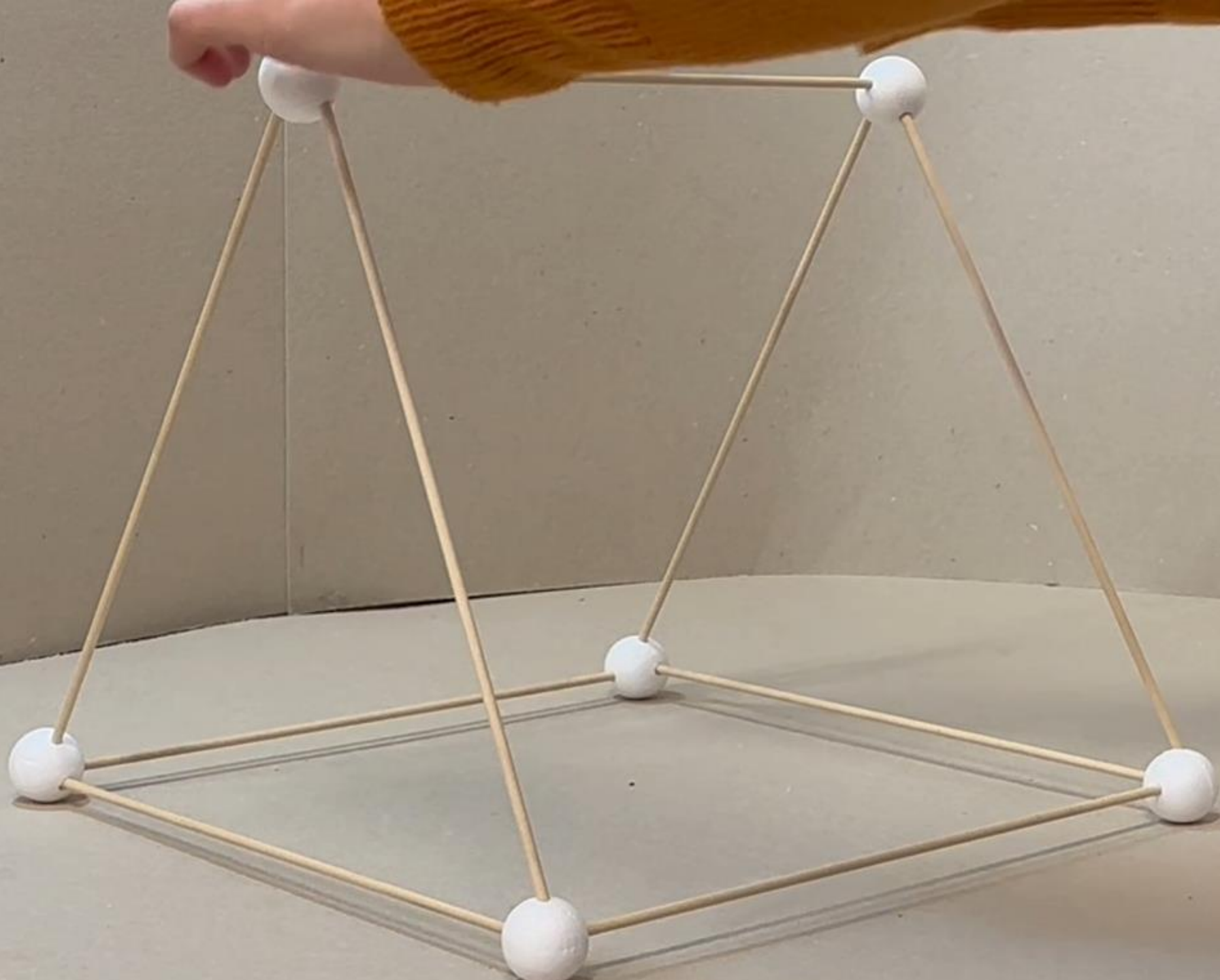

## 4. Κατασκευή Καταλυμάτων Πρώτης Βοήθειας

ΚΑΝΟΝΕΣ ΚΑΤΑΣΚΕΥΑΣΤΙΚΩΝ ΣΤΟΙΧΕΙΩΝ

(9)

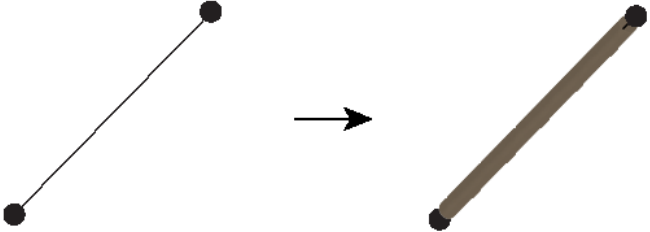

(11)

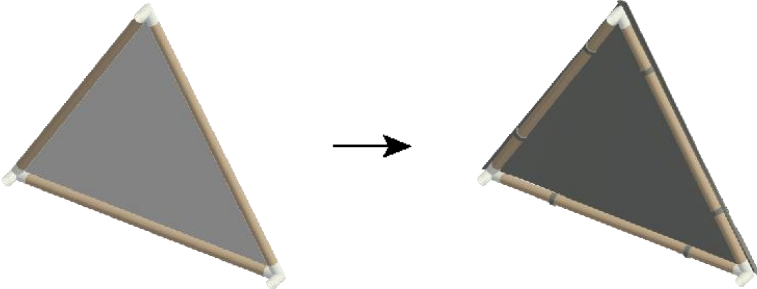

(10)

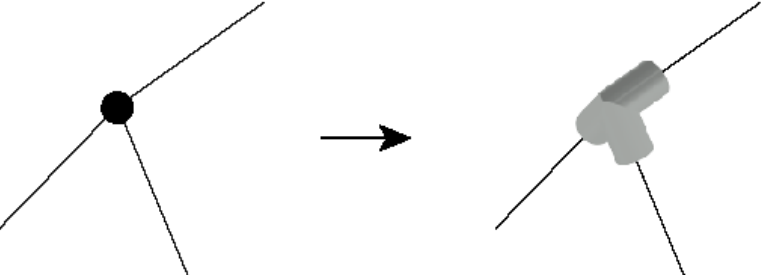

(12)

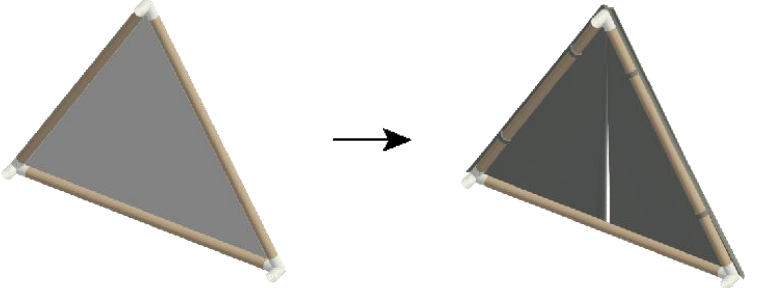

ΠΑΡΑΔΕΙΓΜΑ ΠΑΡΑΓΩΓΗΣ ΣΚΗΝΗΣ

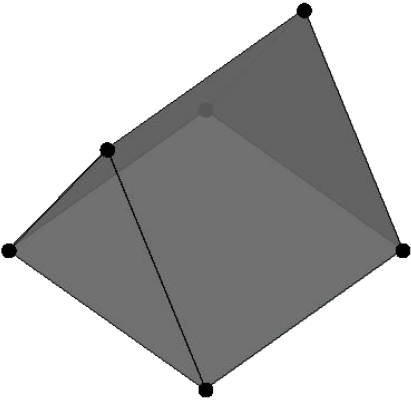

9  
⇒

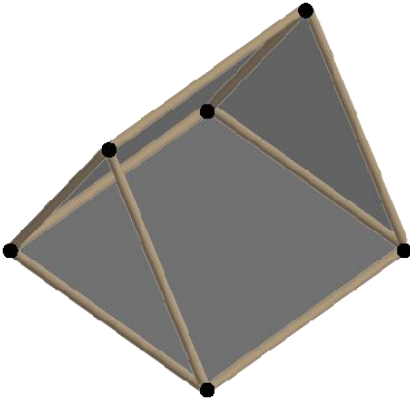

10  
⇒

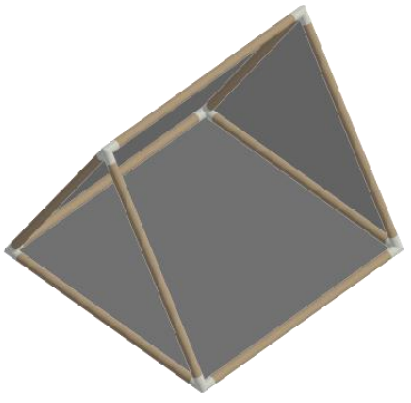

11  
12  
⇒

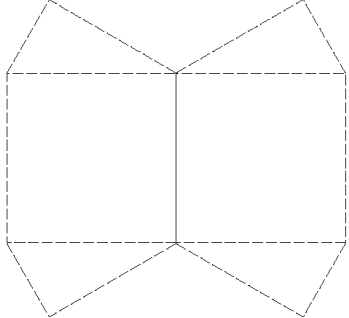
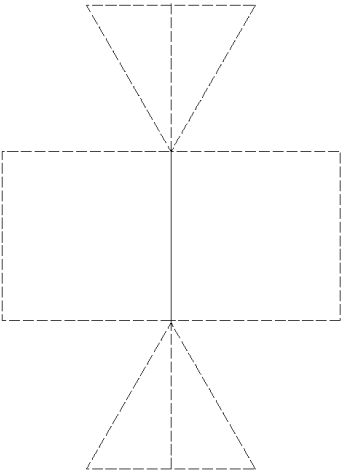
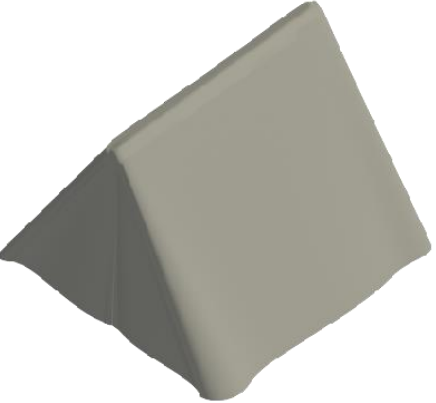



## 5. Χωροθέτηση Καταλυμάτων Πρώτης Βοήθειας



# ΧΩΡΟΘΕΤΗΣΗ ΠΡΩΤΗΣ ΑΝΑΓΚΗΣ

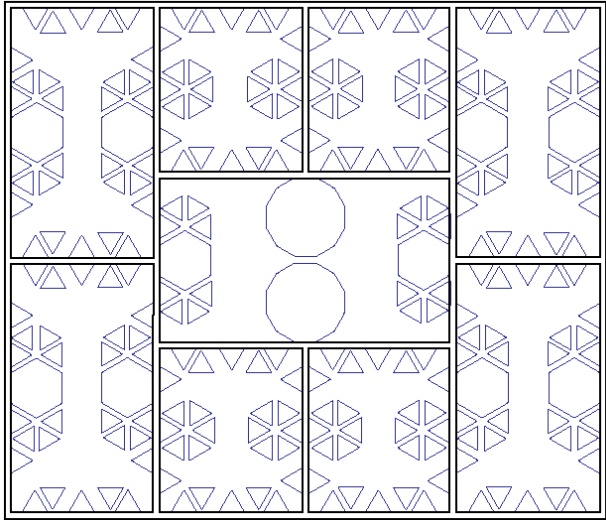

Κατωφερής  
(top-down)

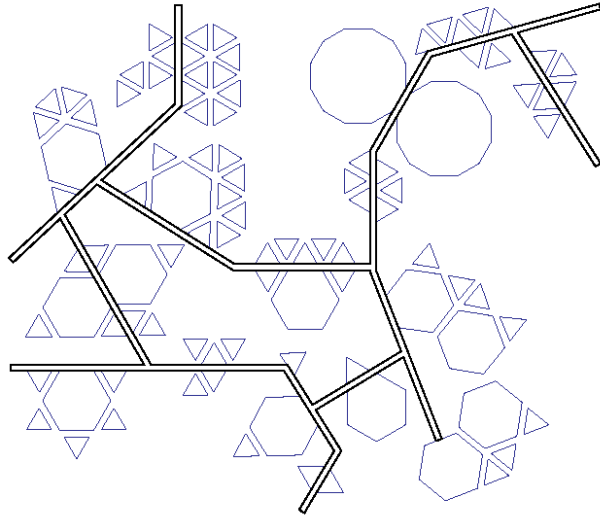

Ανωφερής  
(bottom-up)

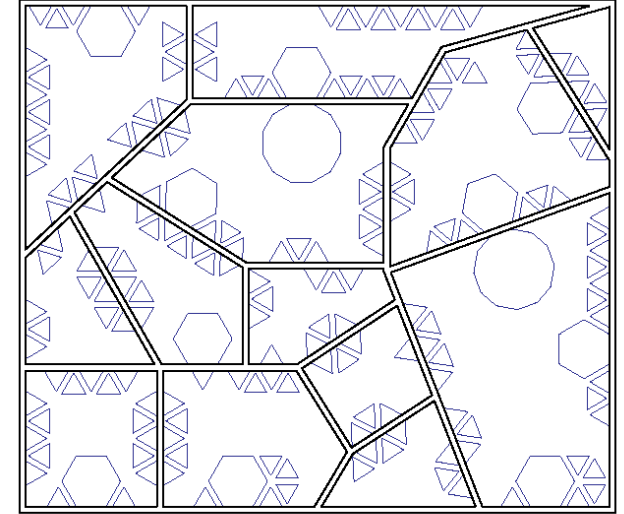
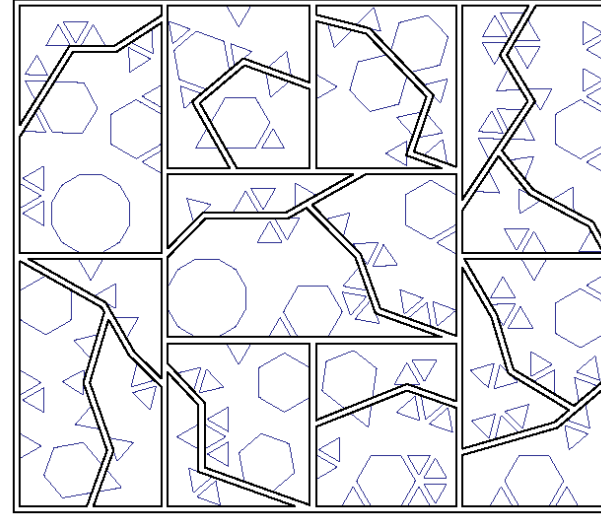

Συνδυασμός

# ΠΑΡΑΔΕΙΓΜΑ ΧΩΡΟΘΕΤΗΣΗΣ

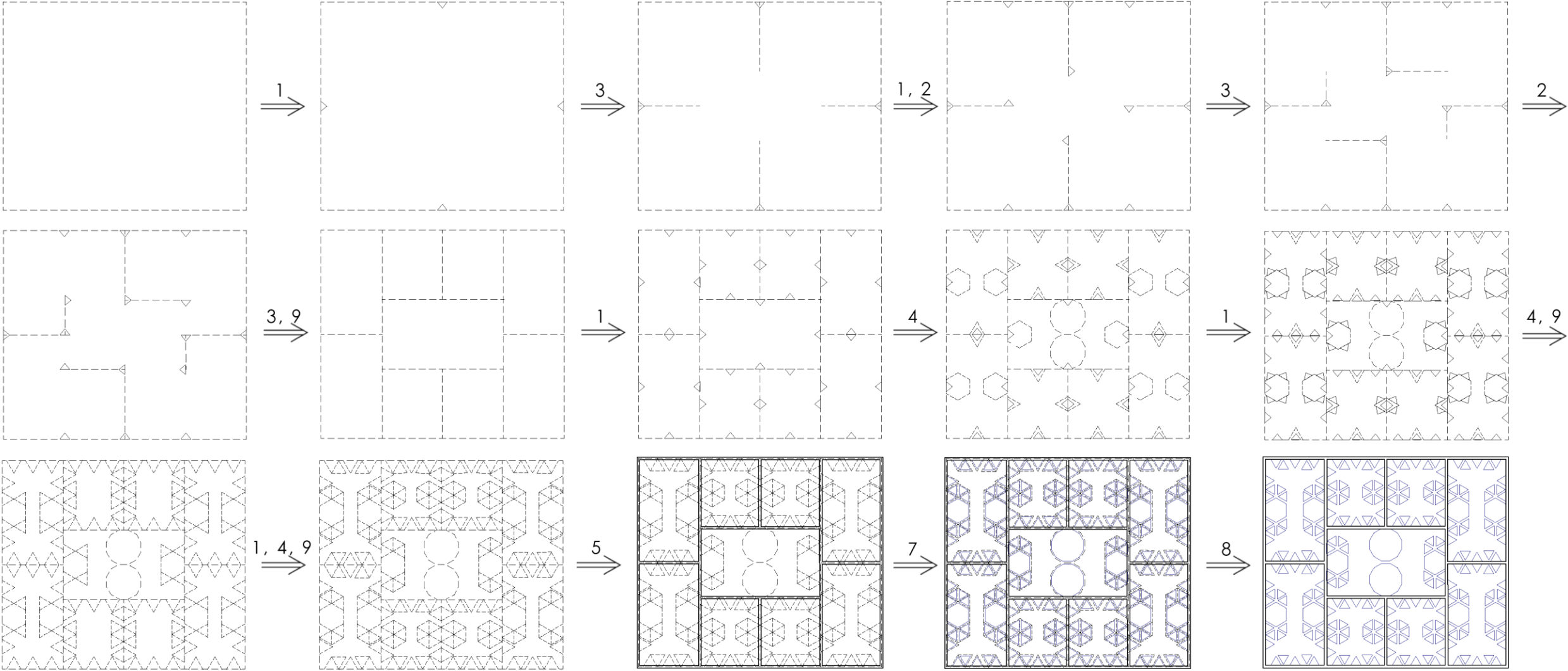

(1)

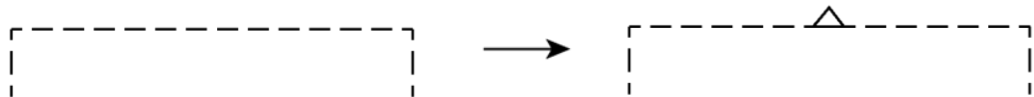

(3)



(2)

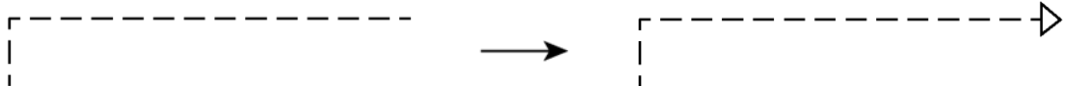

(4)

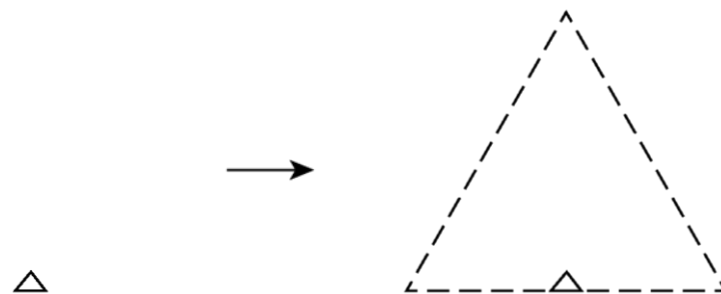

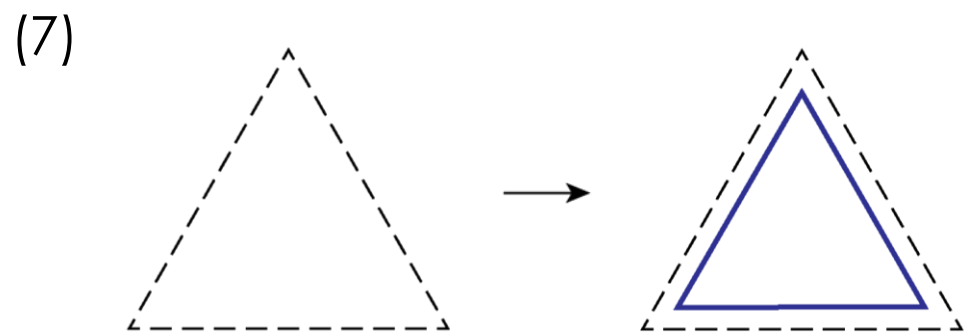
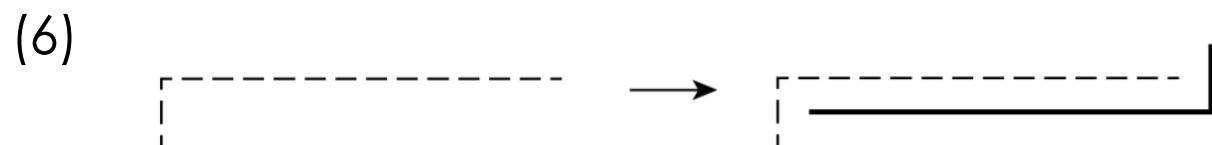
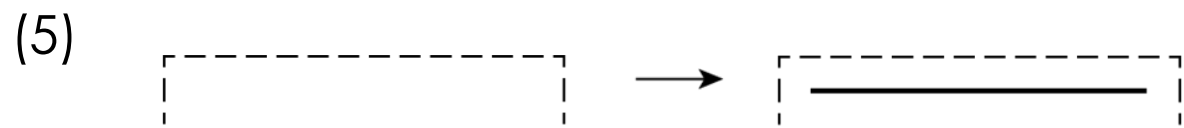

# ΑΞΙΟΛΟΓΗΣΗ

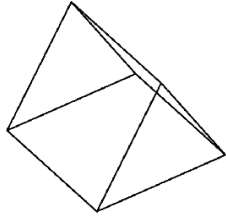
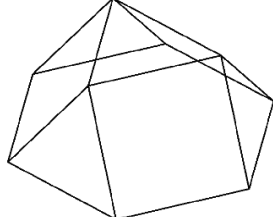
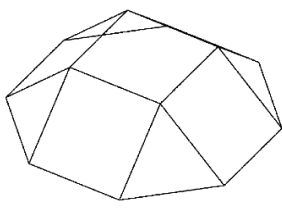
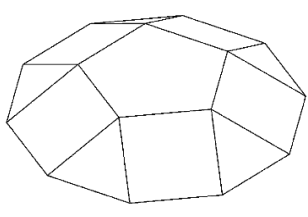
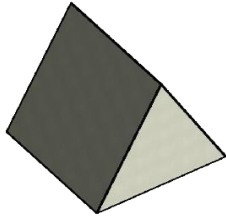
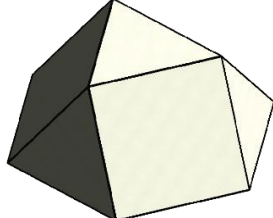
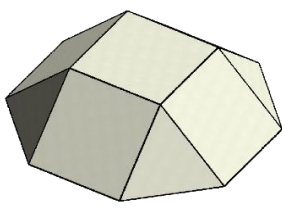
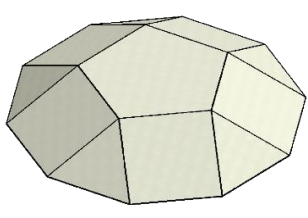
$u \backslash v$	4-γωνο	6-γωνο	8-γωνο	10-γωνο
$U_{13}$				
$U_{13} \times U_{23}$				

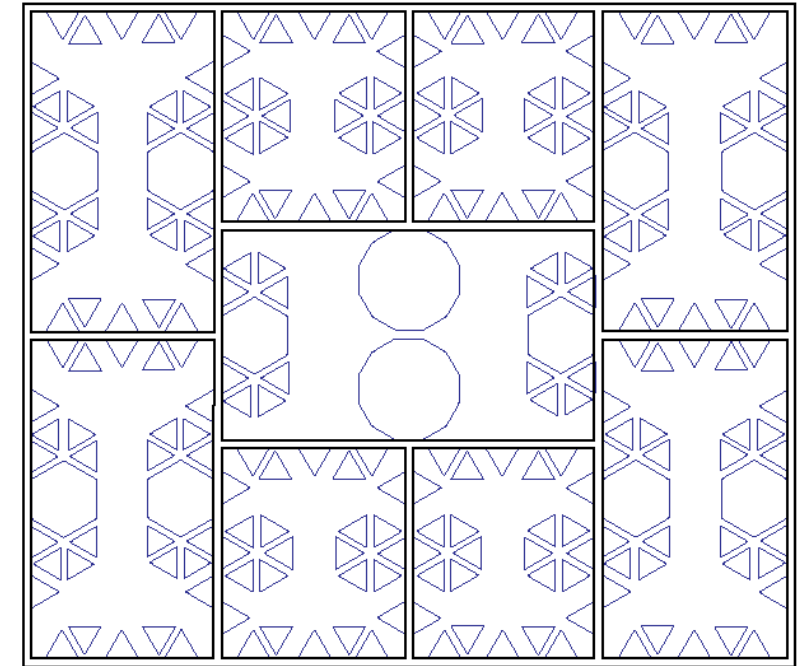
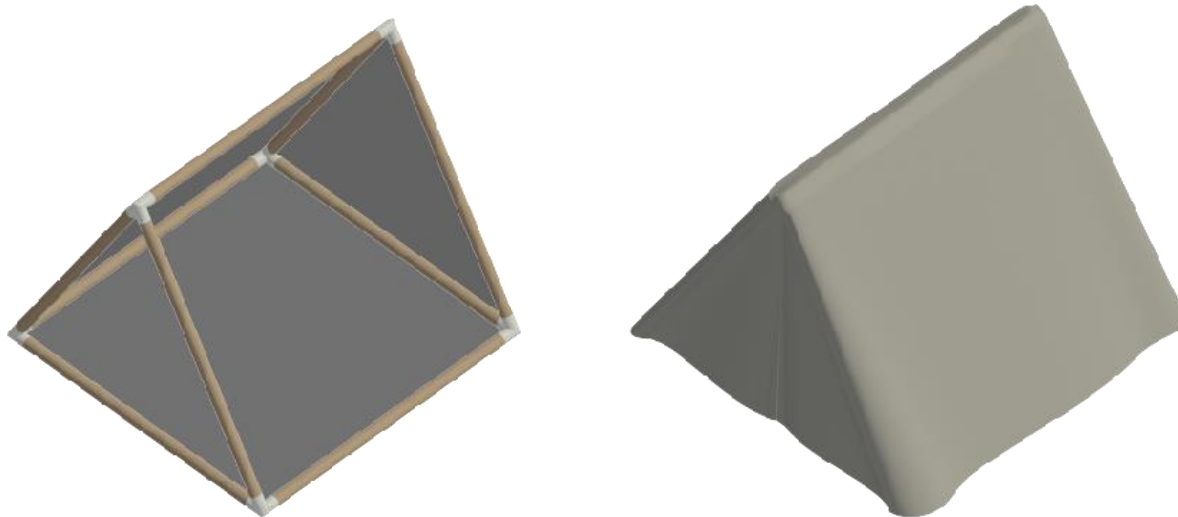

## 6. Σχεδιασμός Καταλυμάτων Επανάστασης



# Temporary housing scheme for displaced Ukrainians, Balbek Bureau (2022)



# Temporary housing scheme for displaced Ukrainians, Balbek Bureau (2022)

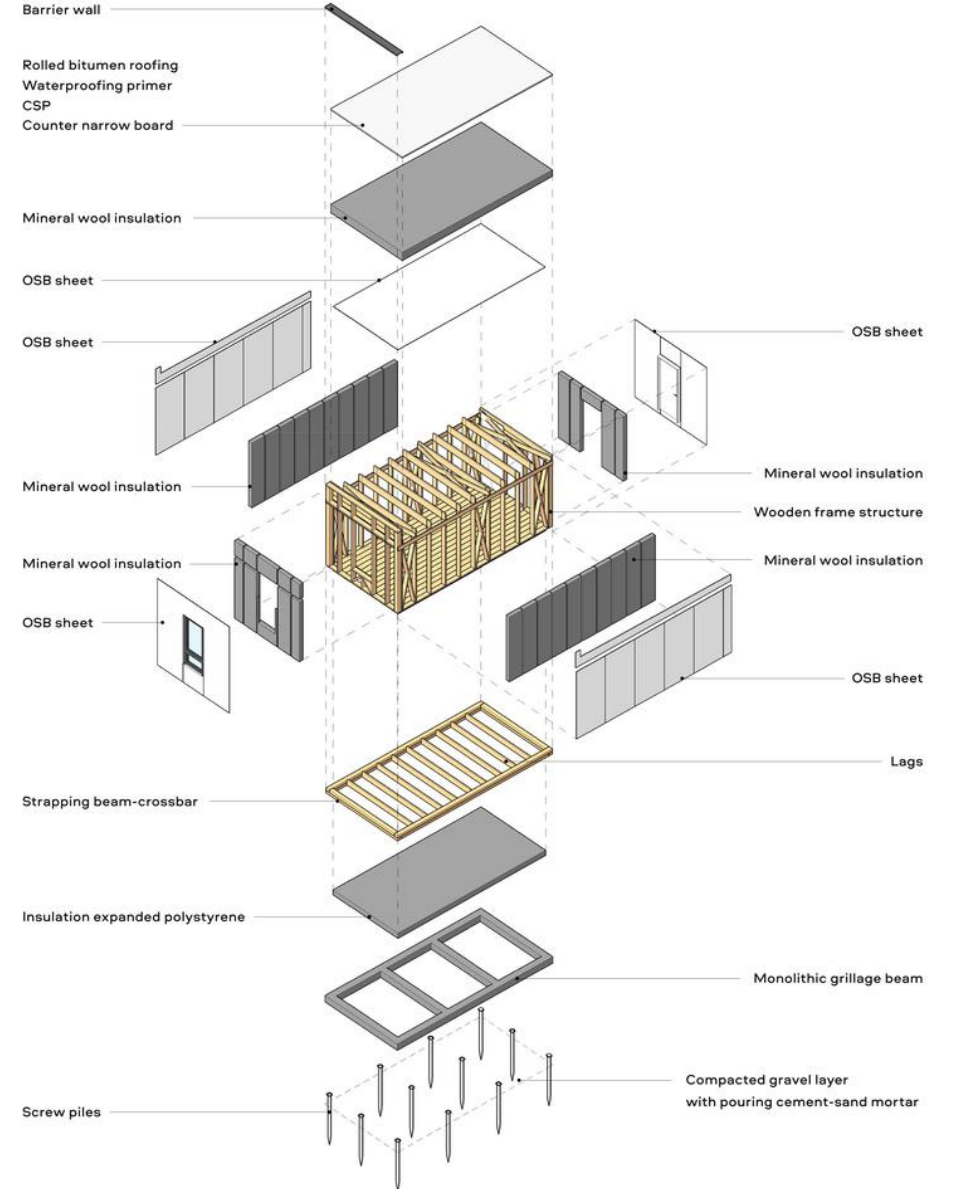
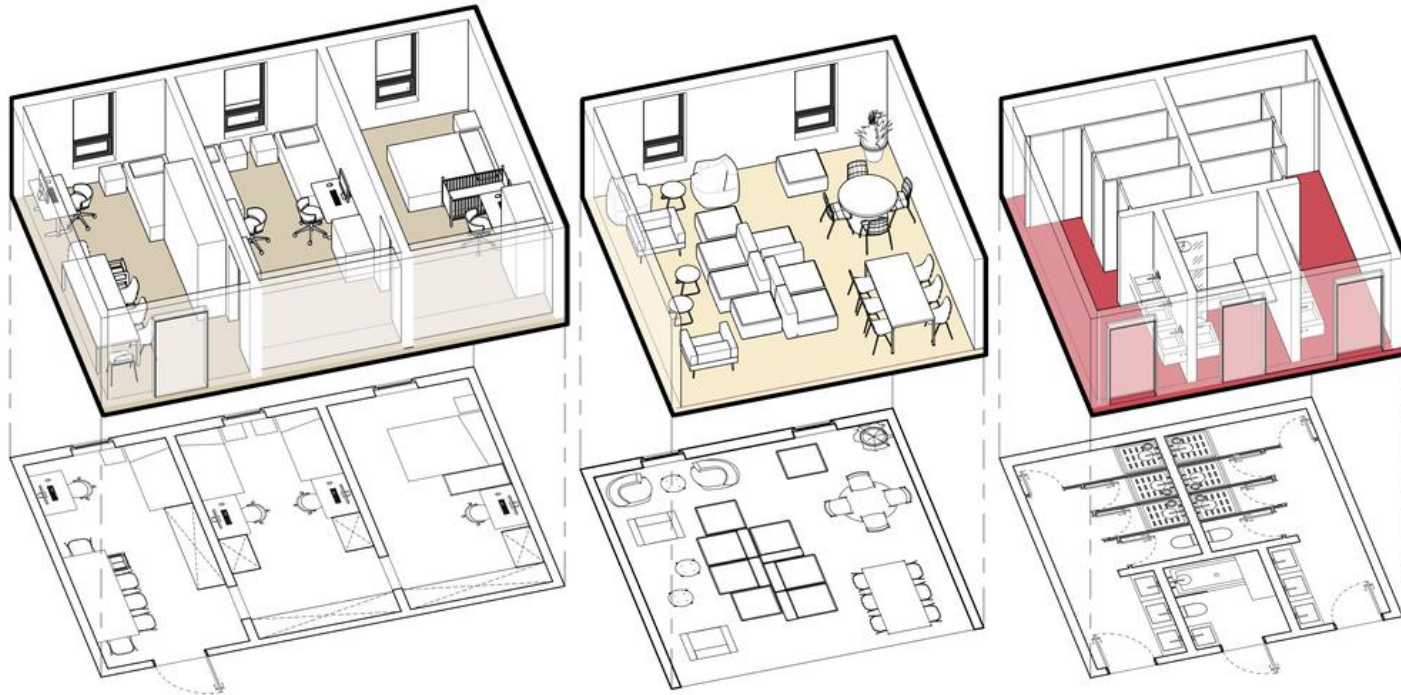

# ΠΑΡΑΔΕΙΓΜΑΤΑ ΒΑΣΙΚΩΝ ΚΑΤΑΛΥΜΑΤΩΝ

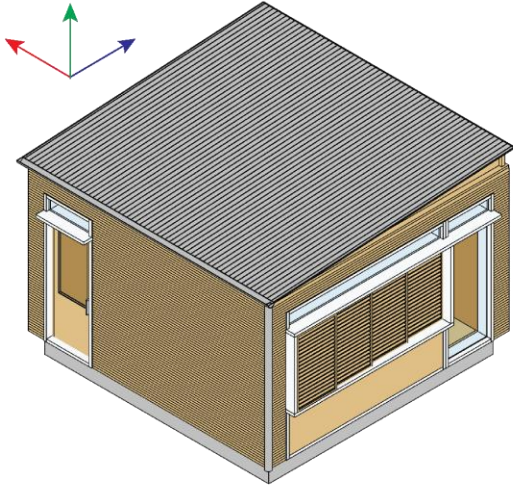

ΕΛΑΧΙΣΤΗ ΜΟΝΑΔΑ

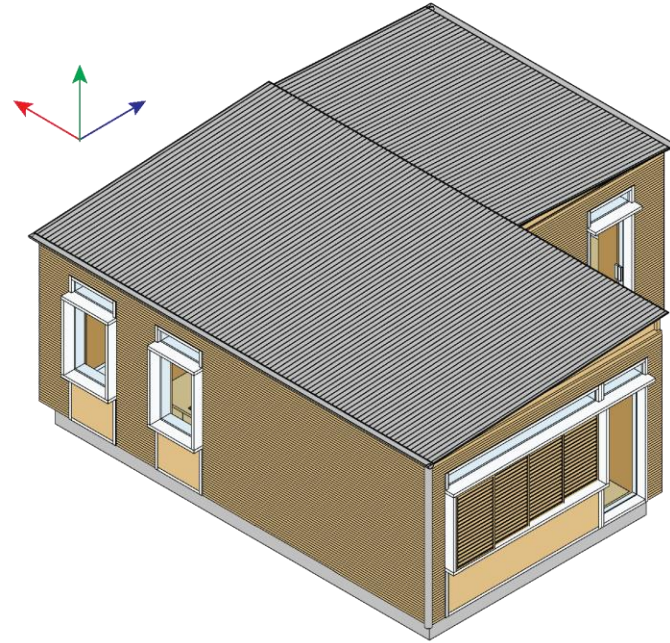

ΕΝΔΙΑΜΕΣΗ ΜΟΝΑΔΑ

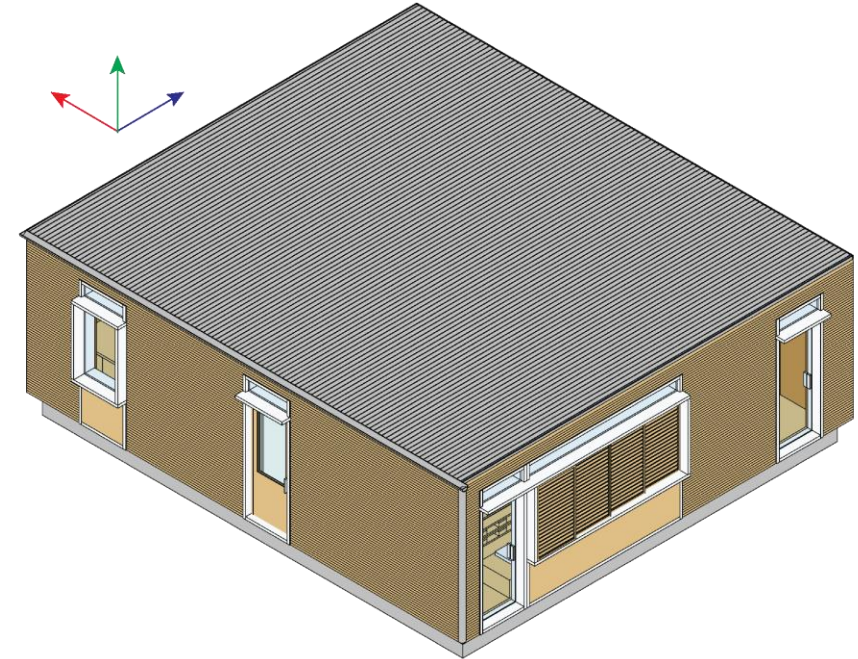

ΜΕΓΙΣΤΗ ΜΟΝΑΔΑ

# ΣΥΝΑΡΜΟΛΟΓΗΣΗ ΠΡΟΚΑΤΑΣΚΕΥΑΣΜΕΝΩΝ ΣΤΟΙΧΕΙΩΝ



# ΠΑΡΑΔΕΙΓΜΑΤΑ ΒΑΣΙΚΩΝ ΚΑΤΑΛΥΜΑΤΩΝ

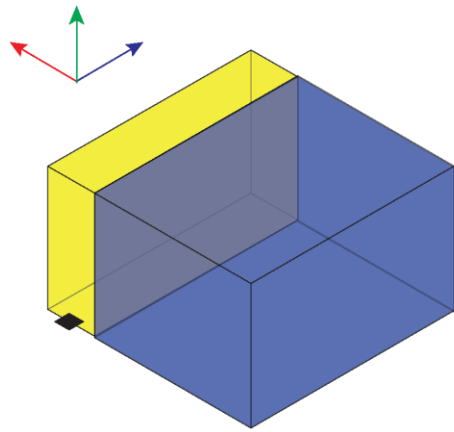

ΕΛΑΧΙΣΤΗ ΜΟΝΑΔΑ

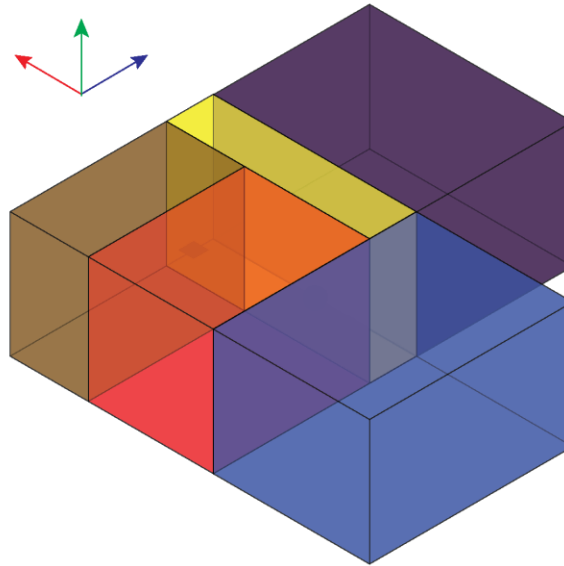

ΕΝΔΙΑΜΕΣΗ ΜΟΝΑΔΑ

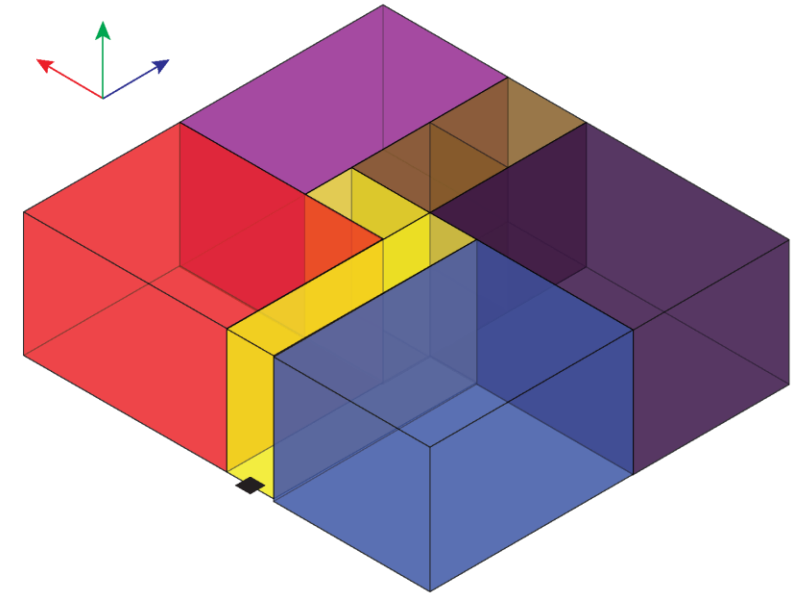

ΜΕΓΙΣΤΗ ΜΟΝΑΔΑ

- Καθιστικό
- Χώρος Κουζίνας
- Χώρος Υγιεινής
- Οργάνωση κίνησης
- Κυρίως Υπνοδωμάτιο
- Παιδικό Υπνοδωμάτιο

# Διαμόρφωση κάτοψης

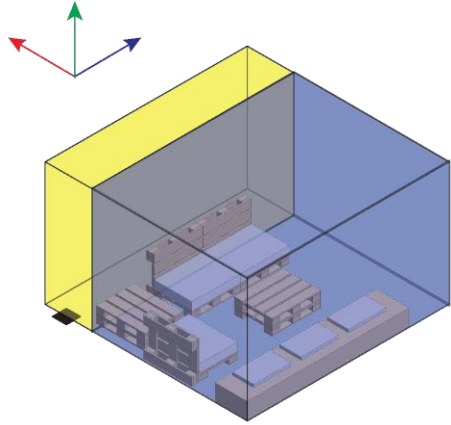

ΕΛΑΧΙΣΤΗ ΜΟΝΑΔΑ

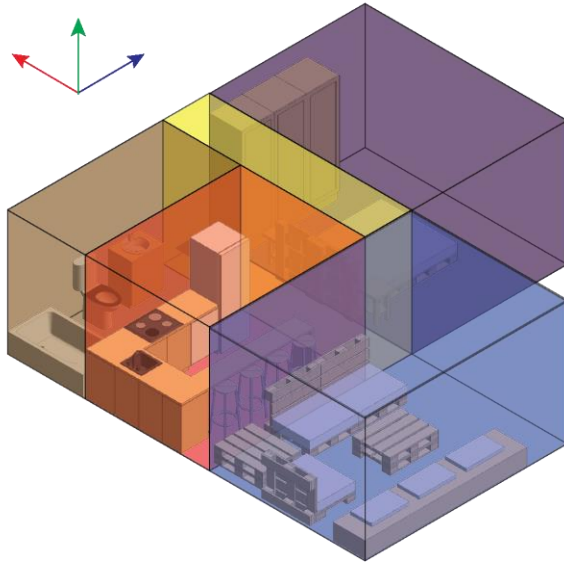

ΕΝΔΙΑΜΕΣΗ ΜΟΝΑΔΑ

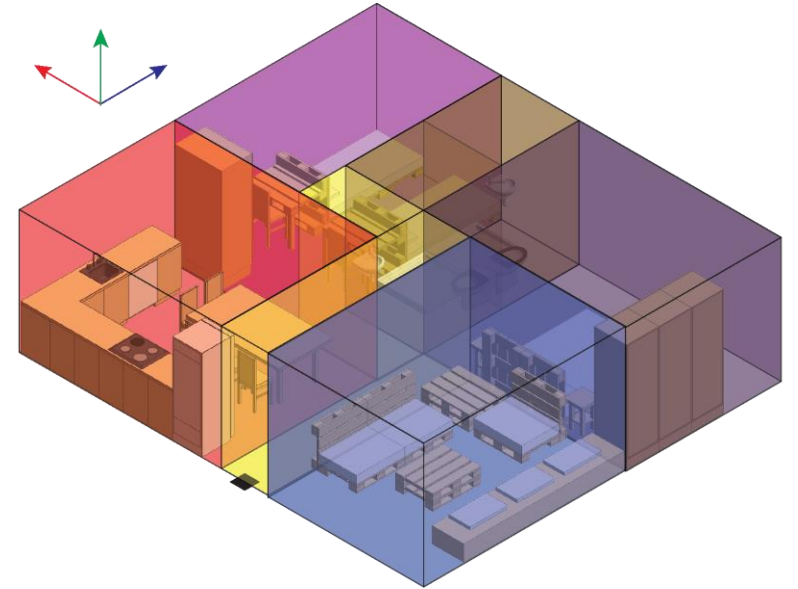

ΜΕΓΙΣΤΗ ΜΟΝΑΔΑ

- Καθιστικό
- Χώρος Κουζίνας
- Χώρος Υγιεινής
- Οργάνωση κίνησης
- Κυρίως Υπνοδωμάτιο
- Παιδικό Υπνοδωμάτιο

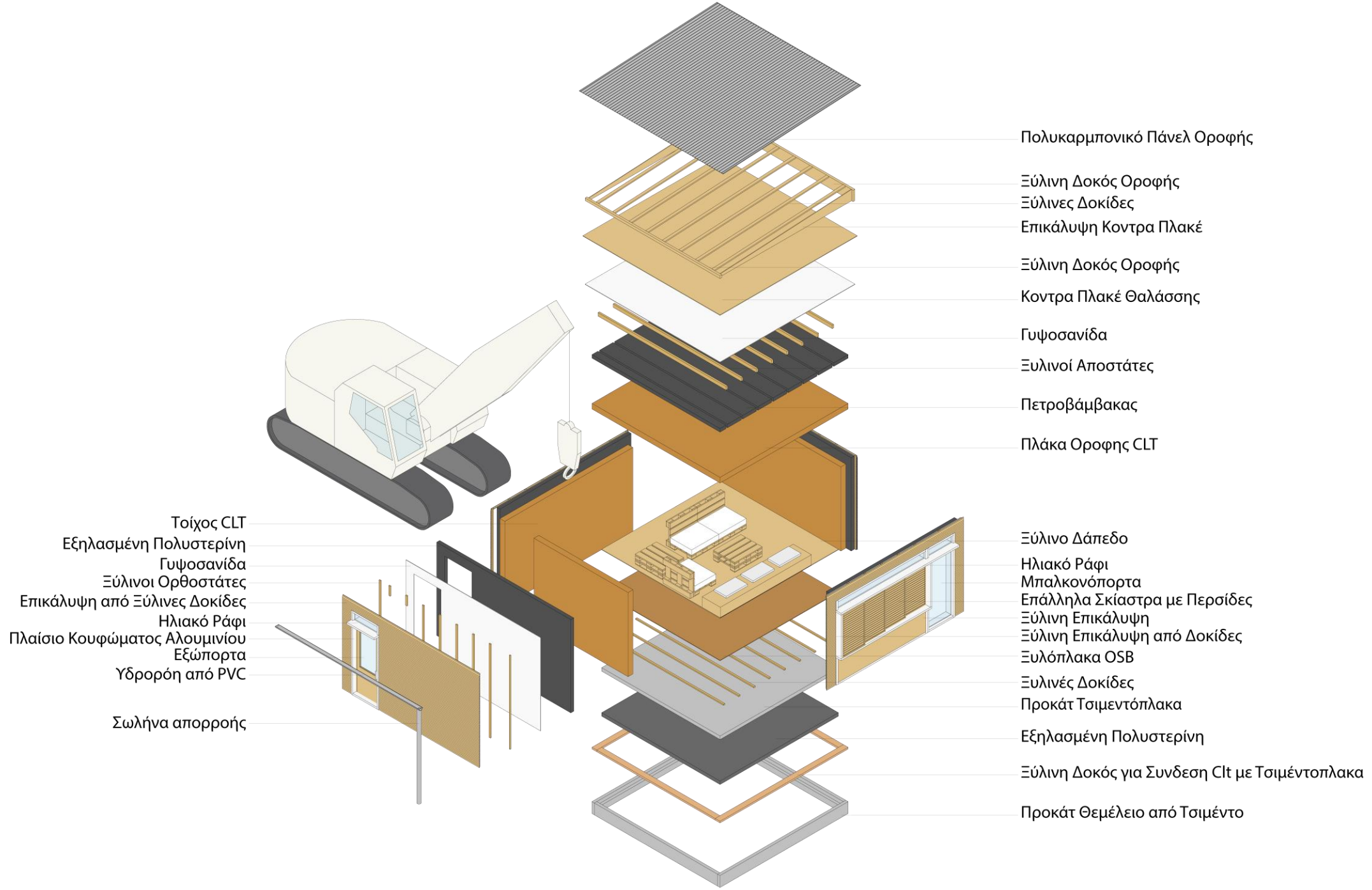

Πολυκαρμπονικό Πάνελ Οροφής

Ξύλινη Δοκός Οροφής  
Ξύλινες Δοκίδες  
Επικάλυψη Κοντρα Πλακέ

Ξύλινη Δοκός Οροφής  
Κοντρα Πλακέ Θαλάσσης

Γυψοσανίδα  
Ξυλινοί Αποστάτες

Πετροβάμβακας

Πλάκα Οροφής CLT

Ξύλινο Δάπεδο  
Ηλιακό Ράφι  
Μπαλκονόπορτα  
Επάλληλα Σκίαστρα με Περισίδες  
Ξύλινη Επικάλυψη  
Ξύλινη Επικάλυψη από Δοκίδες  
Ξυλόπλακα OSB

Ξυλινές Δοκίδες  
Προκάτ Τσιμεντόπλακα  
Εξηλασμένη Πολυστερίνη

Ξύλινη Δοκός για Συνδεση Clt με Τσιμέντοπλακα

Προκάτ Θεμέλιο από Τσιμέντο

Τοίχος CLT  
Εξηλασμένη Πολυστερίνη  
Γυψοσανίδα  
Ξύλινοι Ορθοστάτες  
Επικάλυψη από Ξύλινες Δοκίδες  
Ηλιακό Ράφι  
Πλαίσιο Κουφώματος Αλουμινίου  
Εξώπορτα  
Υδρορόη από PVC  
Σωλήνα απορροής

ΟΓΚΟΠΛΑΣΤΙΚΟ ΔΩΜΑΤΙΟΥ

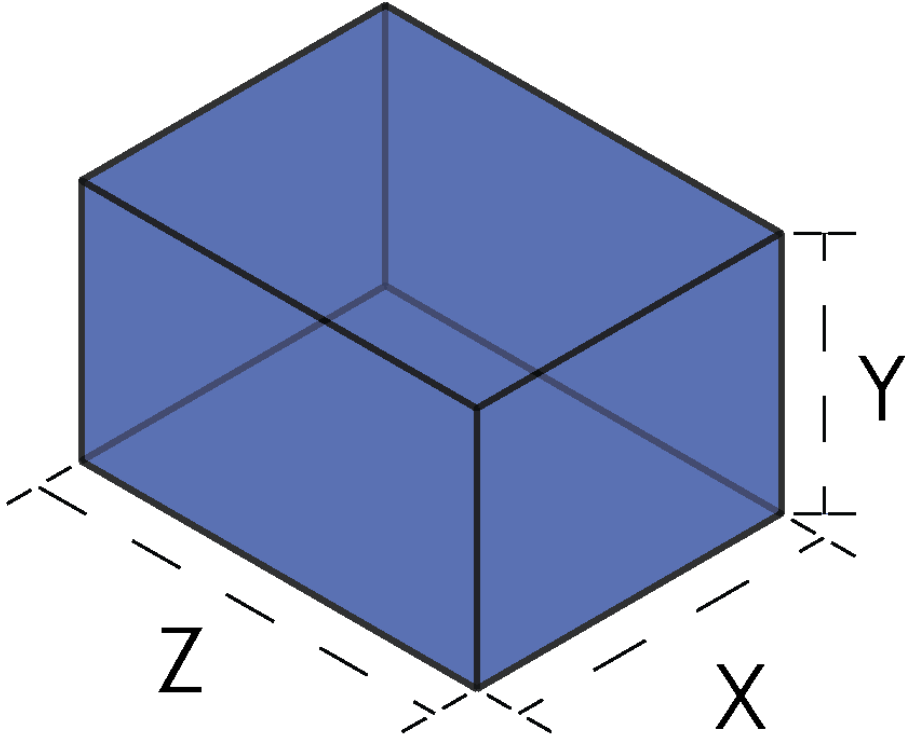



# ΧΩΡΙΚΟ ΛΕΞΙΛΟΓΙΟ ΔΩΜΑΤΙΩΝ

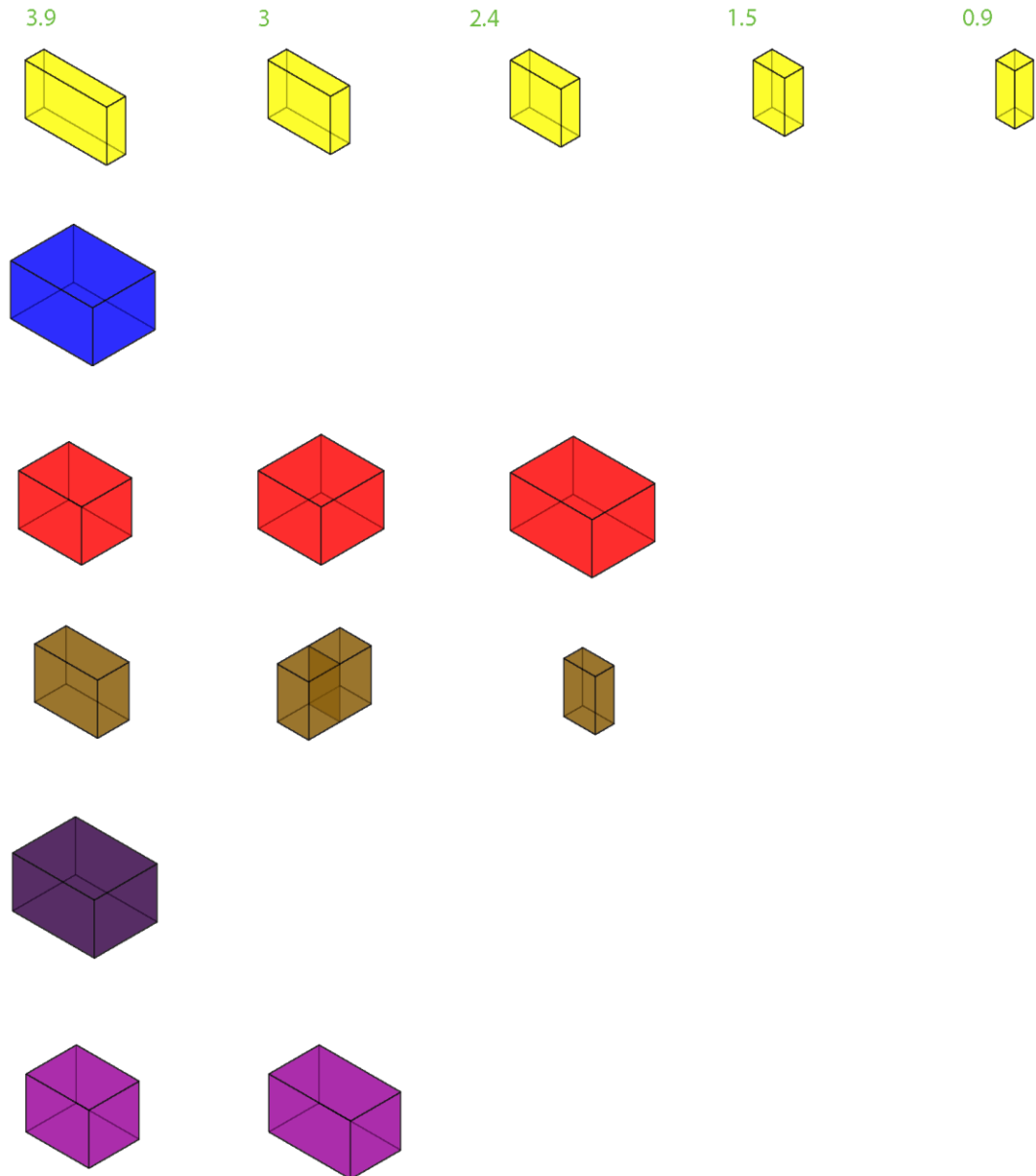

- Καθιστικό
- Χώρος Κουζίνας
- Χώρος Υγιεινής
- Οργάνωση κίνησης
- Κυρίως Υπνοδωμάτιο
- Παιδικό Υπνοδωμάτιο

# ΑΡΧΙΚΟ ΣΧΗΜΑ - ΕΙΣΟΔΟΣ ΚΑΙ ΠΡΟΣΑΝΑΤΟΛΙΣΜΟΣ



# Παράδειγμα 1

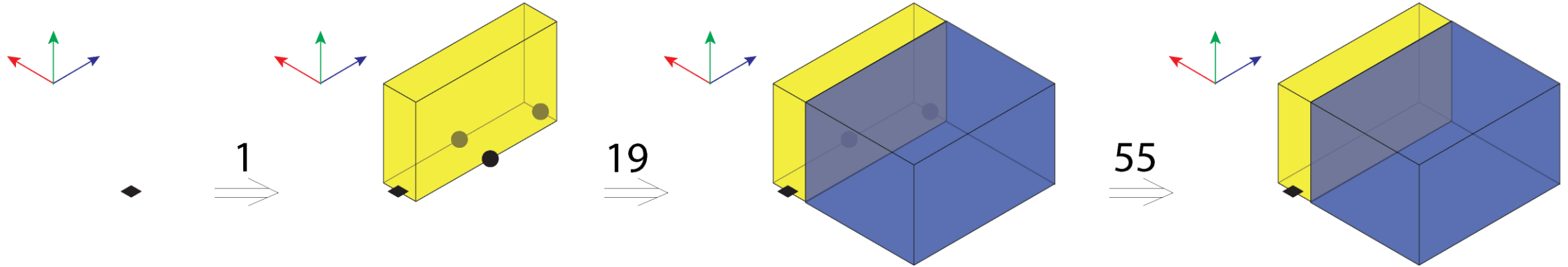

# Παράδειγμα 2

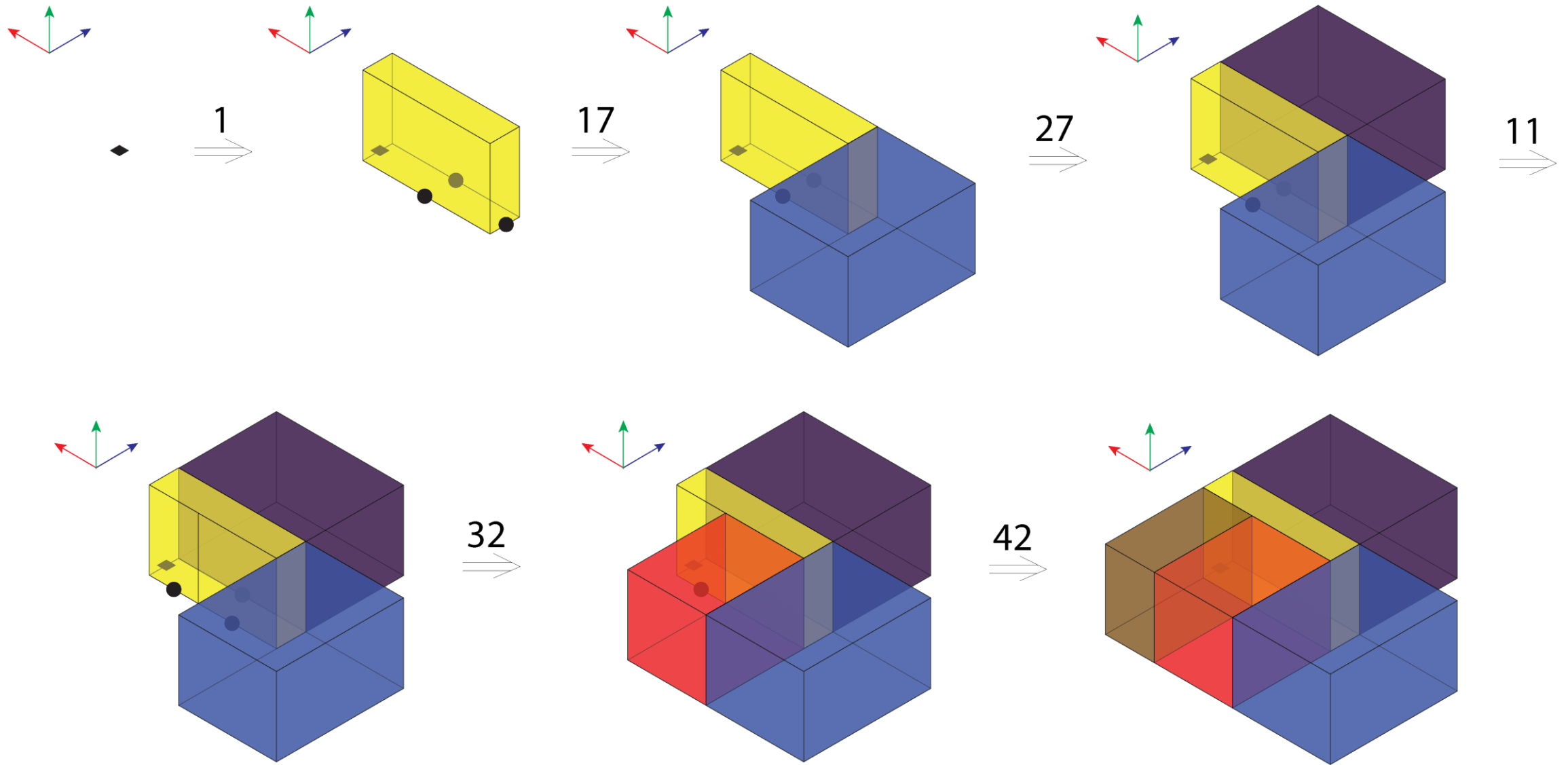

# Παράδειγμα 3

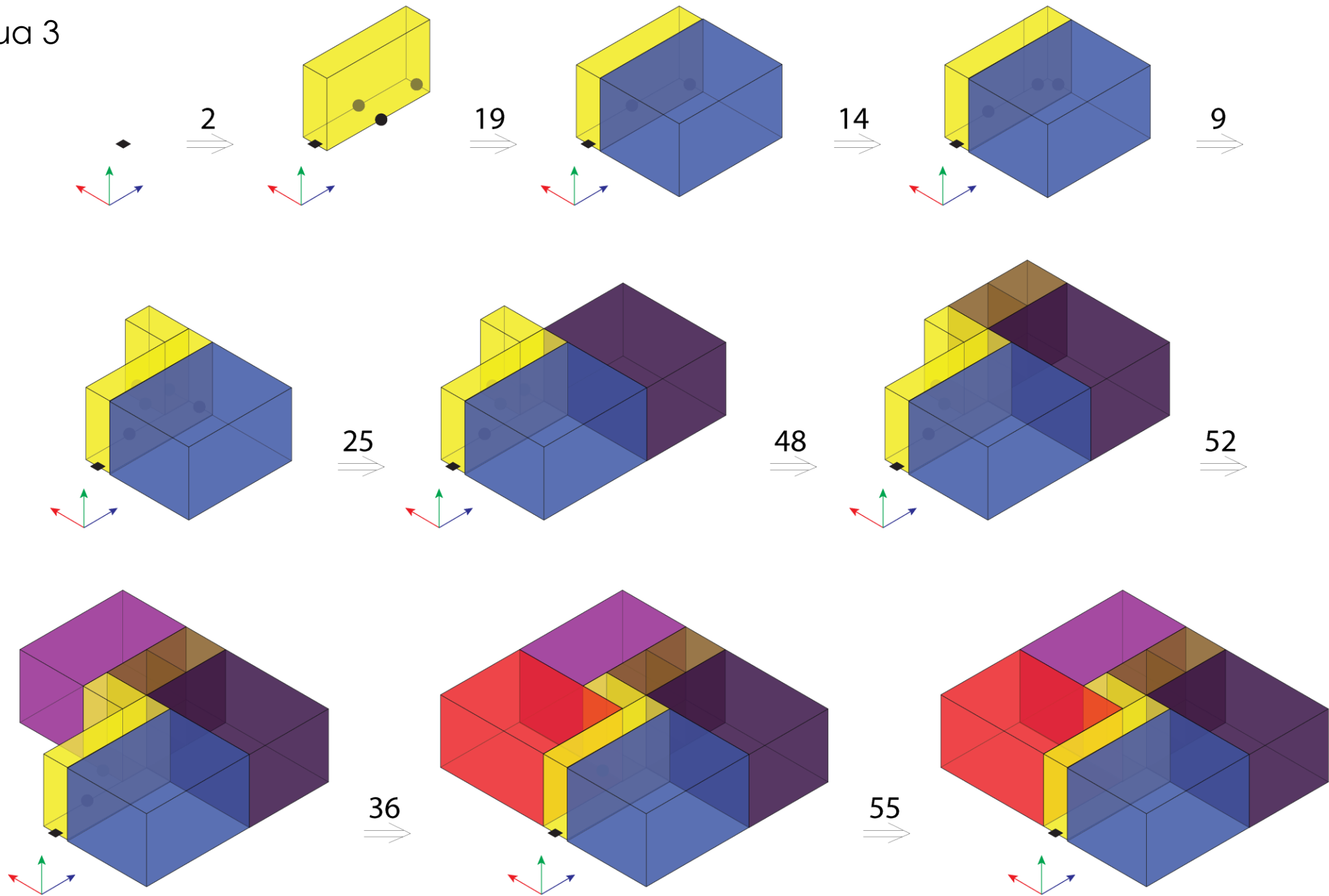

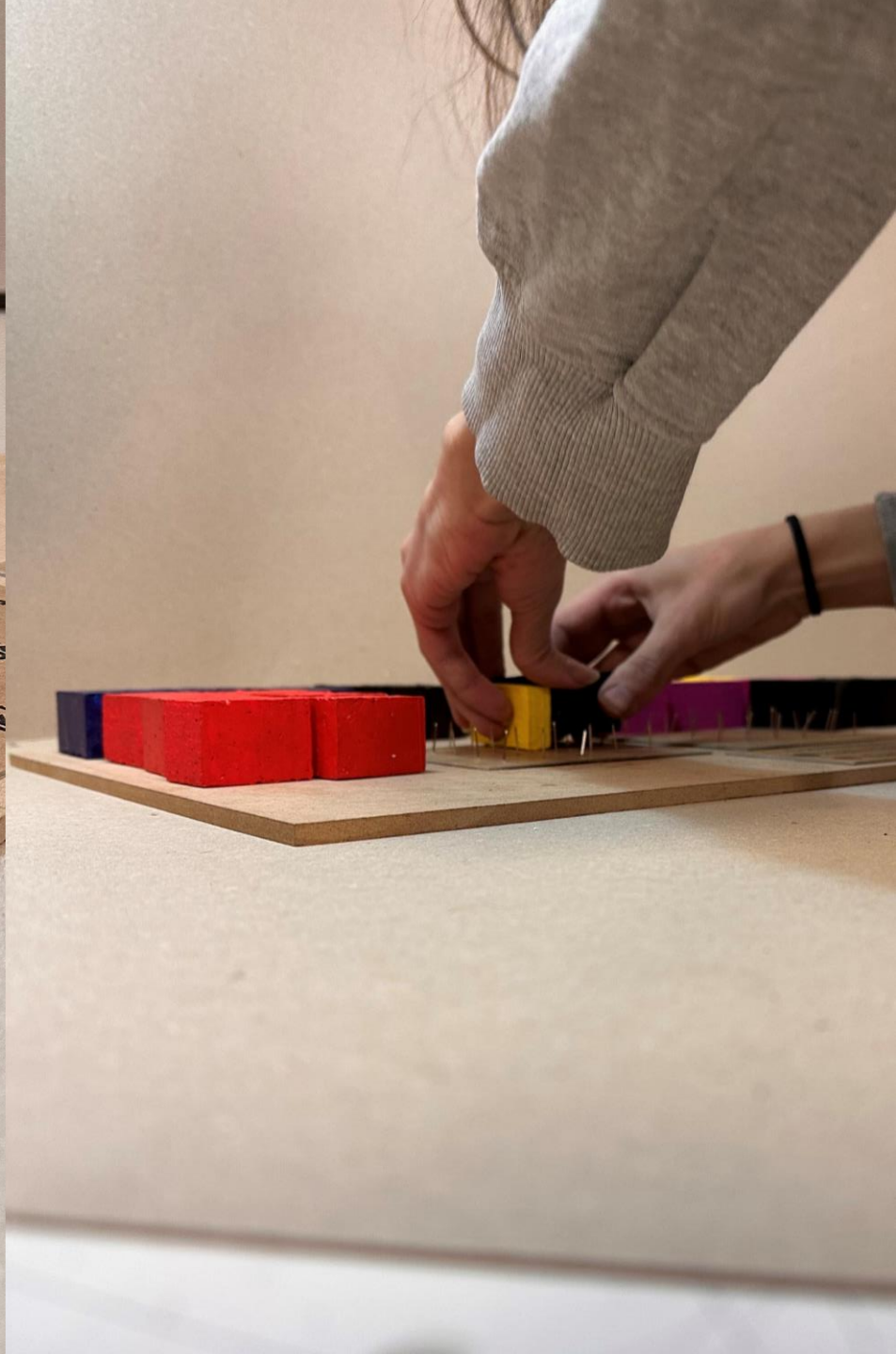
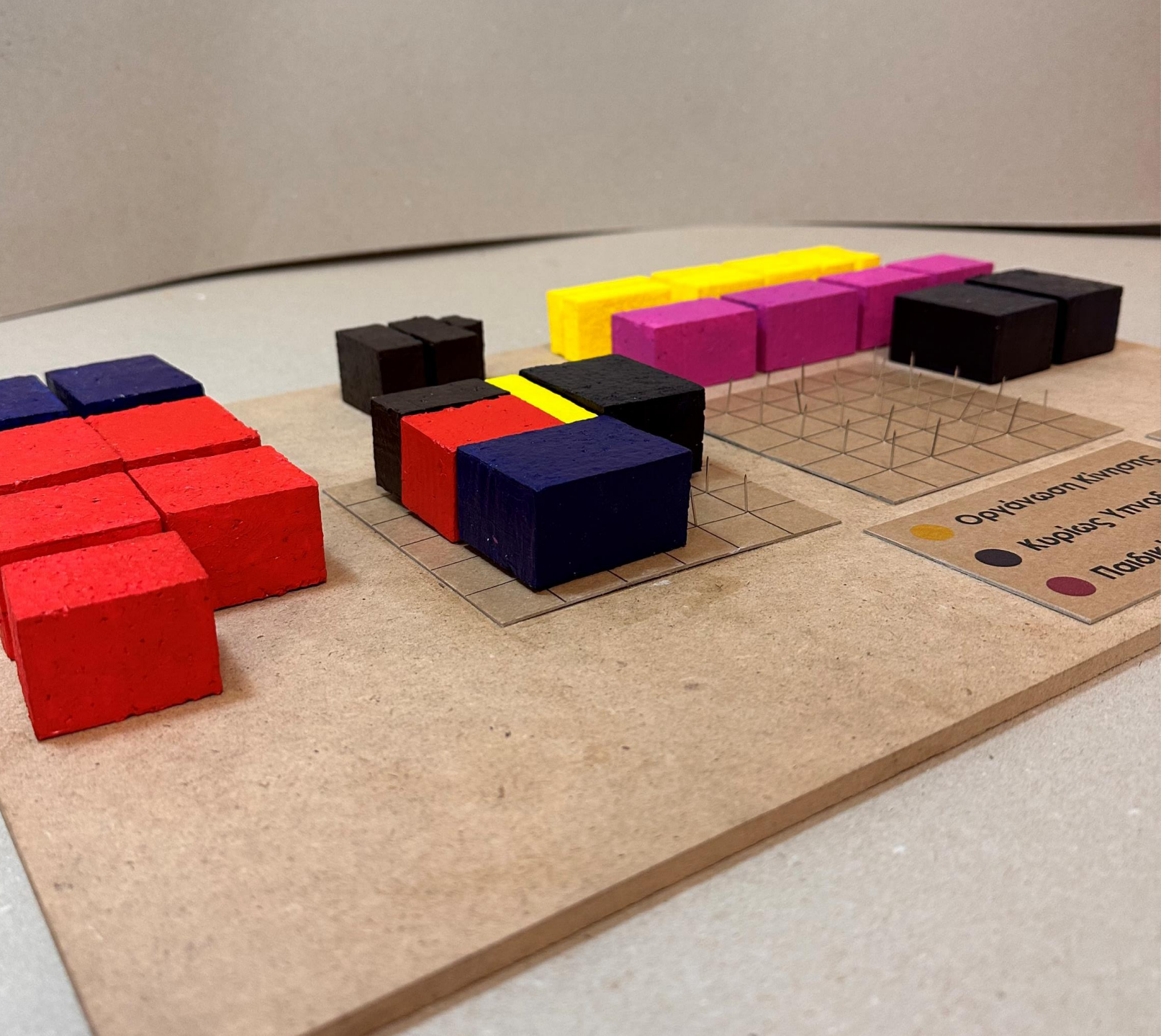

# Κανόνες Βασικού Άξονα

## Αρχικοί Κανόνες:

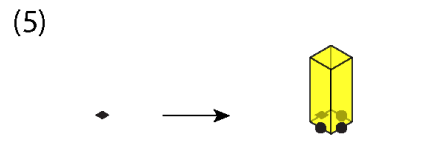
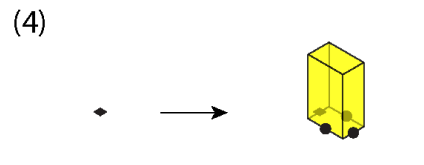
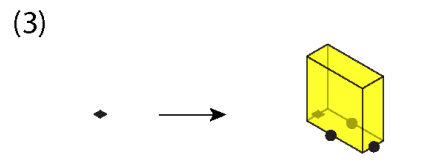
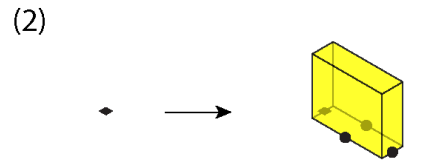
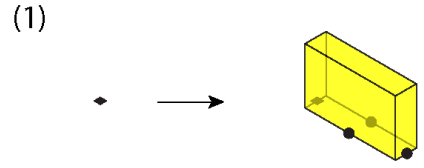

## Προσθετικοί Κανόνες

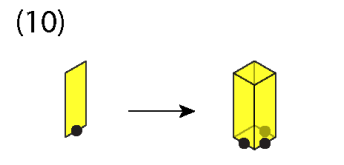
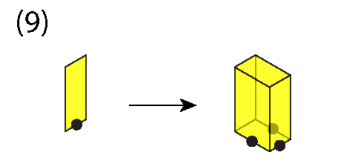
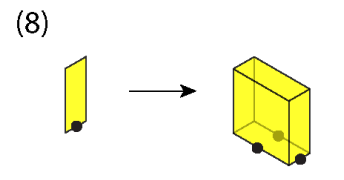
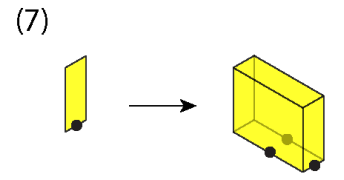
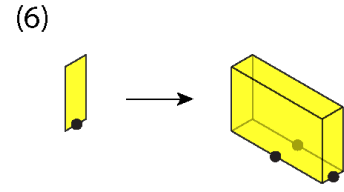

## Διαιρητικοί Κανόνες

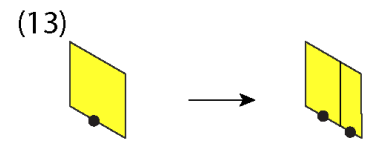
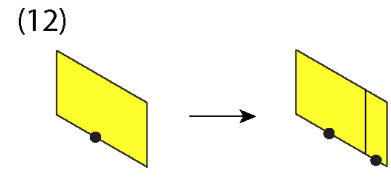
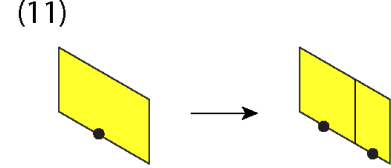

## Αθροιστικοί Κανόνες

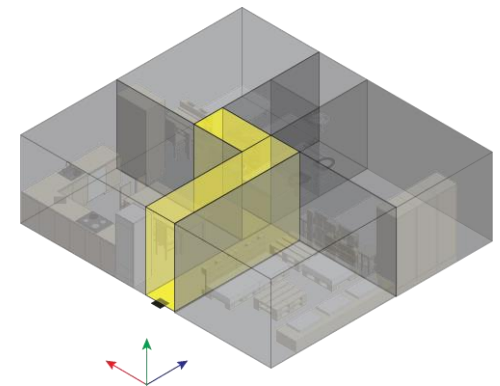
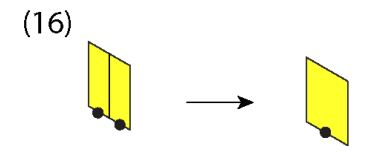
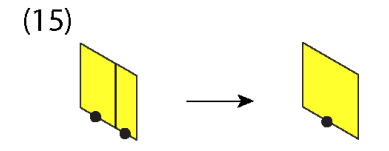
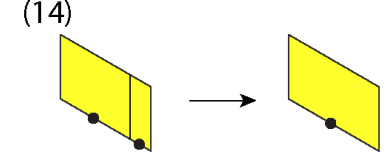

# Κανόνες Καθιστικού

(17)

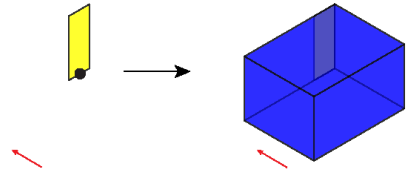

(21)

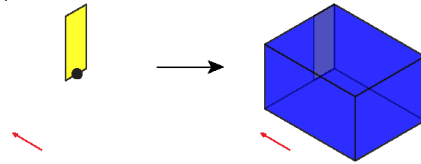

(18)

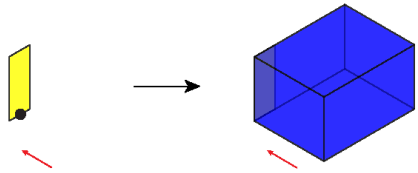

(22)

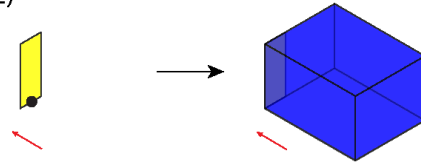

(19)

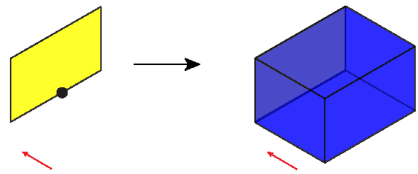

(23)

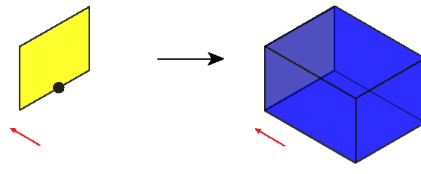

(20)

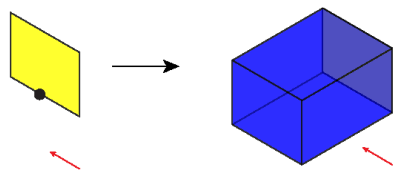

(24)

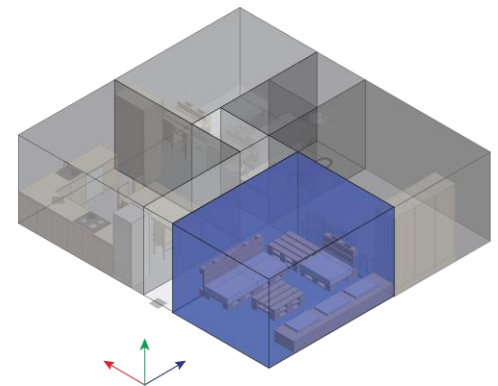
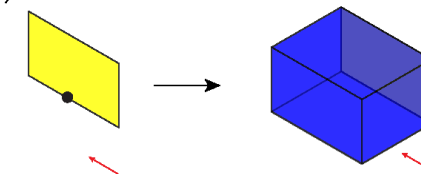



# Κυρίως υπνοδωμάτιο

(25)

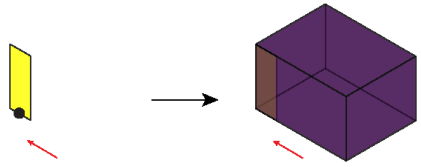

(28)

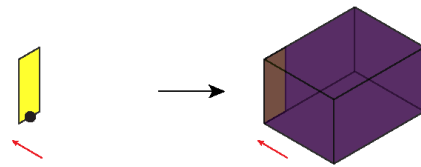

(26)

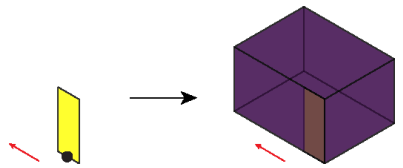

(29)

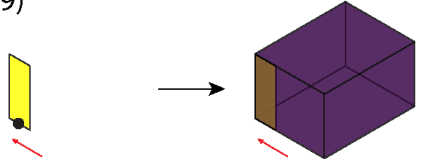

(27)

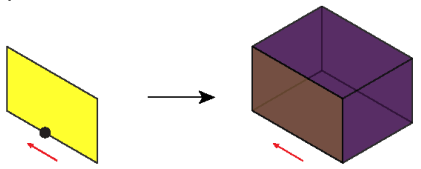

(30)

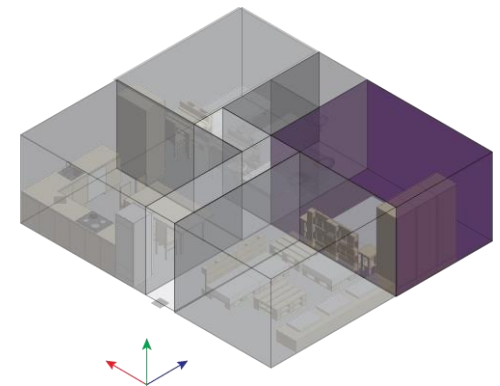
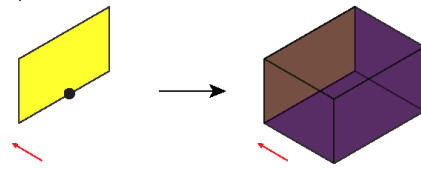

# Κανόνες Κουζίνας

(31)

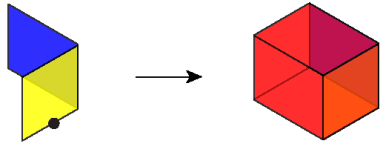

(32)

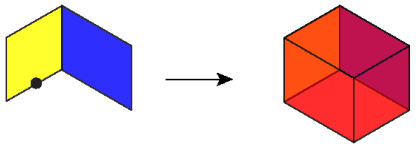

(33)

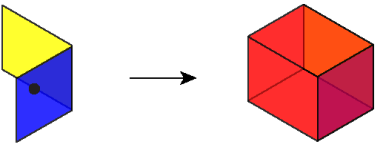

(34)

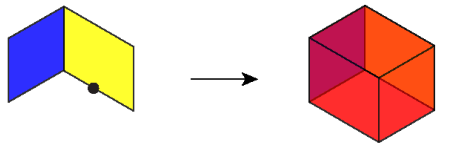

(35)

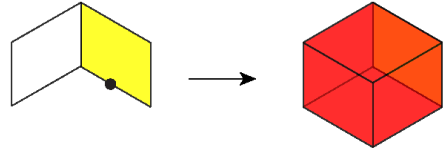

(36)

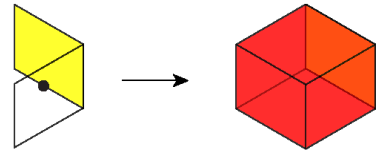

(37)

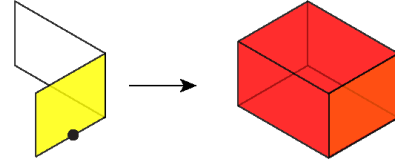

(38)

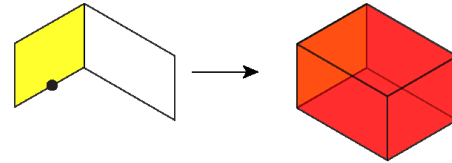

(39)

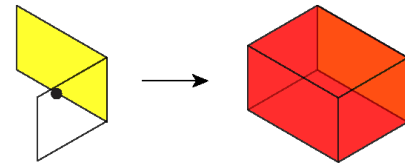

(40)

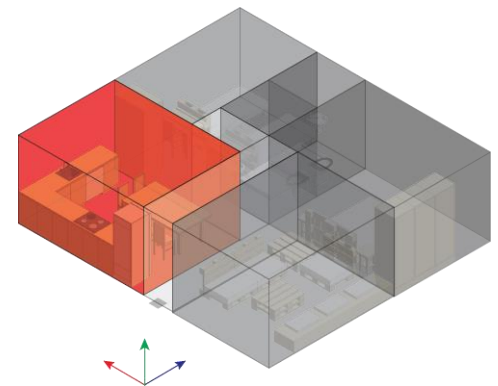
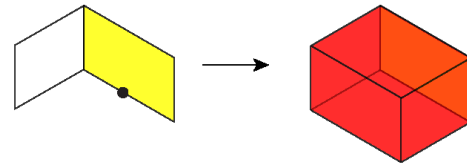

# Κανόνες Χώρων υγιεινής

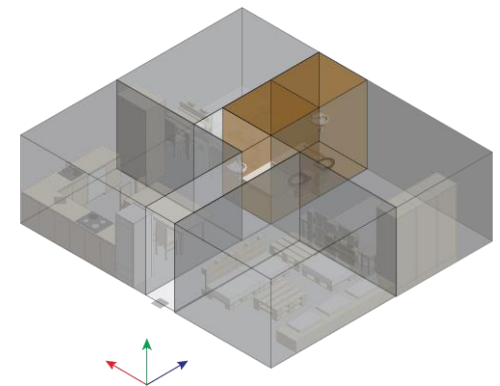
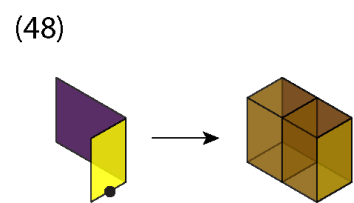
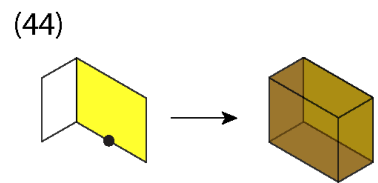
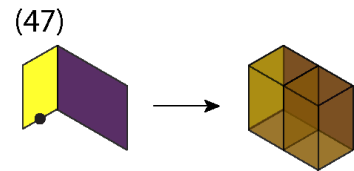
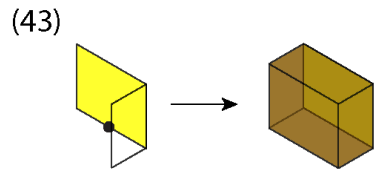
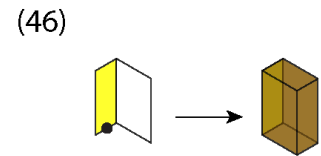
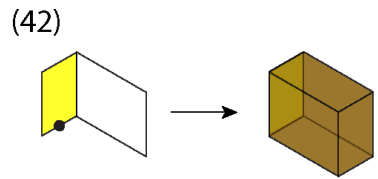
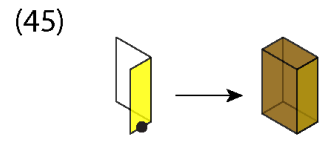
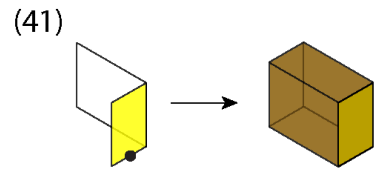

# Παιδικό υπνοδωμάτιο

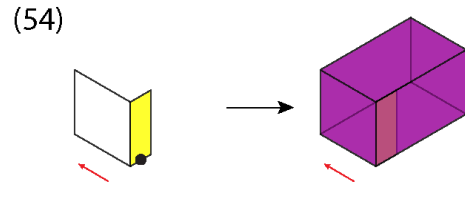
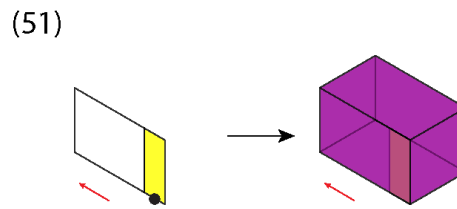
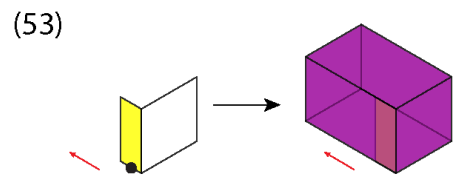
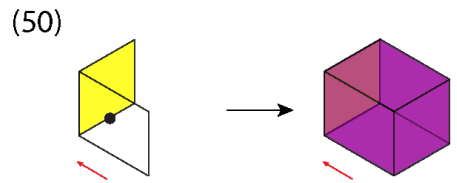
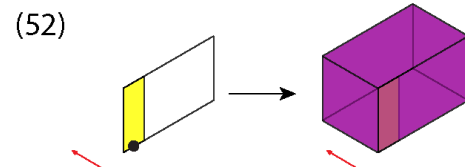
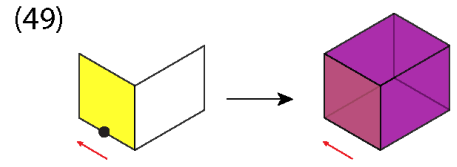

# Τερματικός Κανόνας

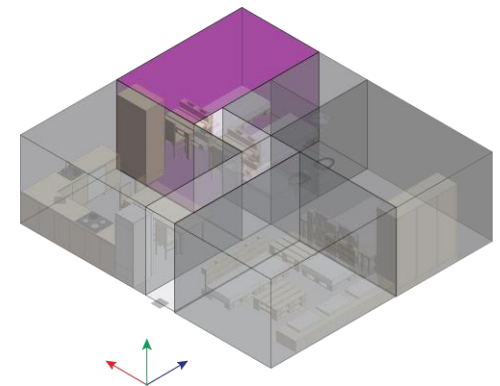



# ΣΤΑΘΕΡΟΣ ΕΞΟΠΛΙΣΜΟΣ - ΚΟΥΖΙΝΑ

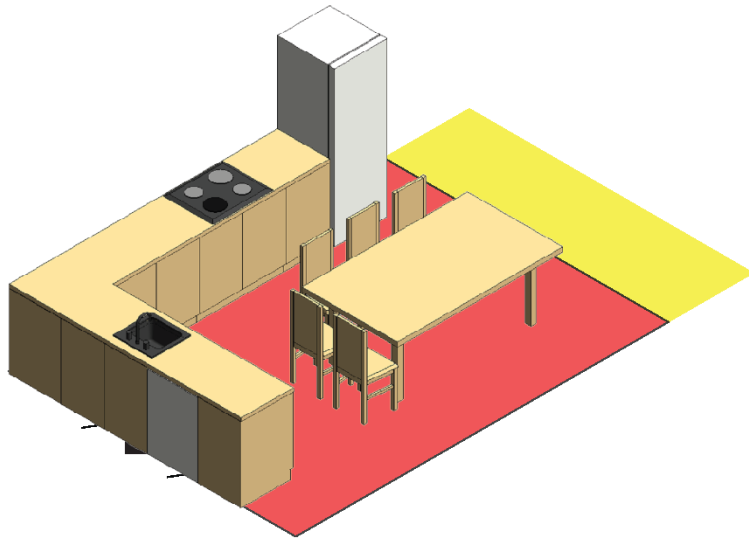
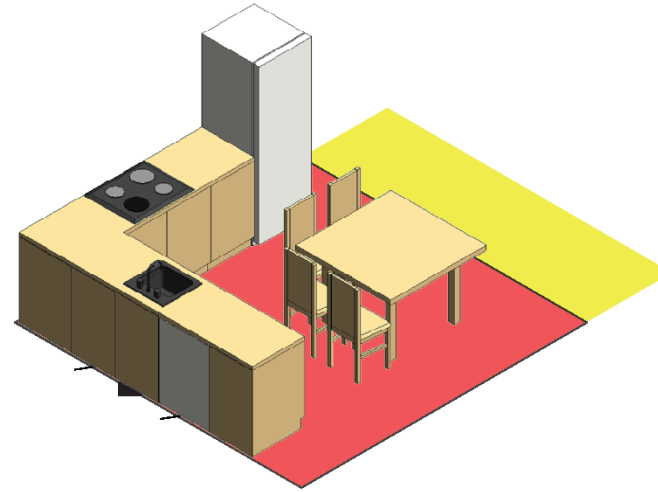
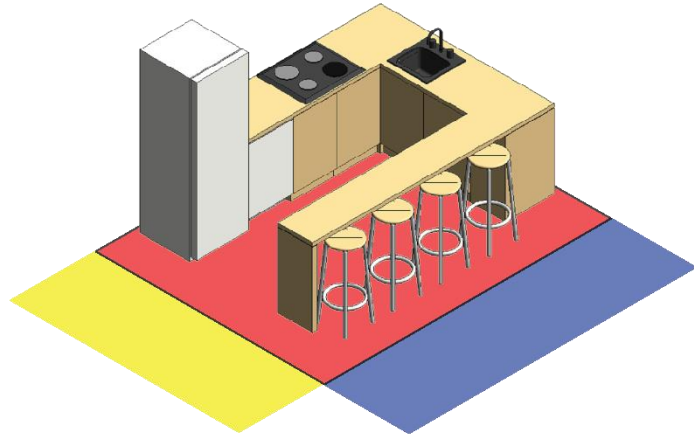

# ΣΤΑΘΕΡΟΣ ΕΞΟΠΛΙΣΜΟΣ - ΧΩΡΟΙ ΥΓΙΕΙΝΗΣ

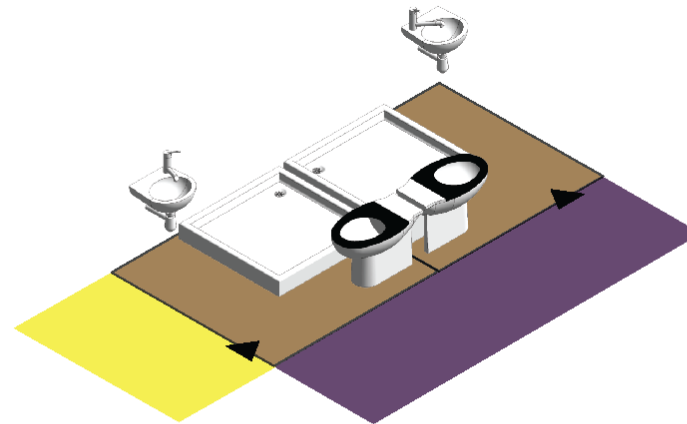
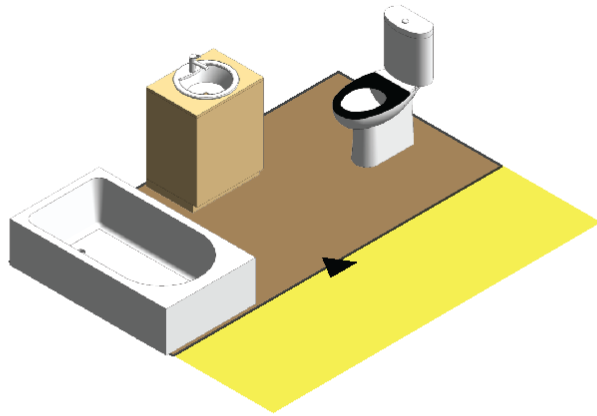
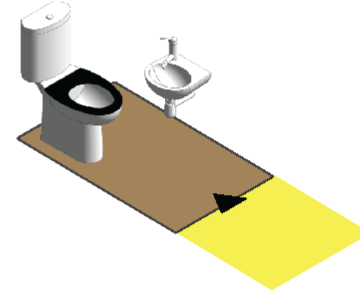
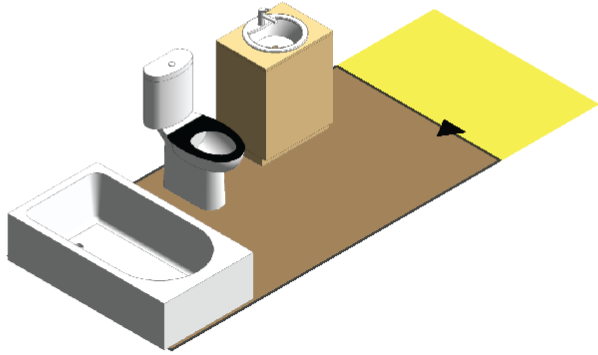

# ΜΕΤΑΒΛΗΤΟΣ ΕΞΟΠΛΙΣΜΟΣ

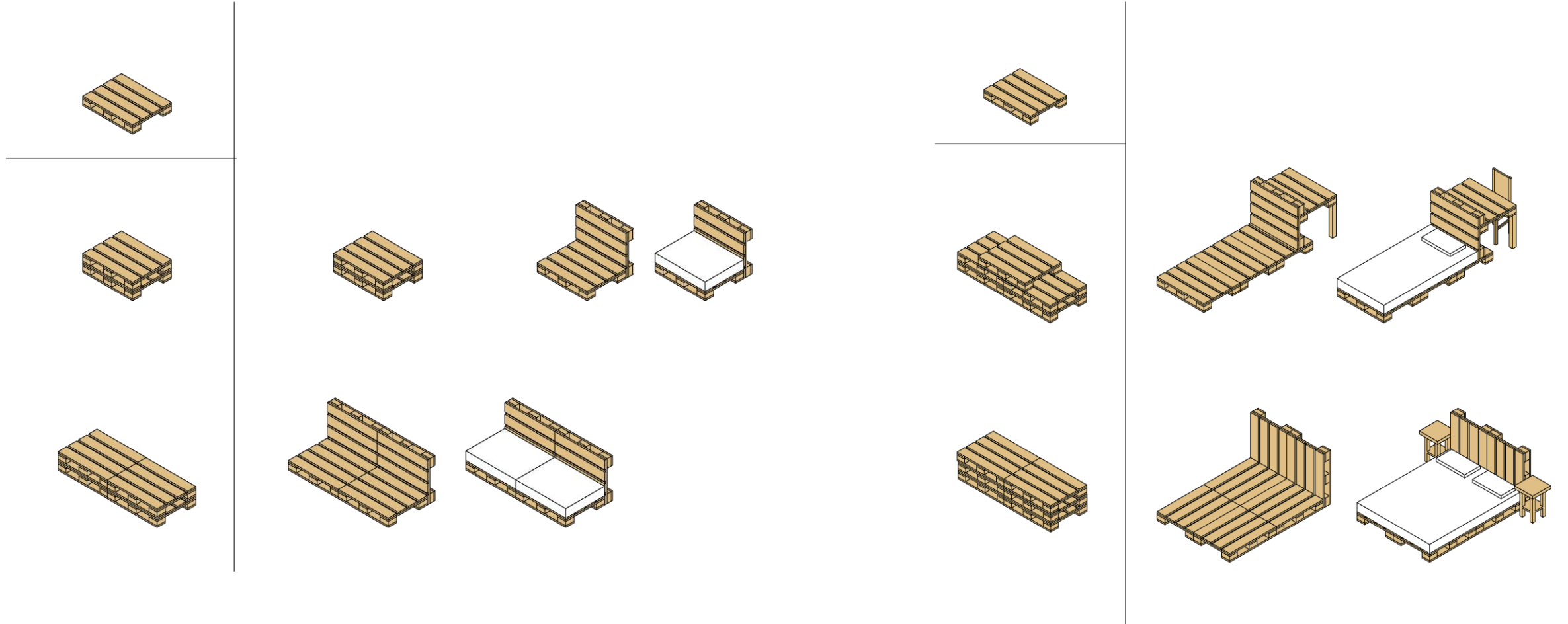



# Σήμανση Κουφωμάτων

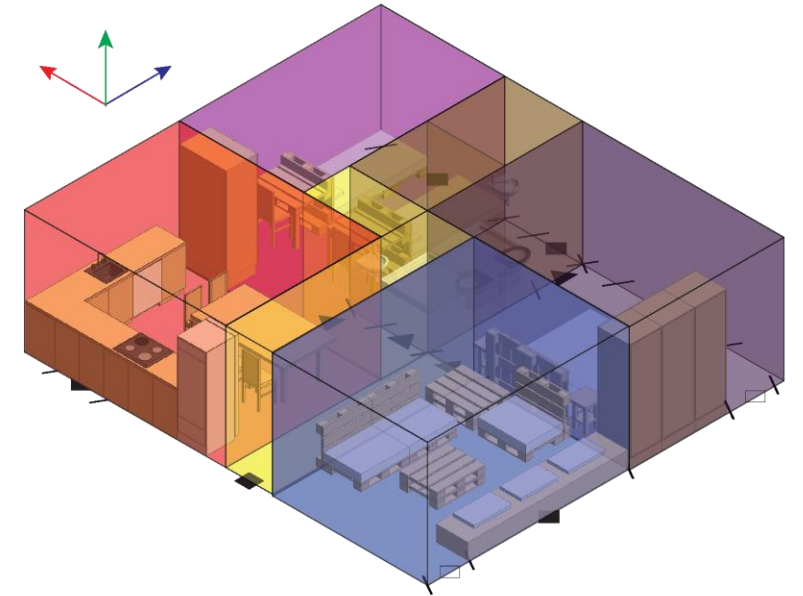
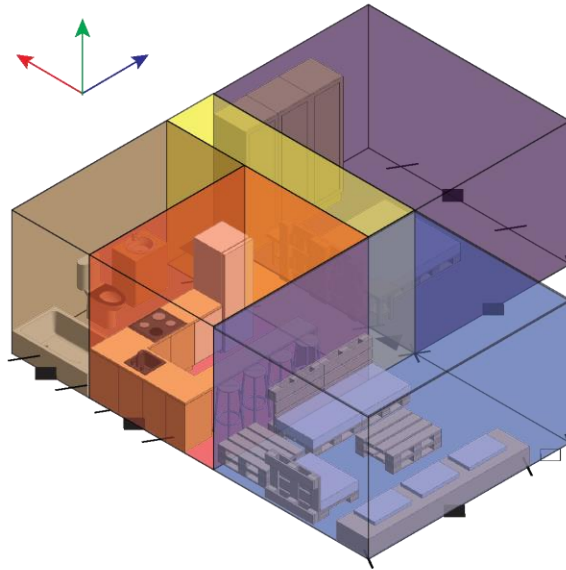
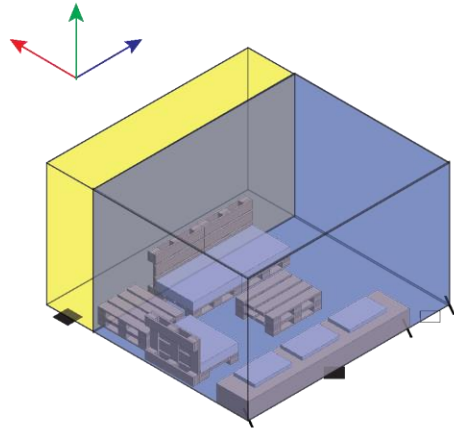

- Εξώπορτα
- ◆ Παράθυρο
- ◊ Μπαλκονόπορτα
- ▲ Εσωτερική πόρτα

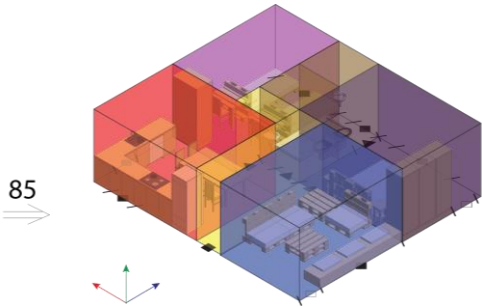
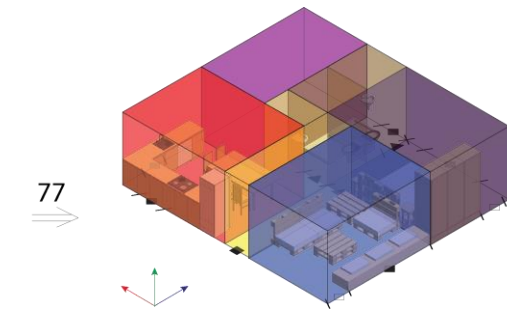
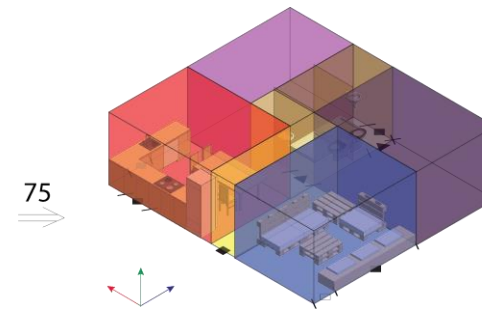
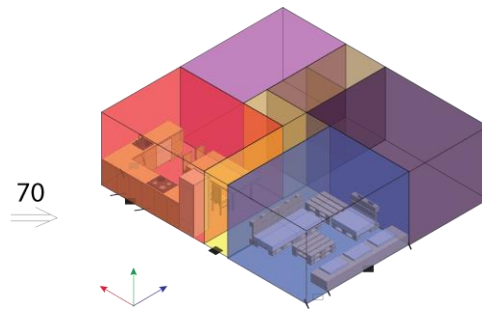
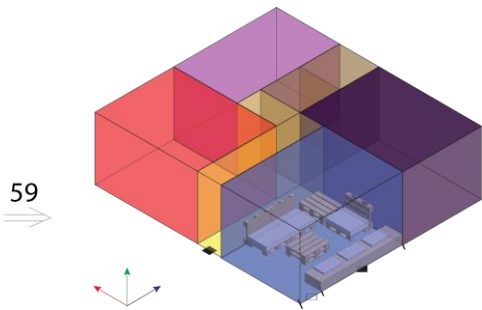
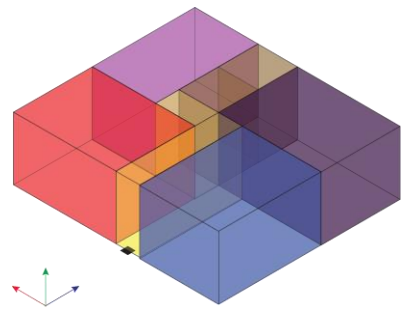
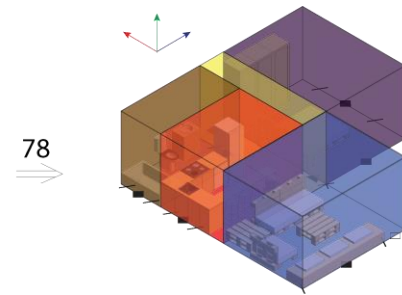
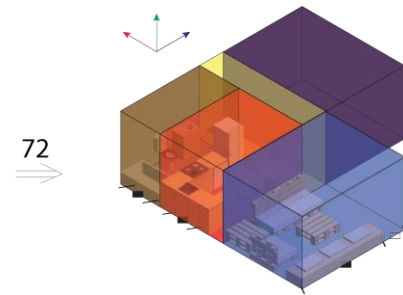
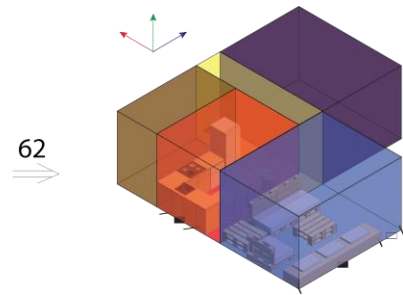
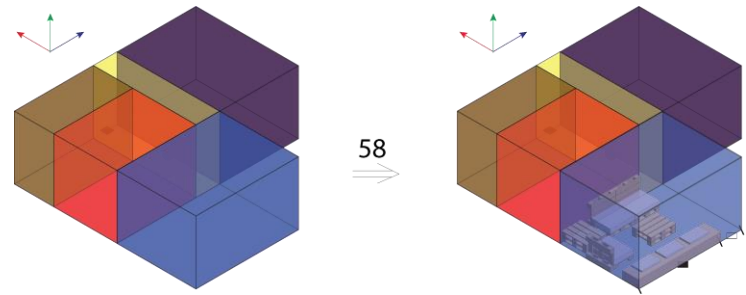
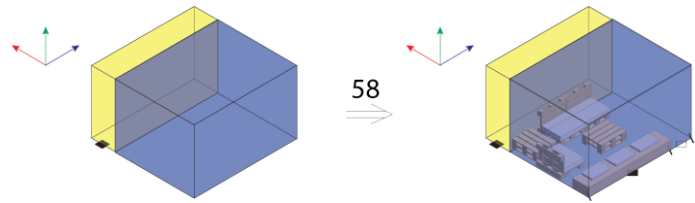

# Κανόνες Καθιστικού

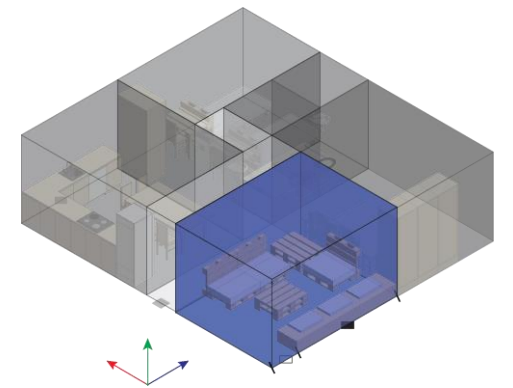
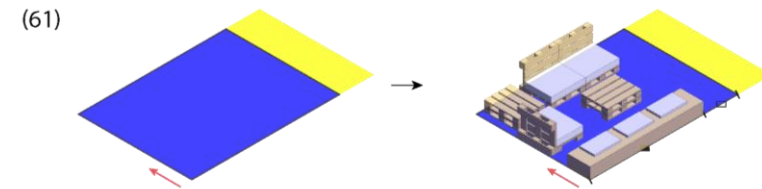
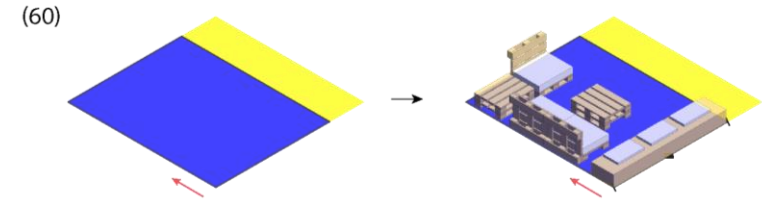
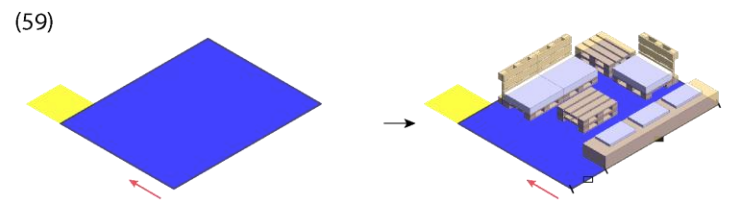
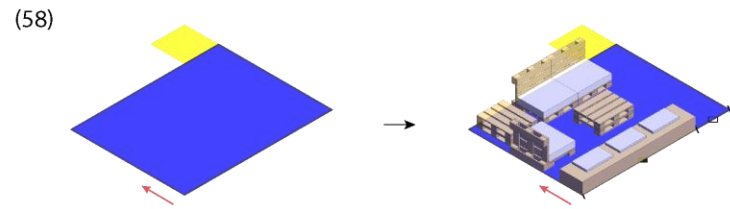
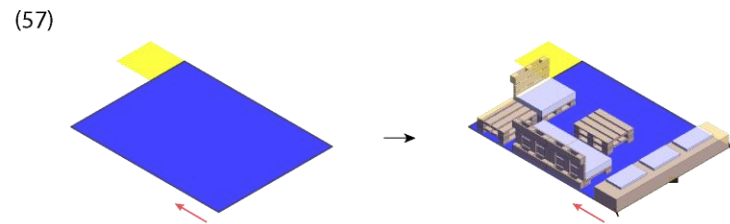
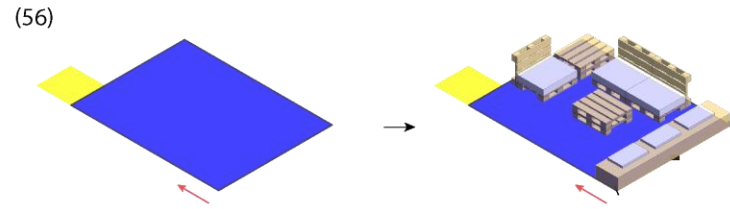

# Κανόνες Κουζίνας

(62)

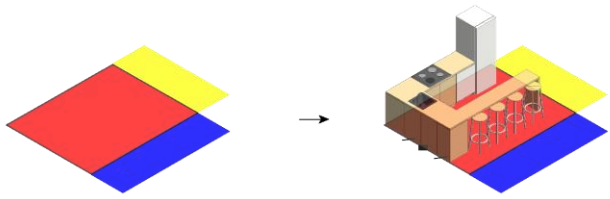

(63)

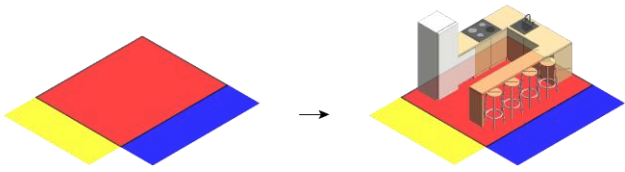

(64)

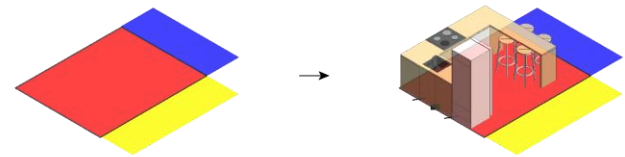

(65)

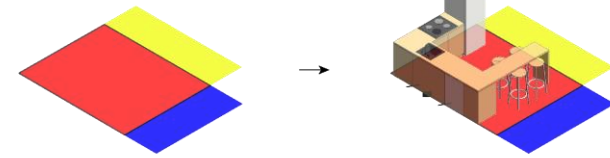

(68)

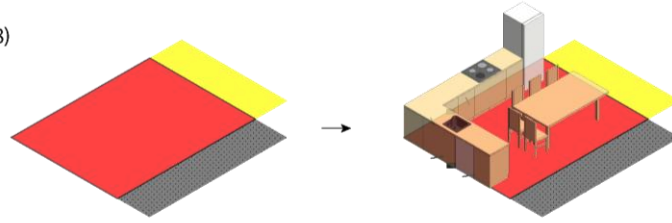

(69)

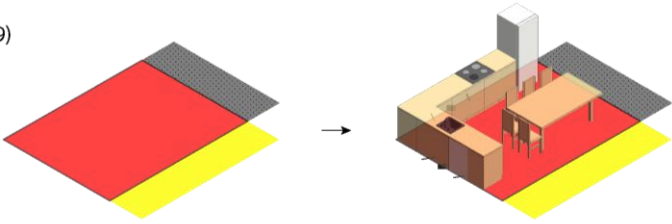

(70)

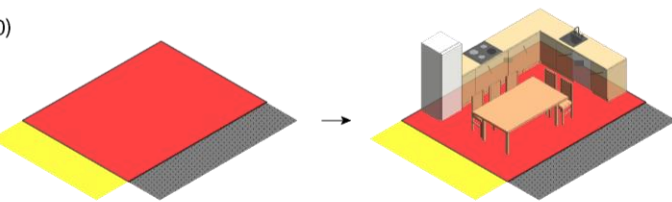

(71)

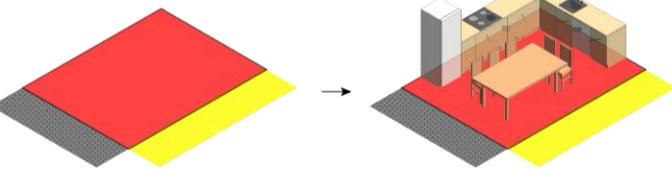

(66)

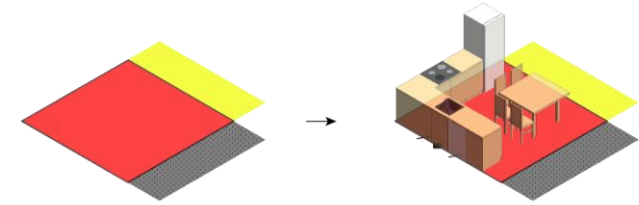

(67)

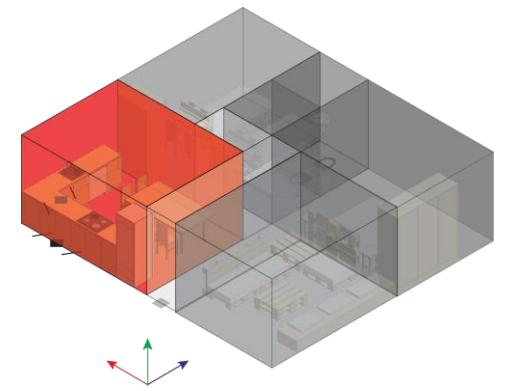
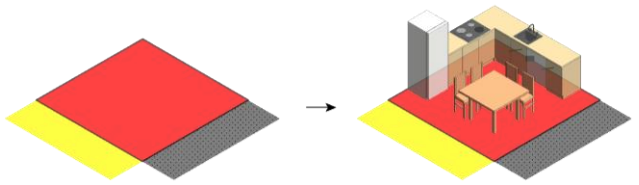

# Κανόνες Χωρών Υγιεινής

(72)

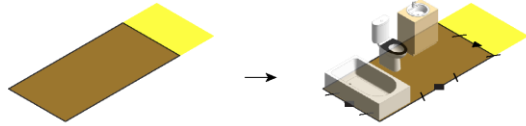

(73)

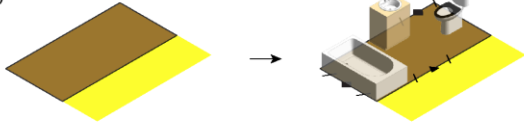

(74)

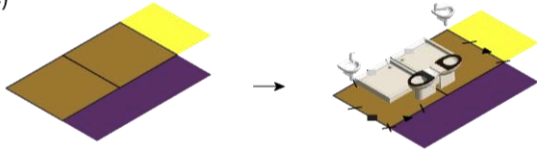

(75)

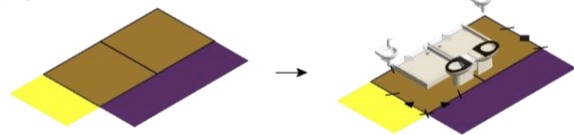

(76)

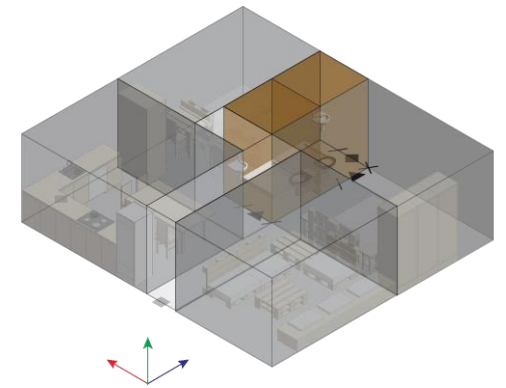

# Κανόνες Κυρίως Υπνοδωματίου

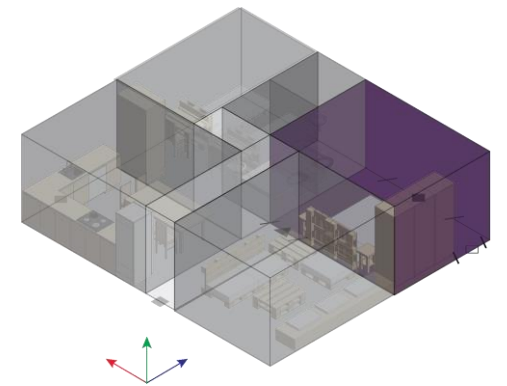
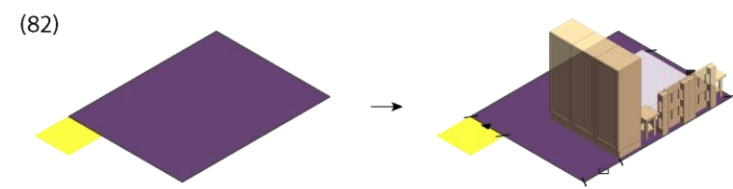
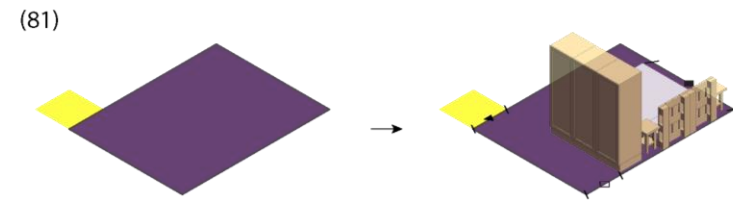
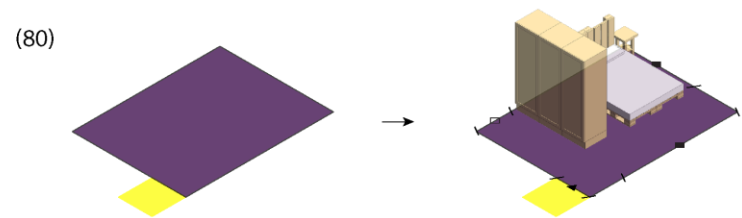
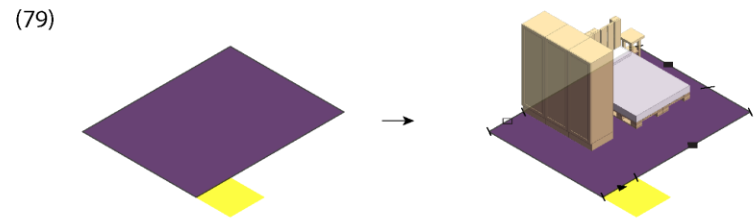
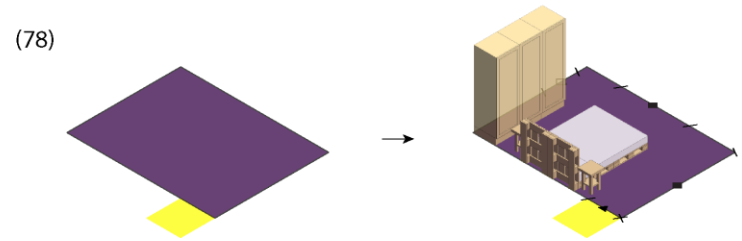
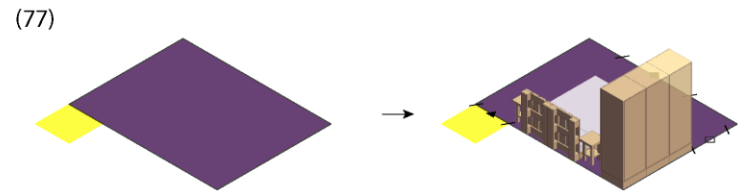

# Κανόνες Παιδικού Υπνοδωματίου

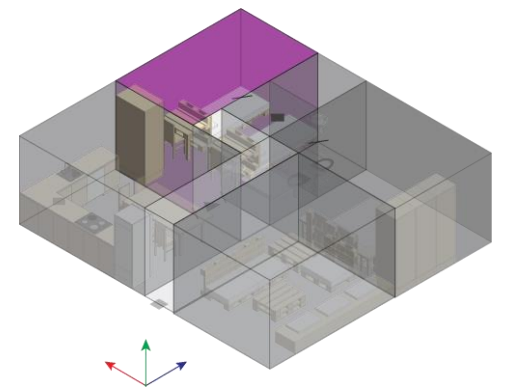
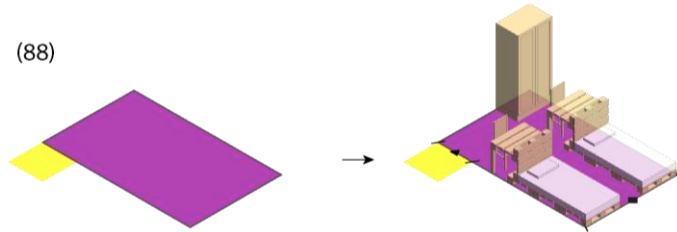
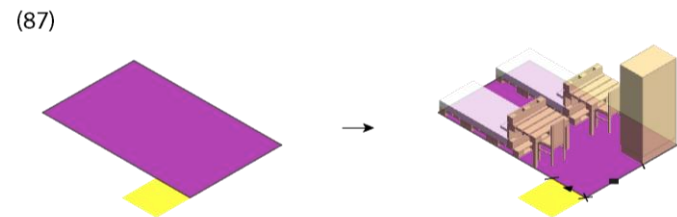
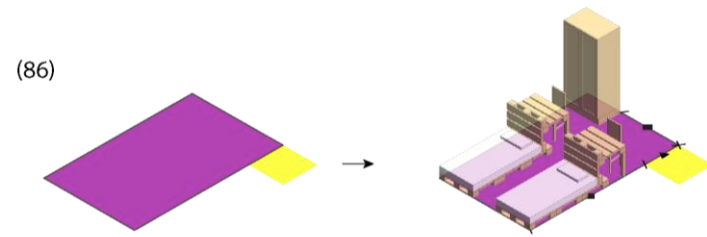
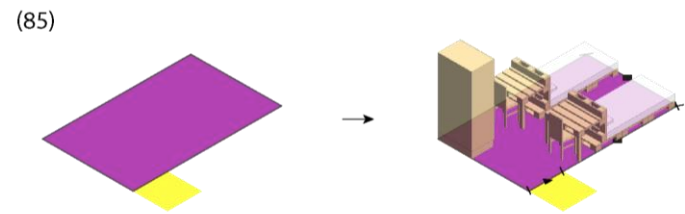
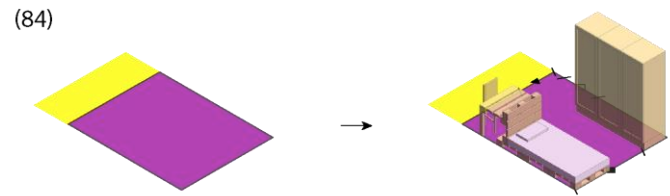
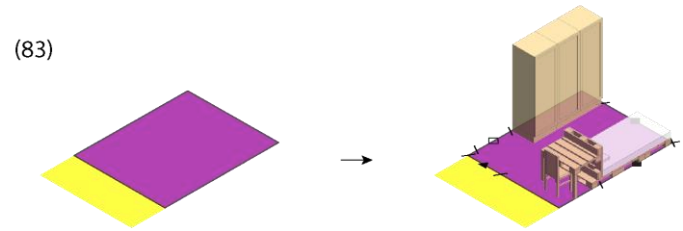

## 7. Οικοδομική Καταλυμάτων Επανένταξης





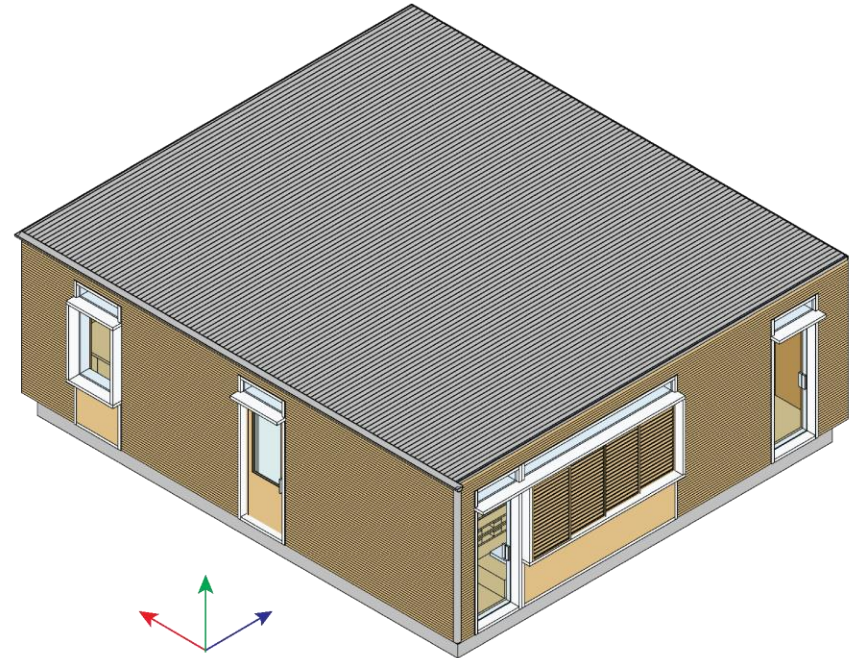
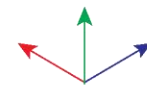
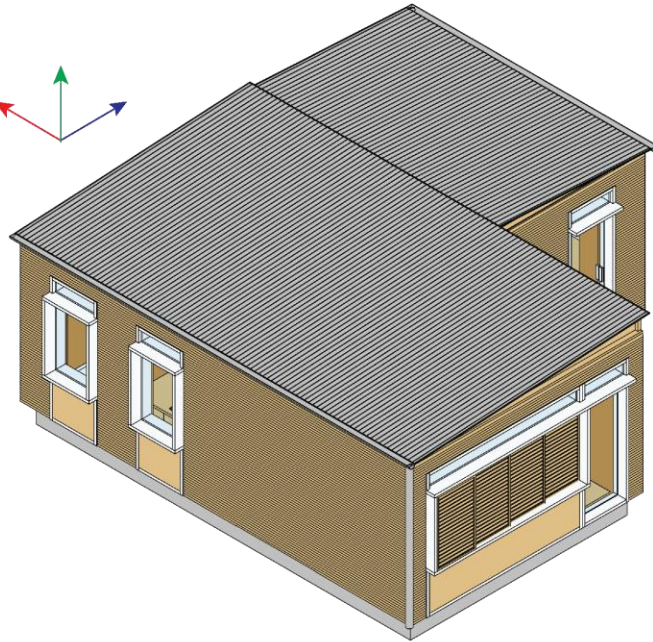
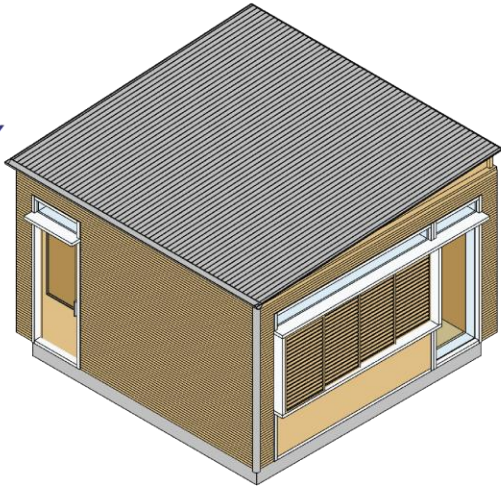
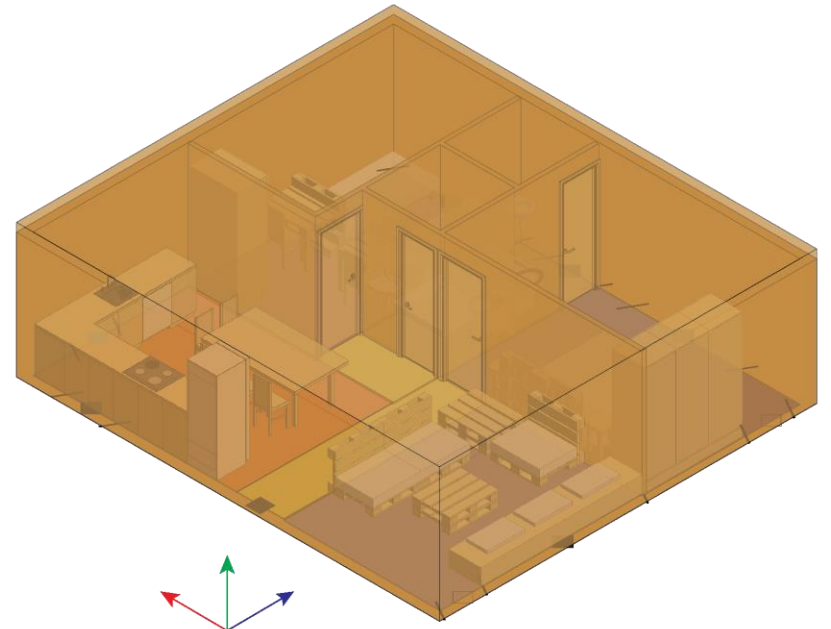
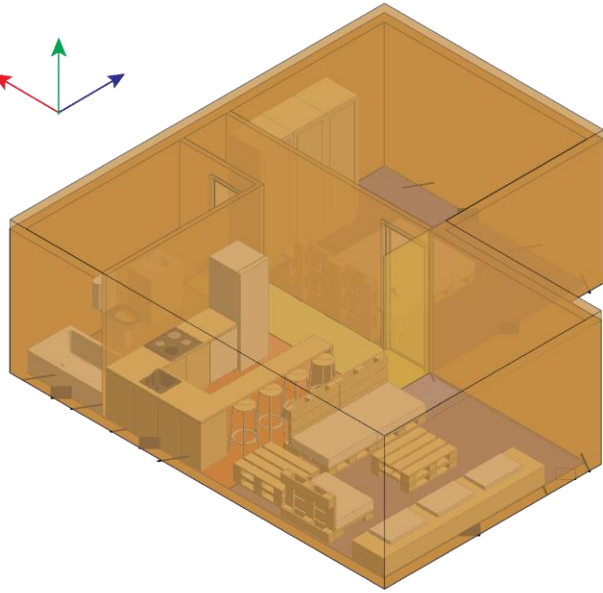
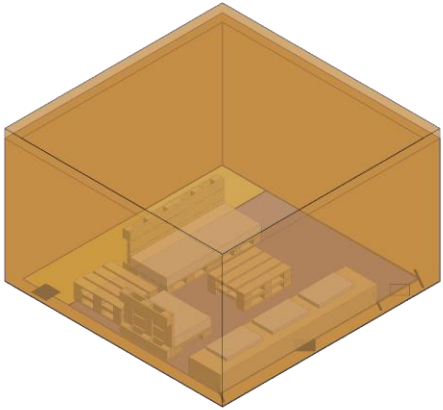
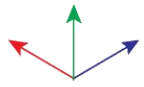

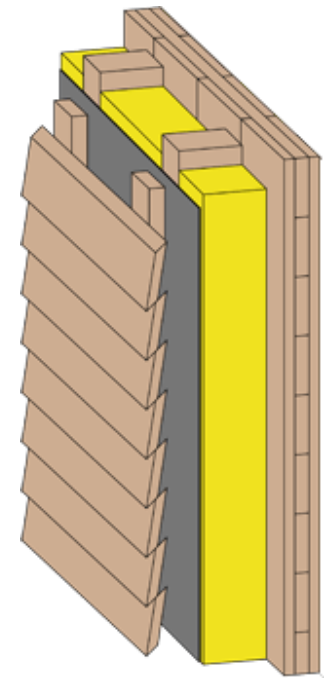
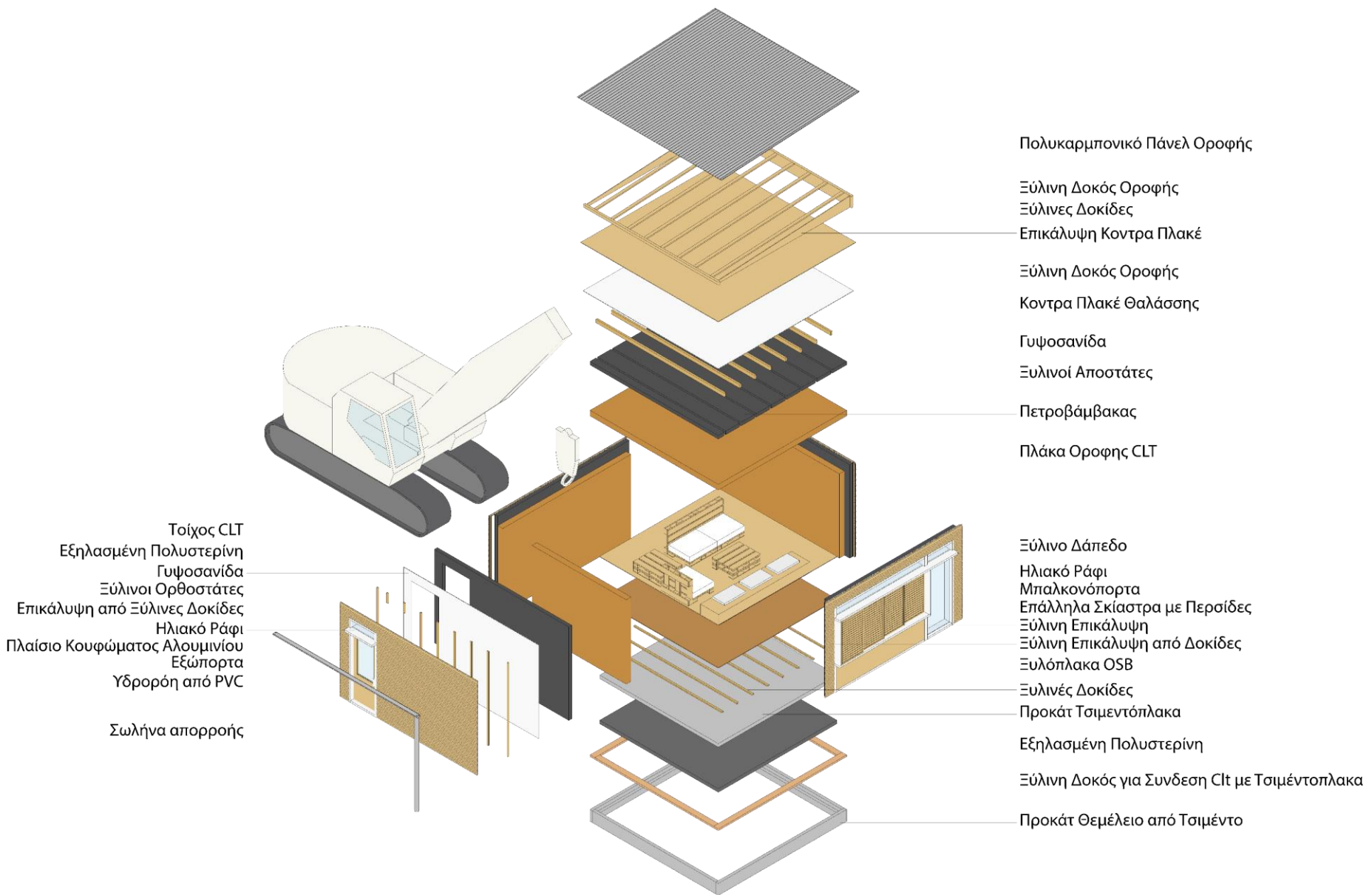

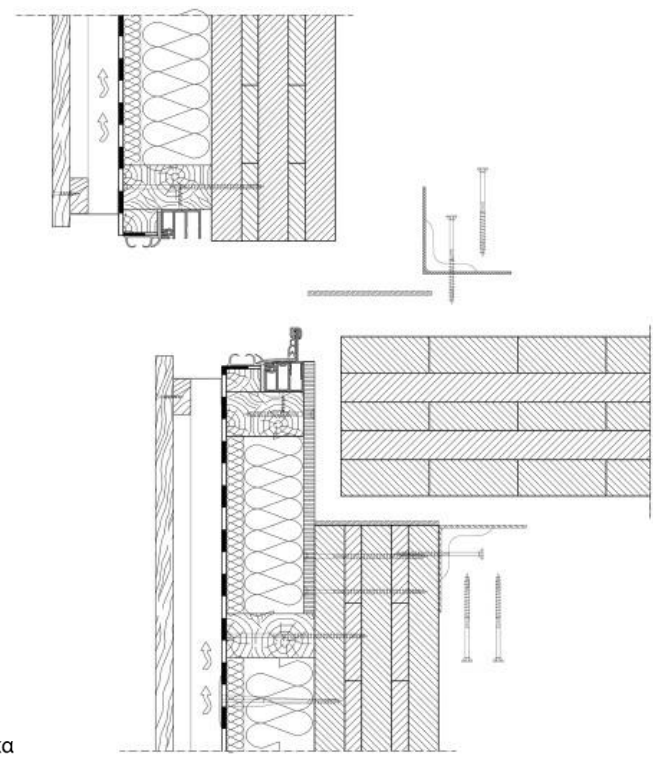
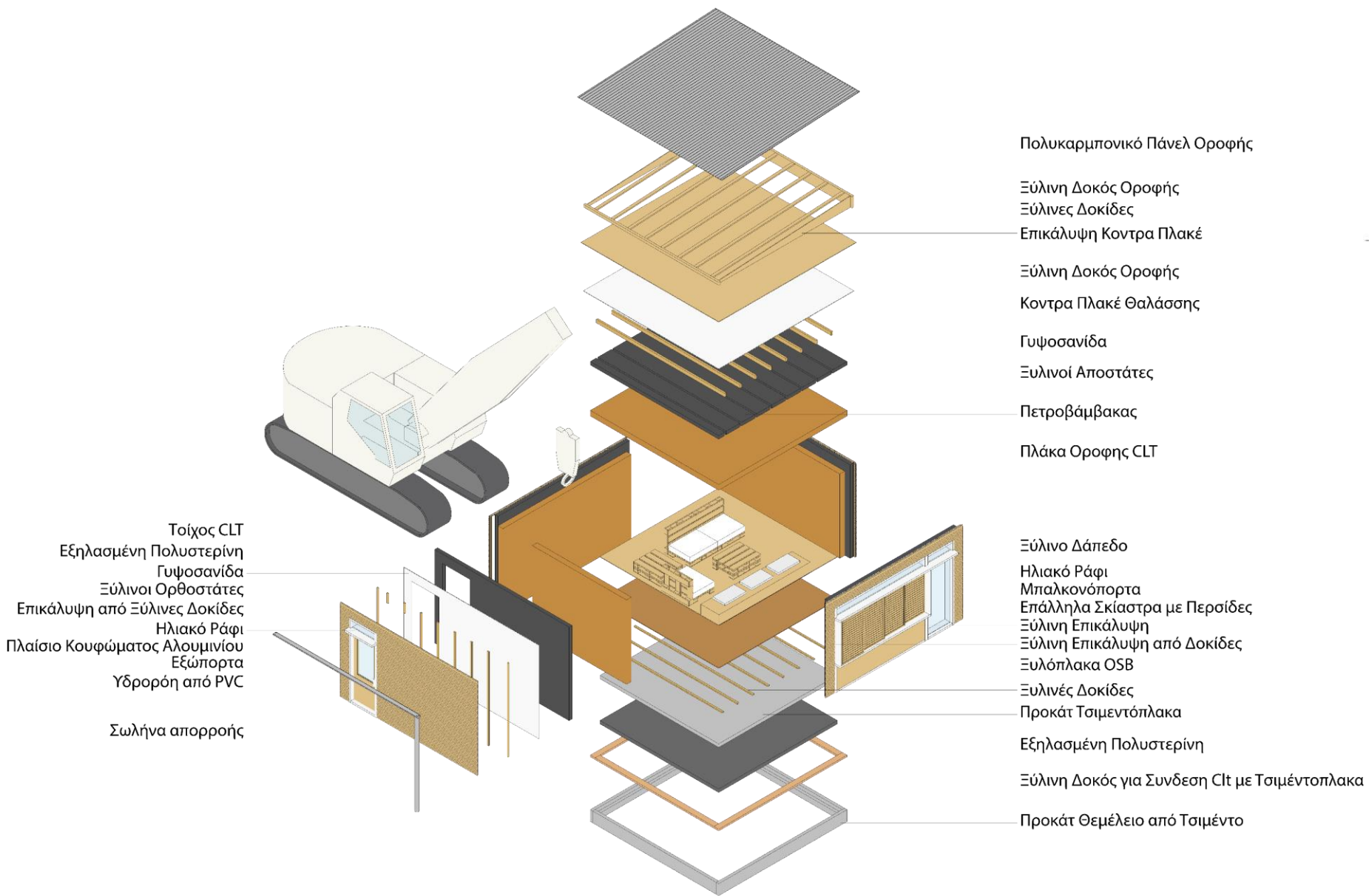

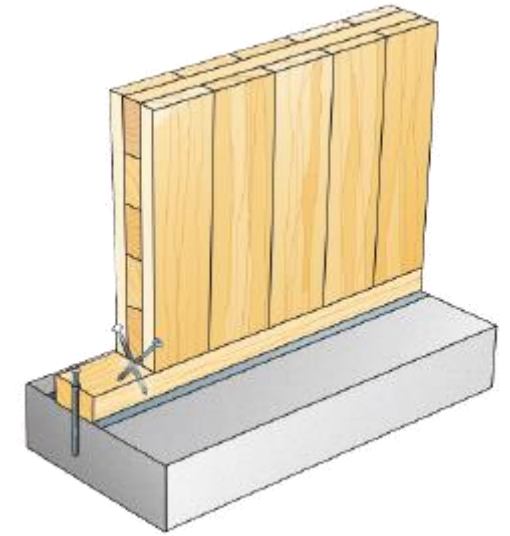
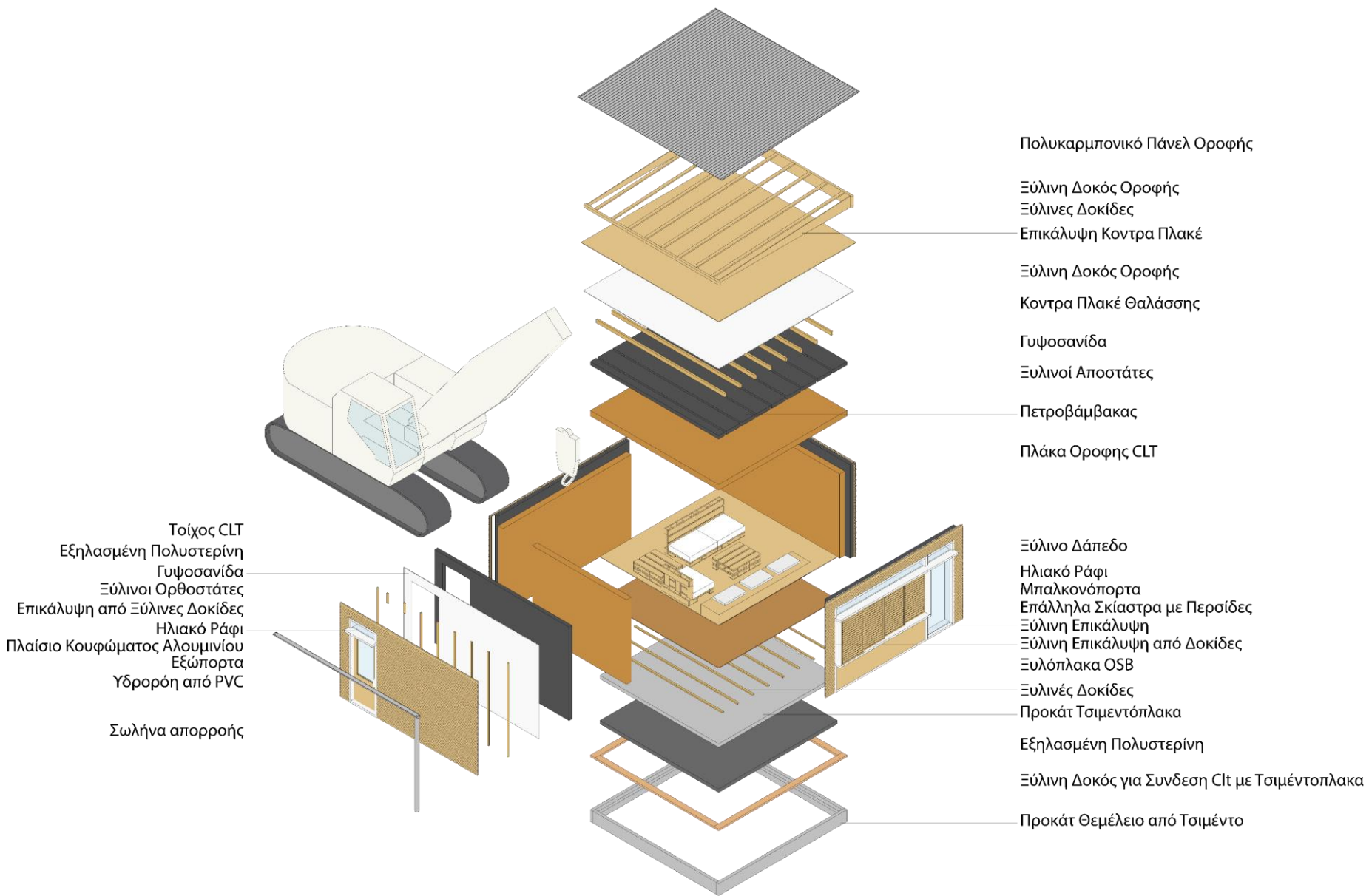

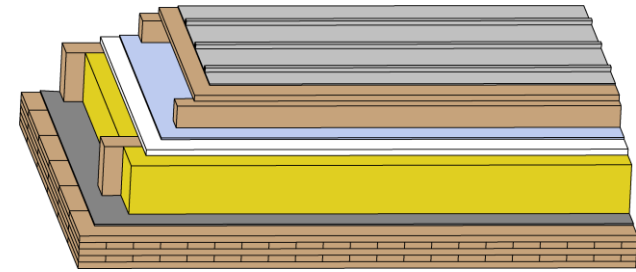
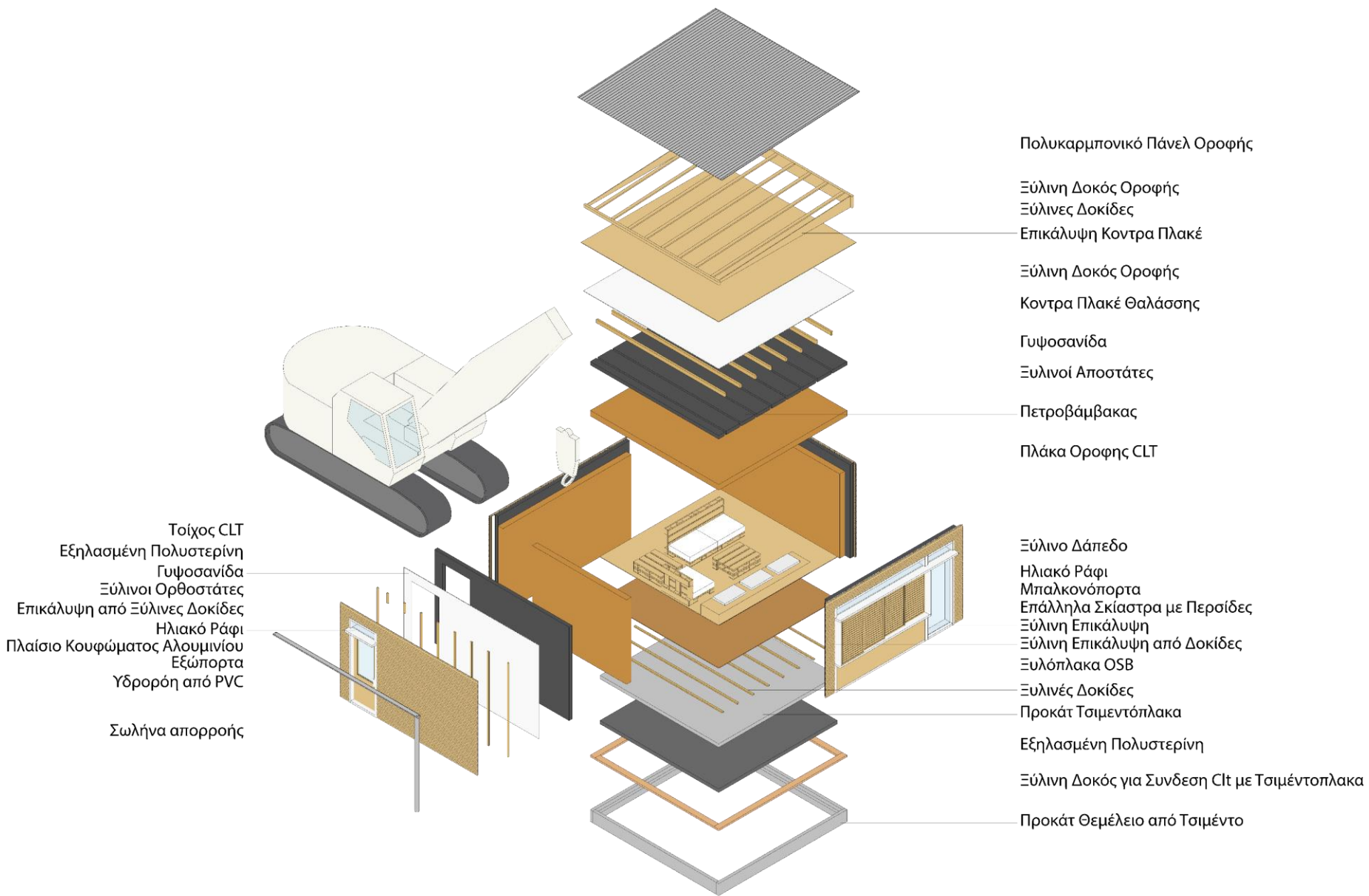



# Παράδειγμα 1

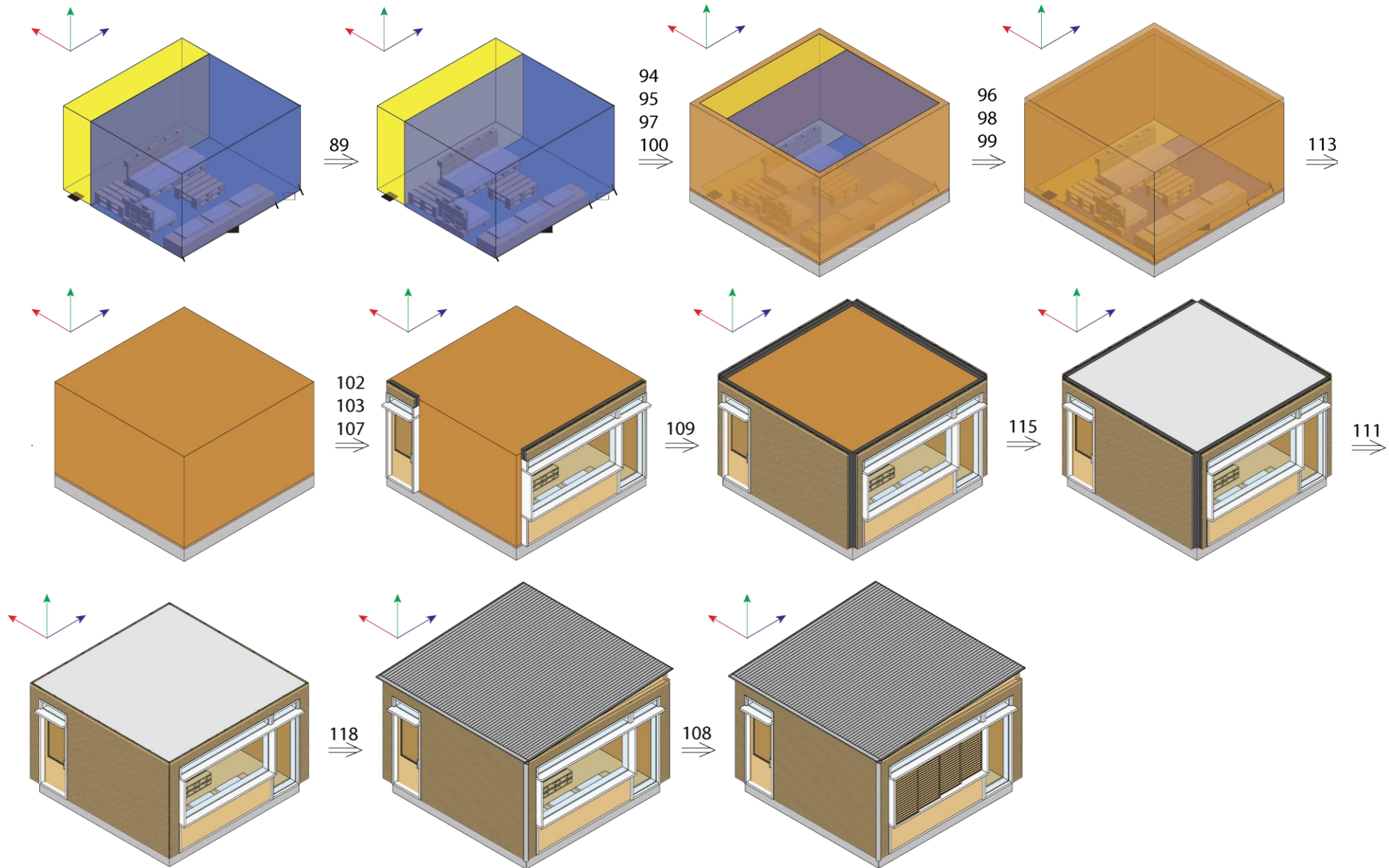



# Παράδειγμα 2

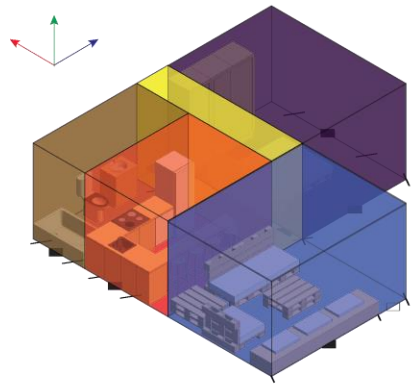

89  
90  
91  
93  
⇒

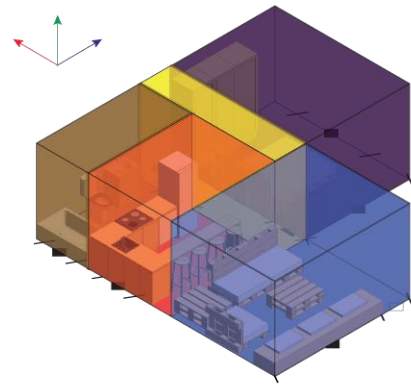

104  
⇒

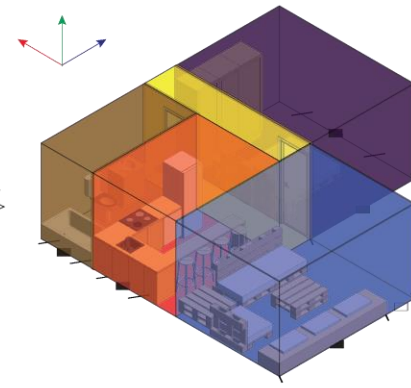

94  
95  
97  
100  
⇒

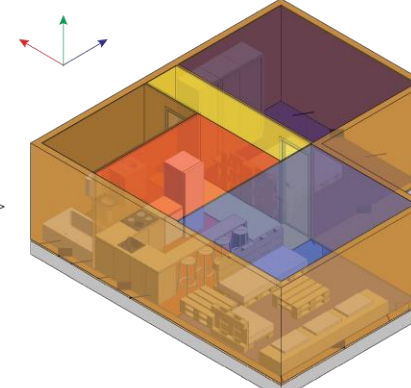

96  
98  
99  
⇒

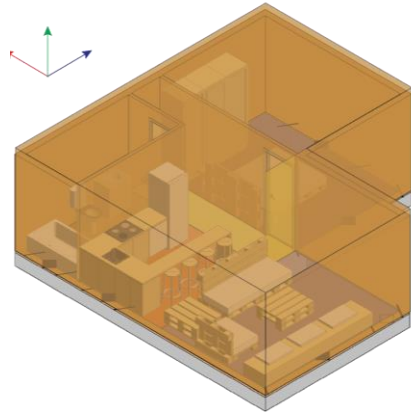

113  
⇒

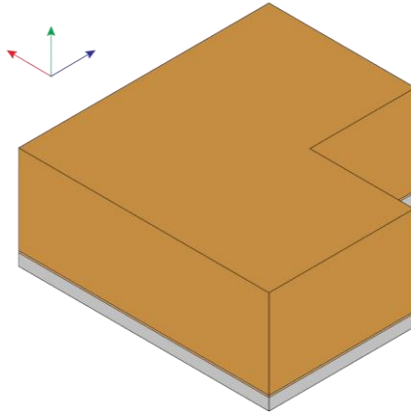

102  
103  
104  
106  
107  
⇒

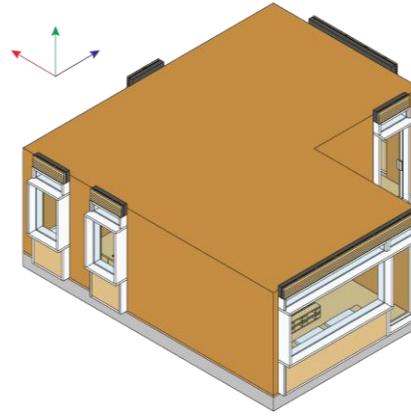

109  
⇒

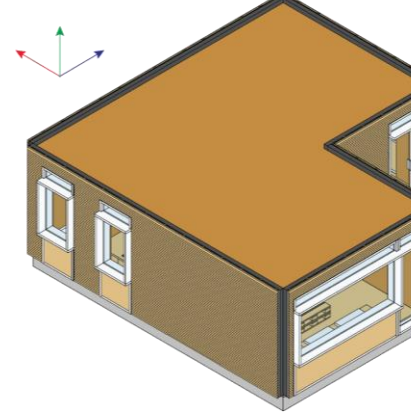

115  
⇒

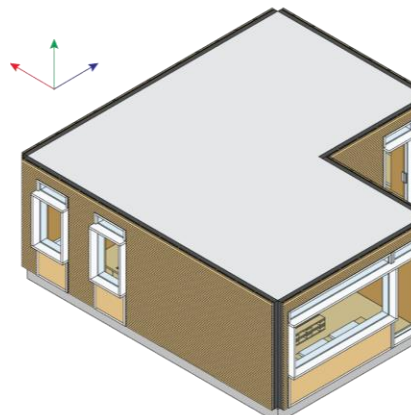

111  
⇒

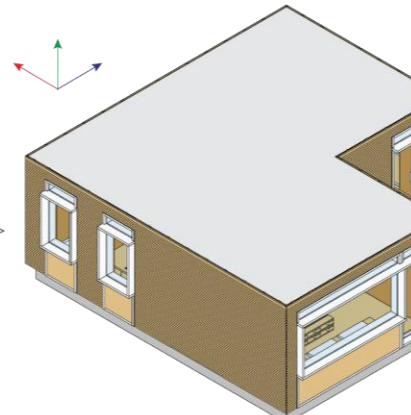

118  
⇒

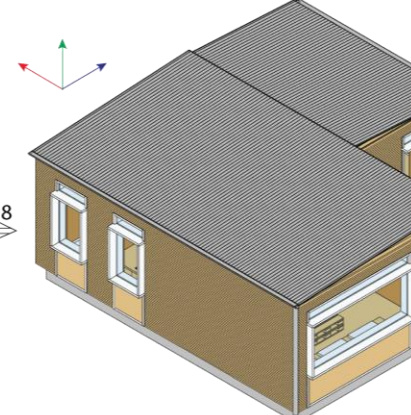

108  
⇒

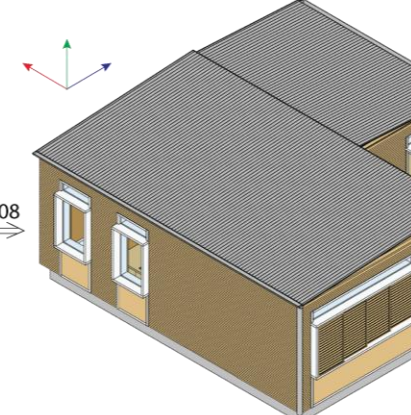

# Παράδειγμα 3

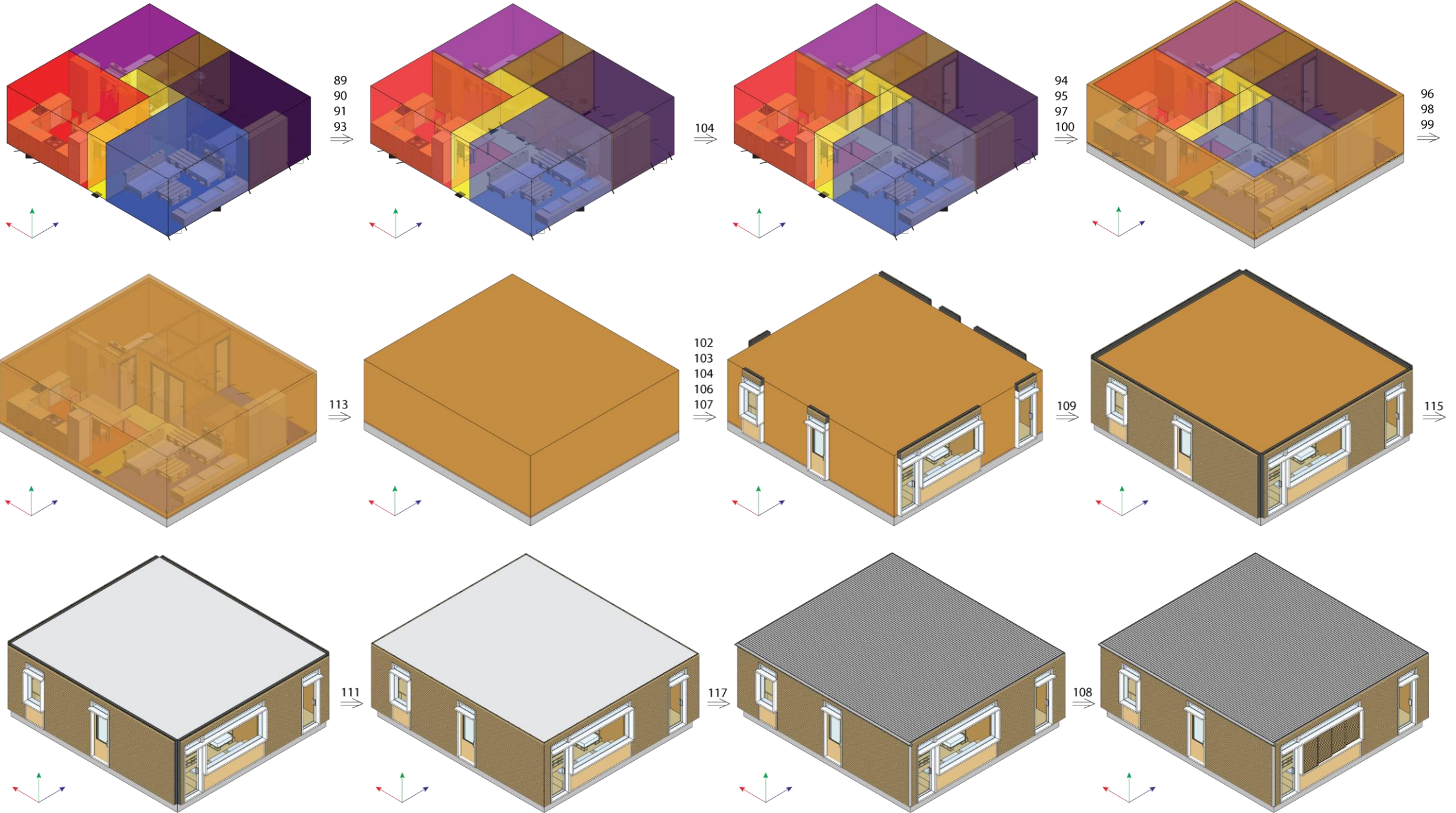

# Τοποθέτηση Τοίχων

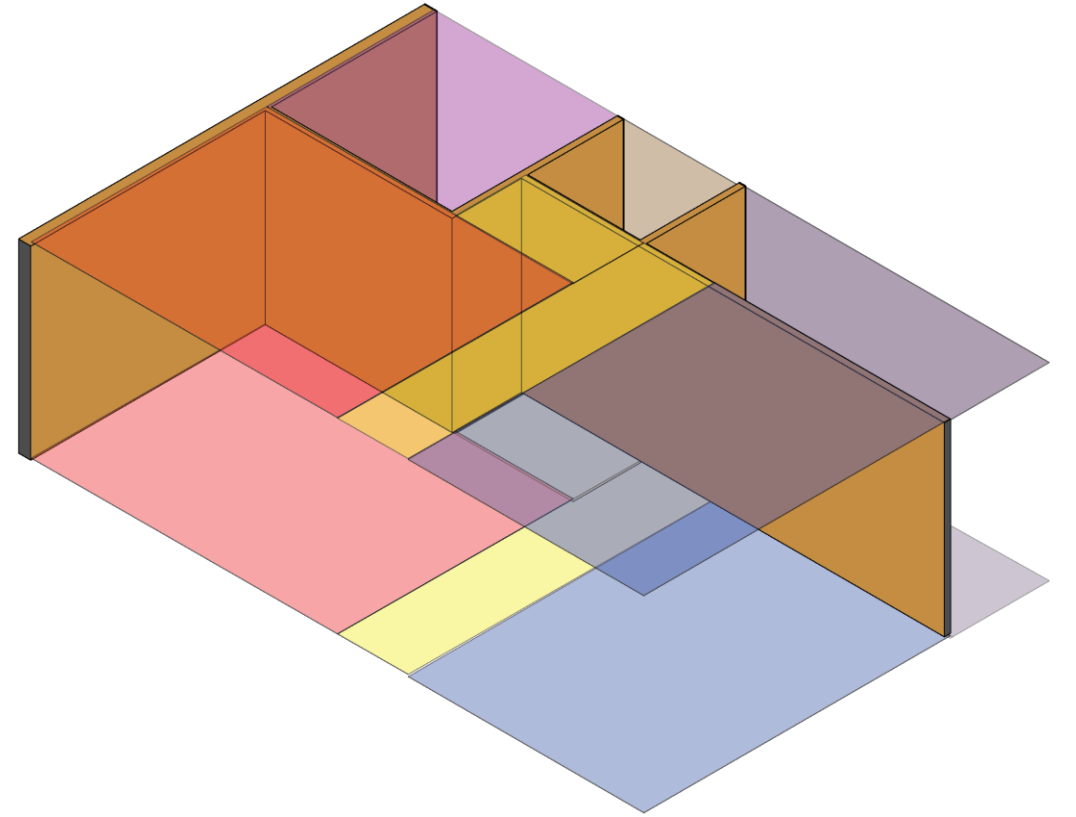
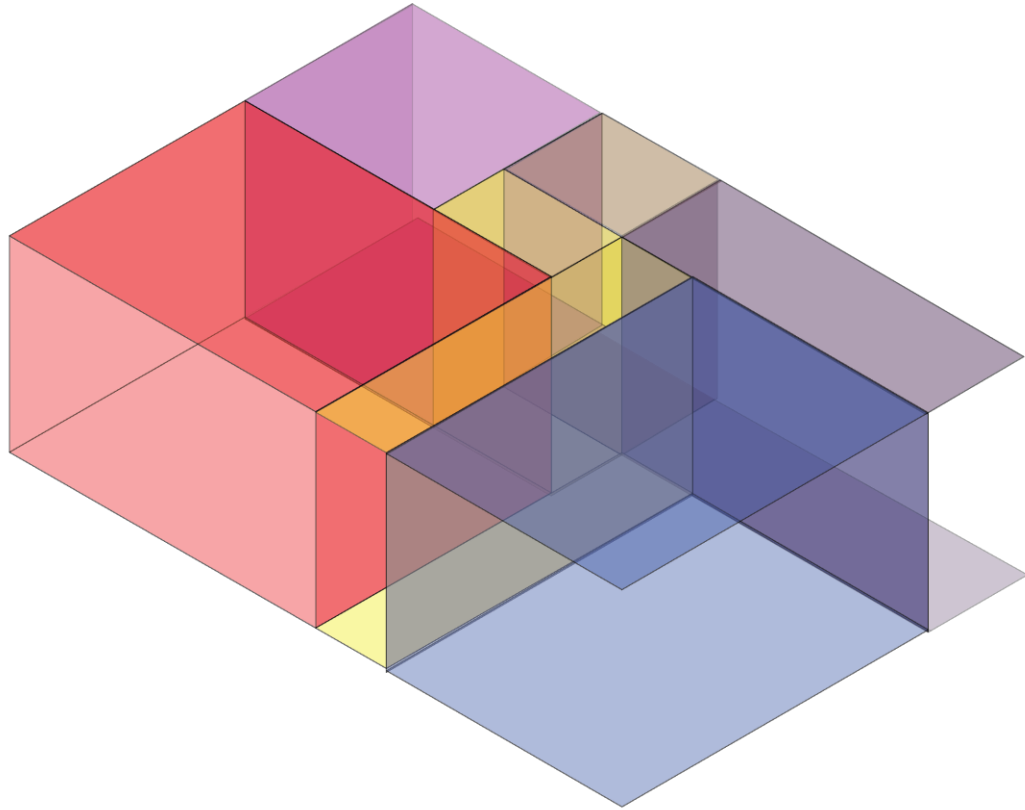

# Κατασκευαστικοί Κανόνες

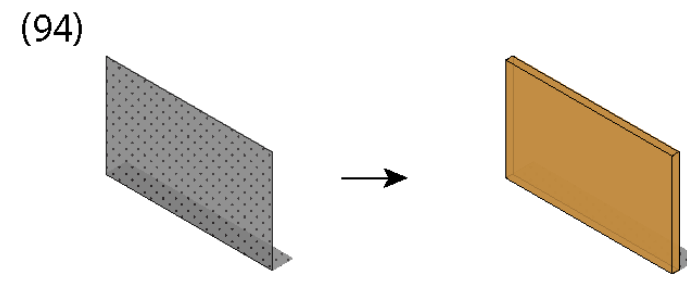
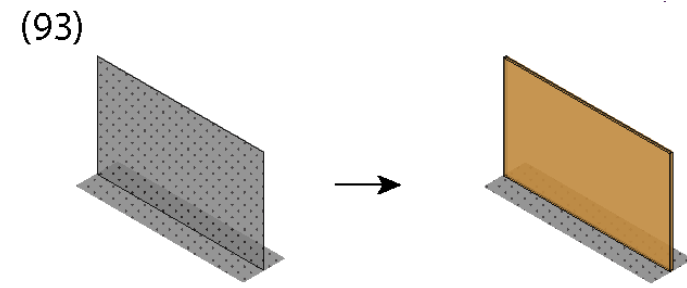
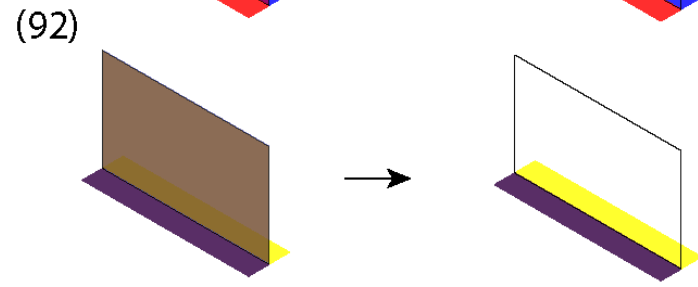
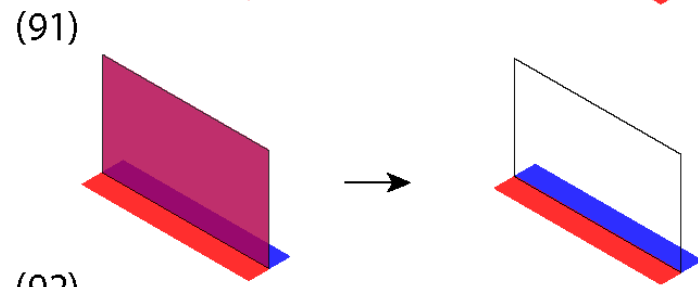
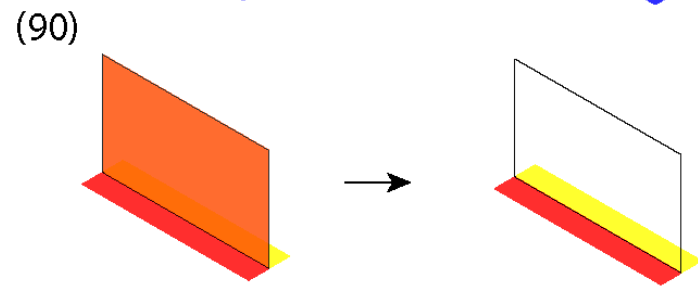
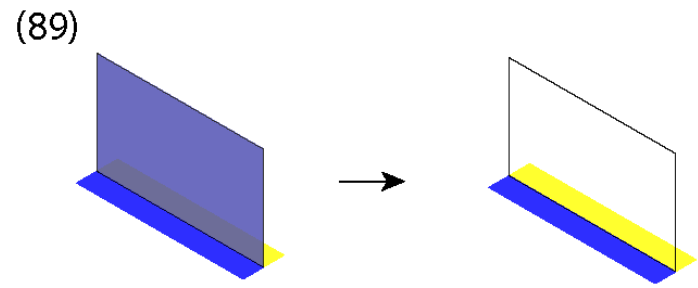

# Τοποθέτηση Πλακών

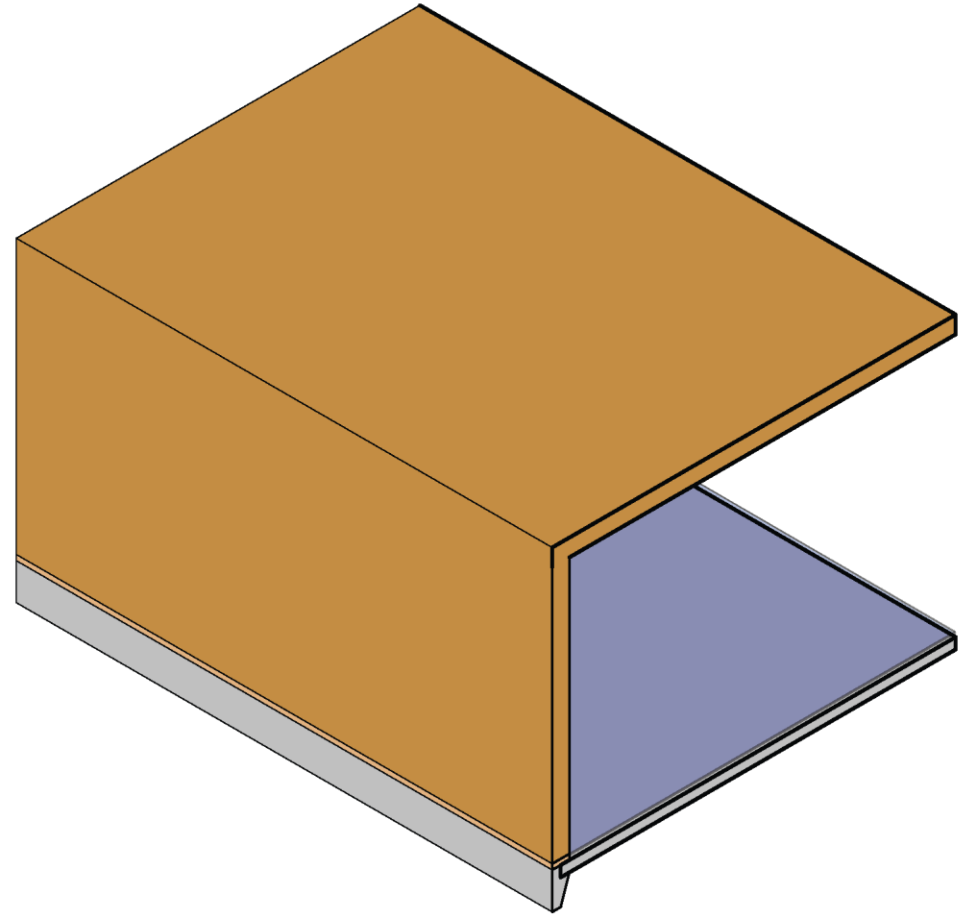
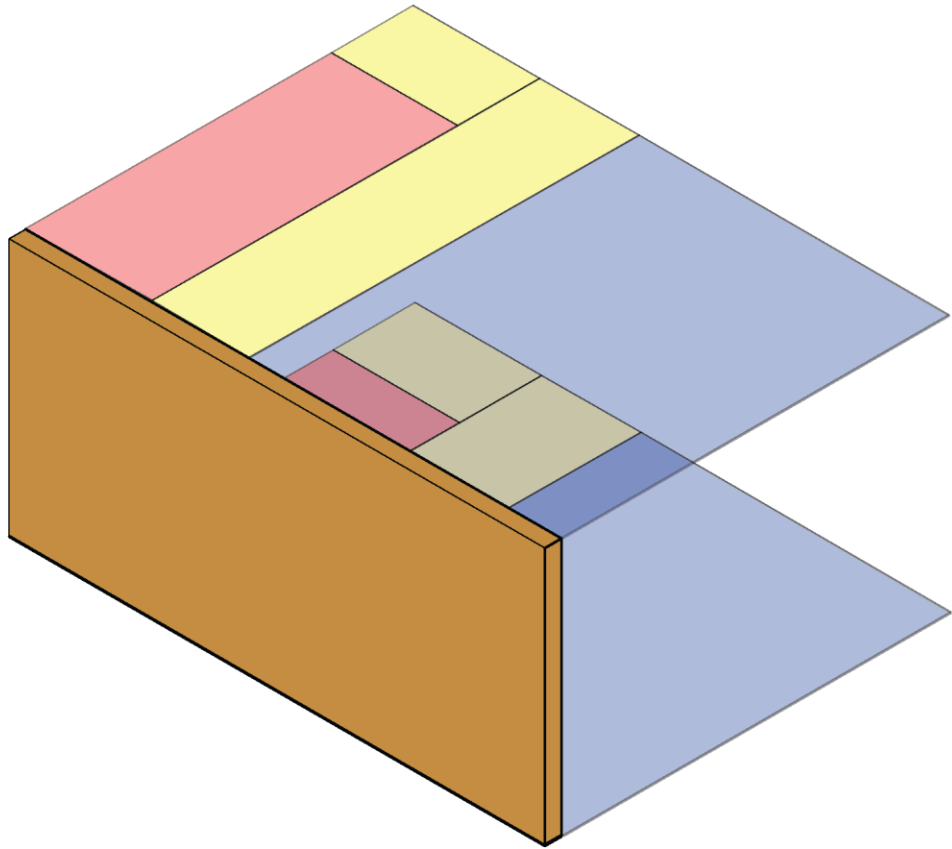

# Κατασκευαστικοί Κανόνες

(96)

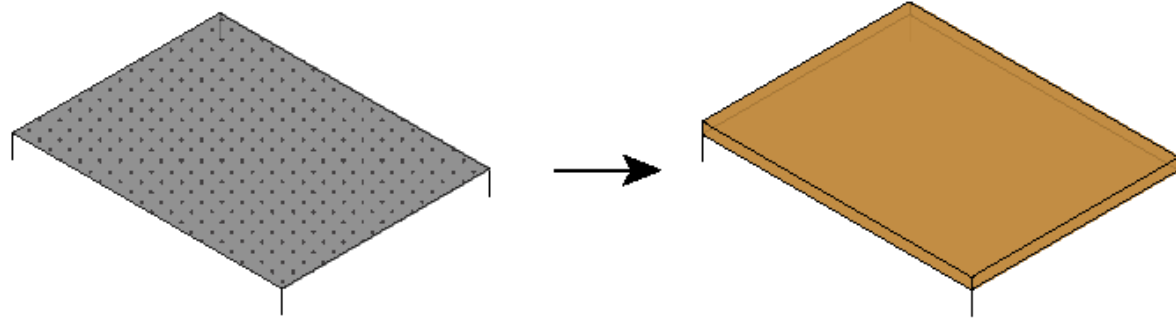

(97)

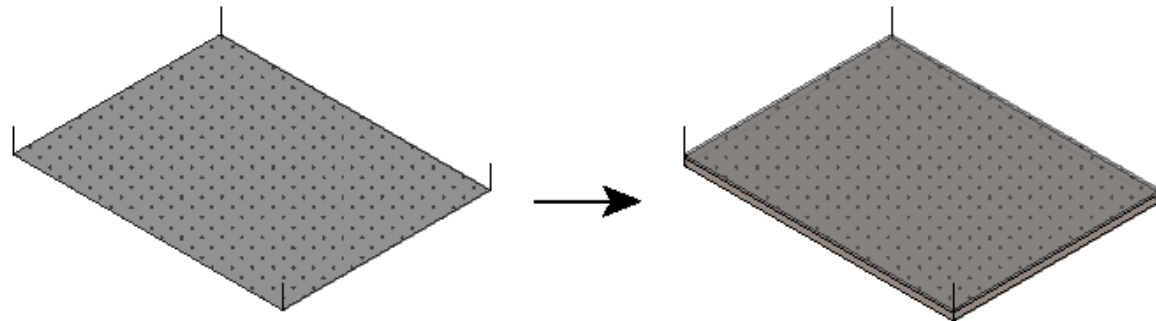

(100)

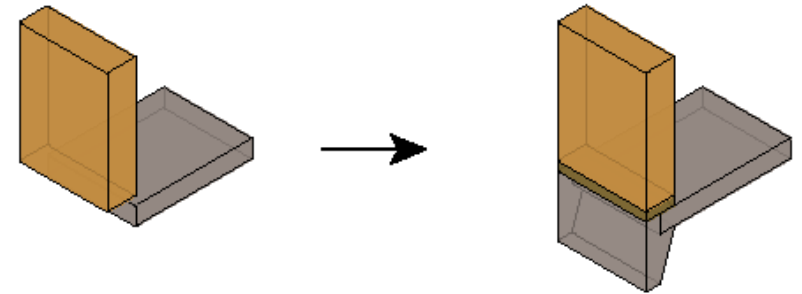

# Τοποθέτηση Κουφωμάτων

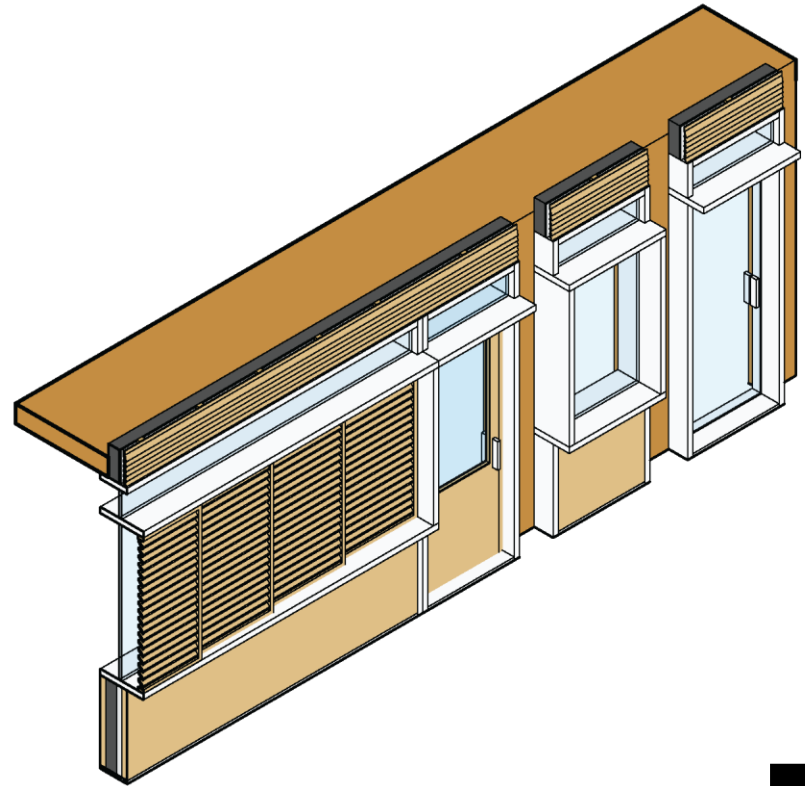
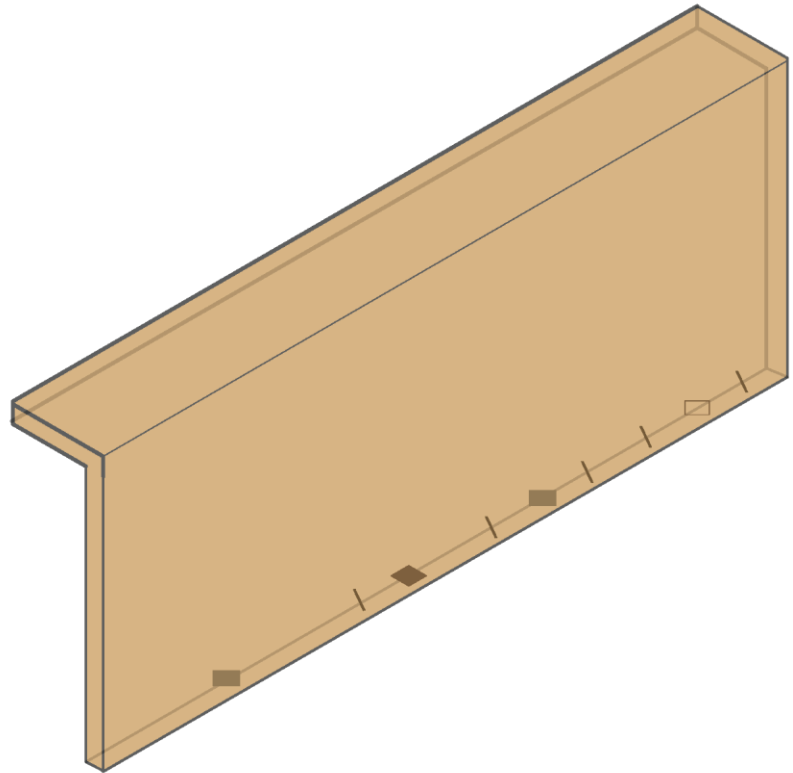

- Εξώπορτα
- ◆ Παράθυρο
- ◊ Μπαλκονόπορτα
- ▲ Εσωτερική πόρτα

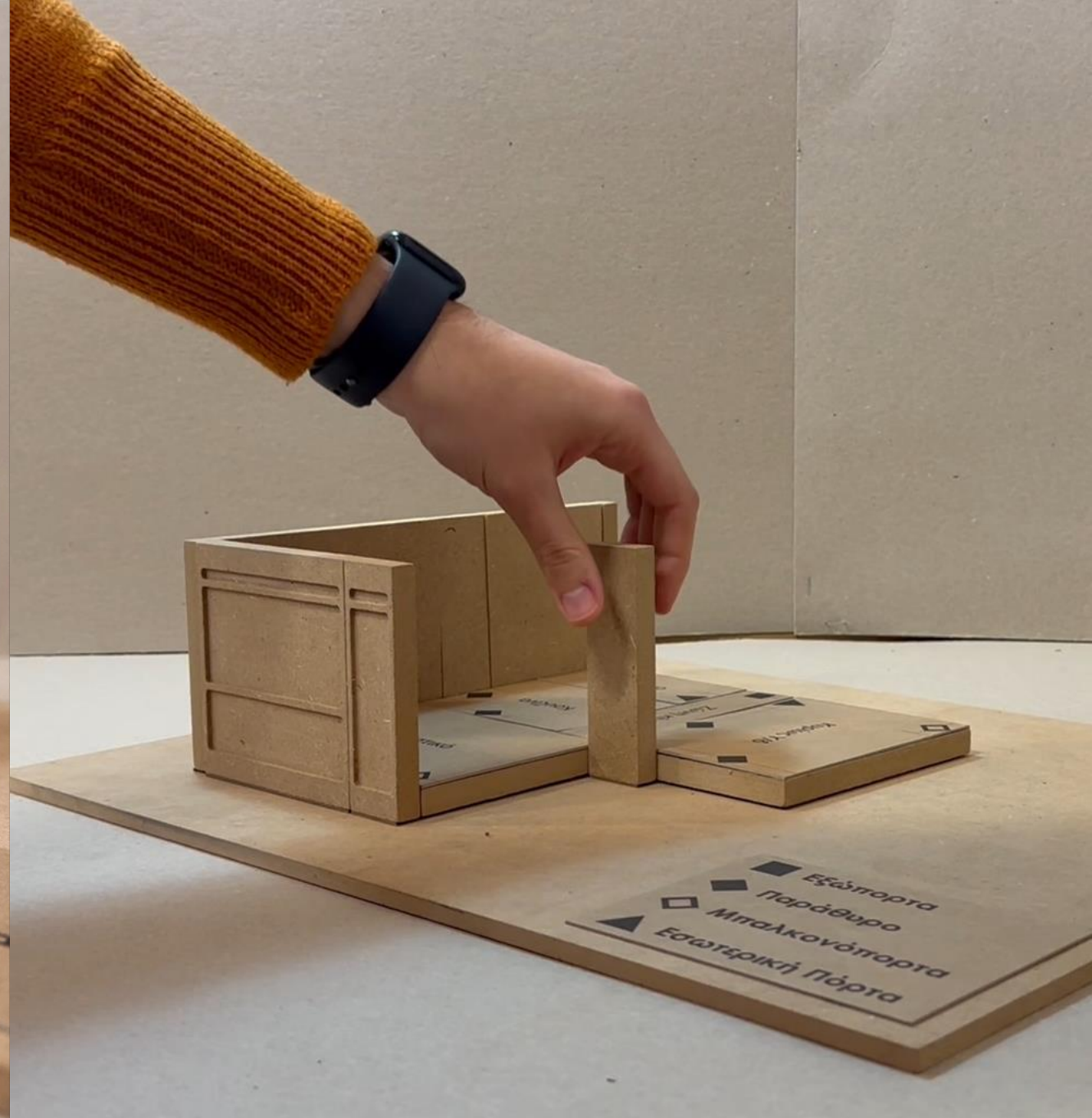



# Κανόνες Λεπτομερειών Κουφωμάτων

(101)

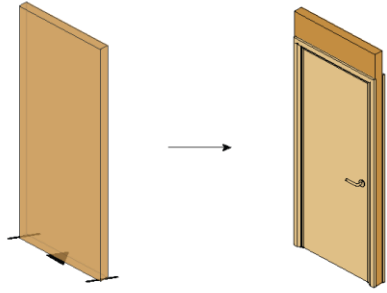

(104)

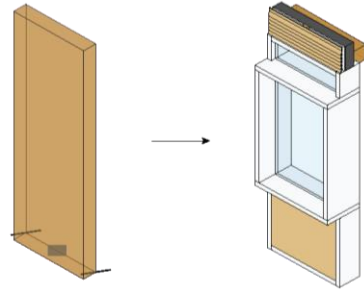

(102)

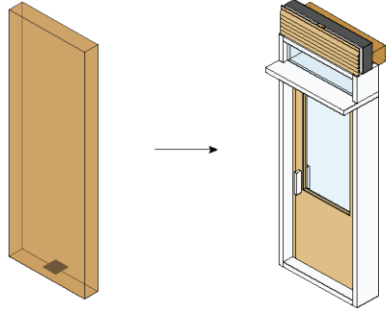

(105)

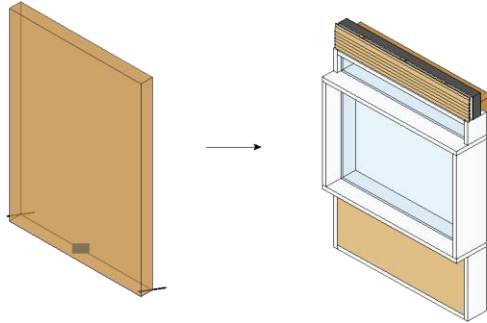

(103)

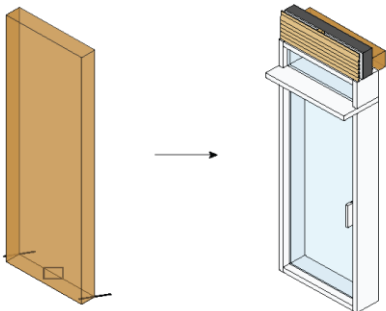

(106)

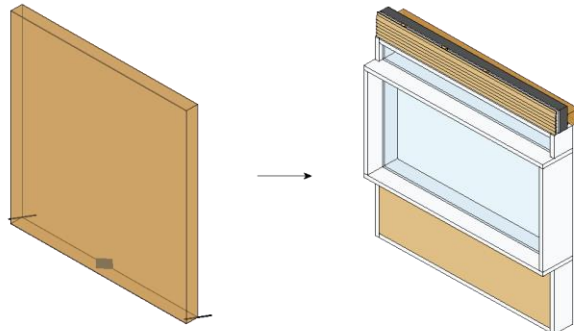

(107)

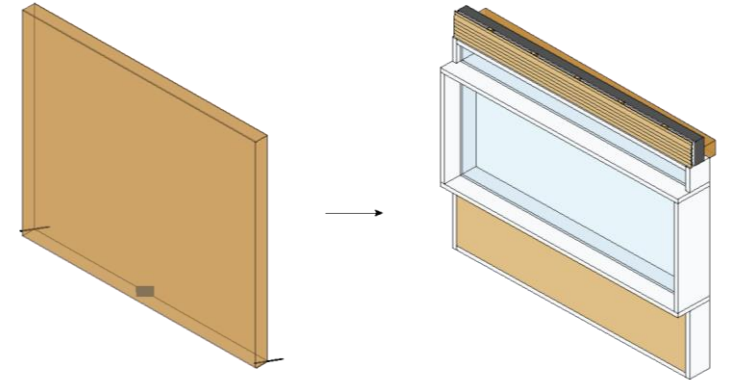

(108)

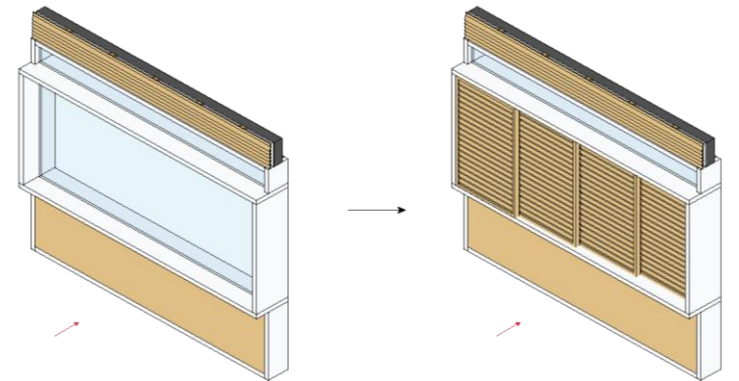

# Κανόνες Λεπτομεριών Τοίχων

(109)

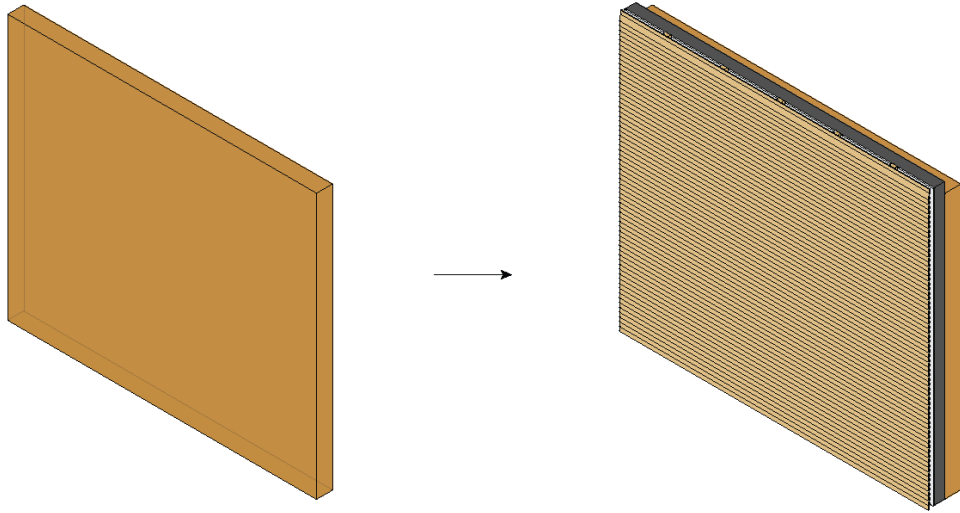

(111)

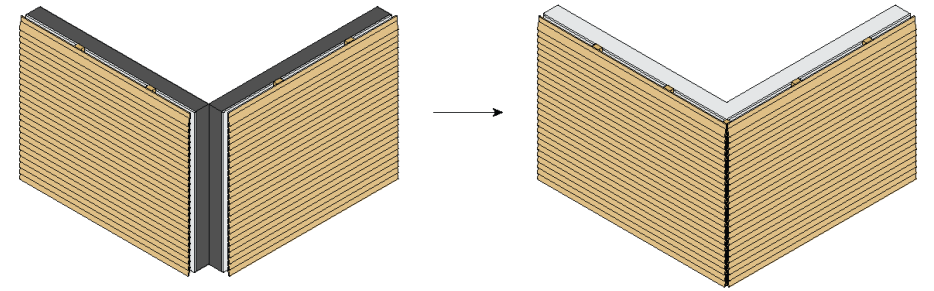

(110)

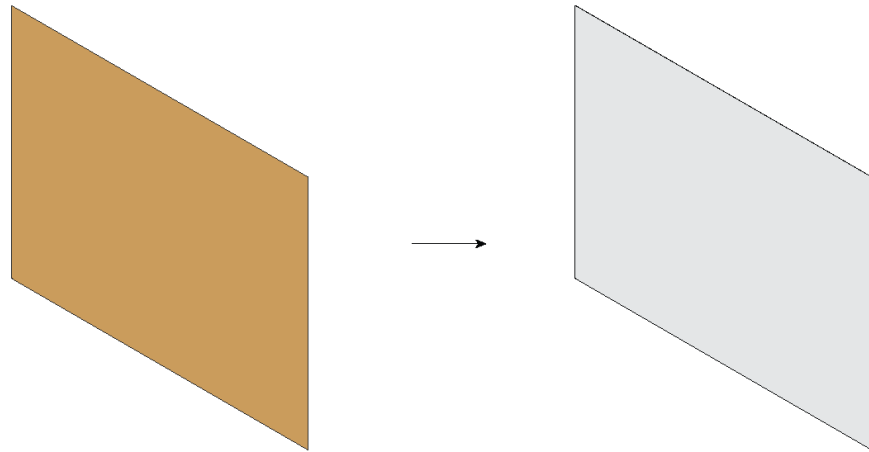

(112)

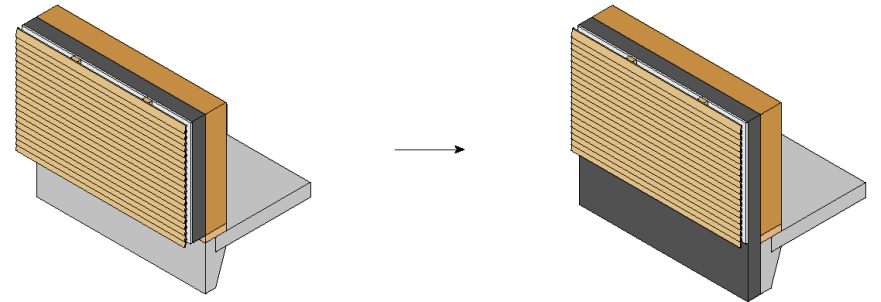

# Στρώσεις δαπέδων

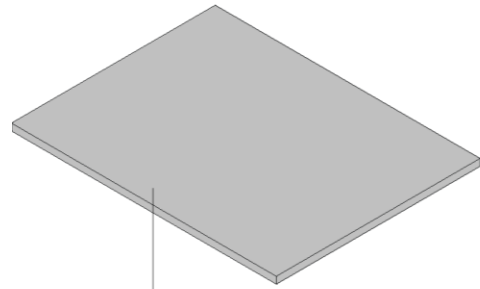

Προκάτ Τσιμέντοπλακα

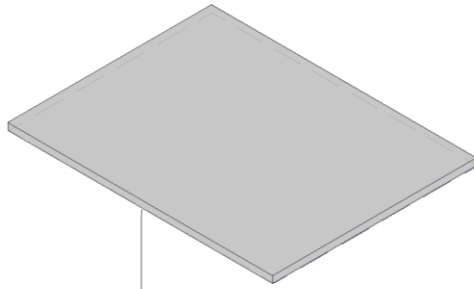

Υγρομόνωση κάτω από την πλάκα

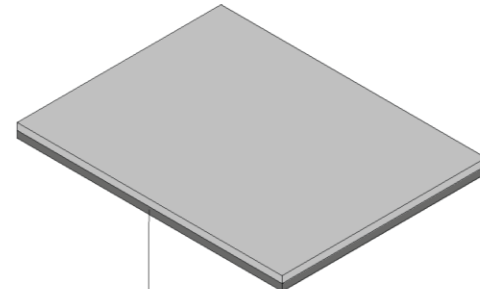

Θερμομόνωση κάτω από την πλάκα



**1**

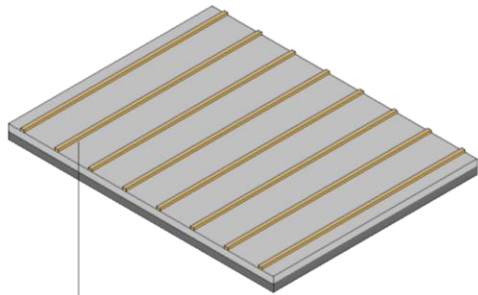

Σκελετός ξυλίνου δαπέδου

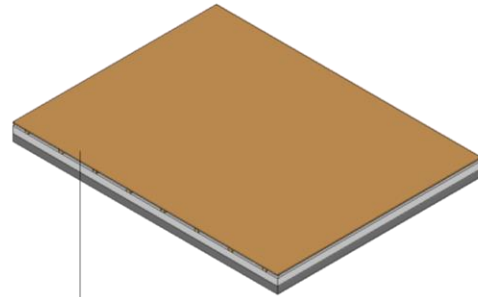

Στρώση OSB

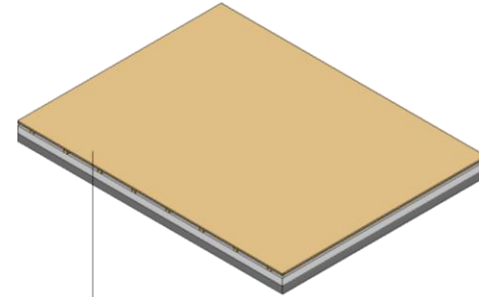

Ξύλινο δάπεδο

**2**

Σκελετός για υπερυψωμένο δαπέδο

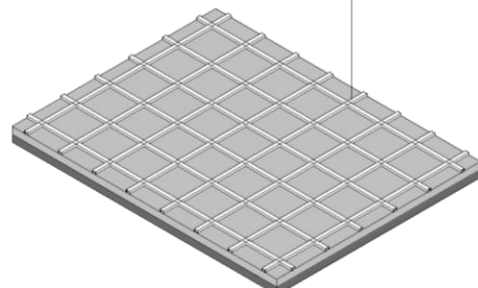

Πλακάκια

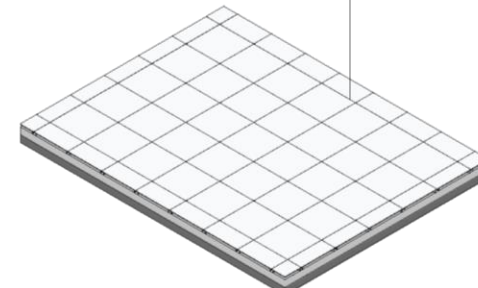

# Κανόνες Οροφής

(115)

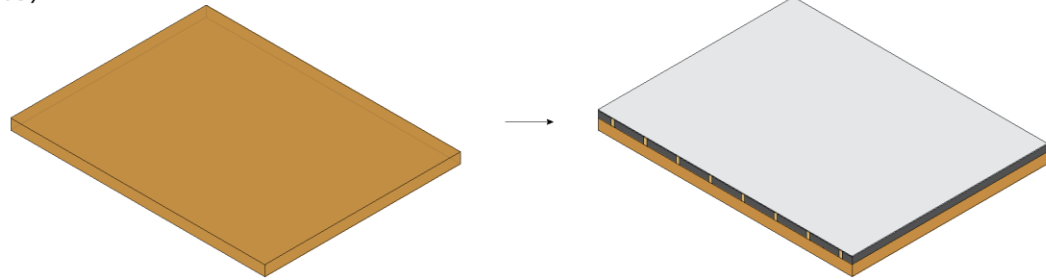

(117)

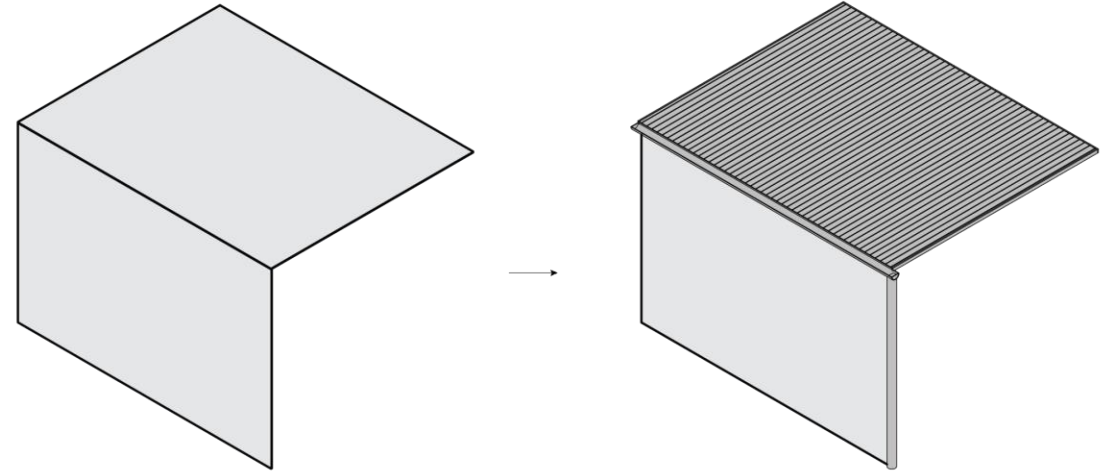

(116)

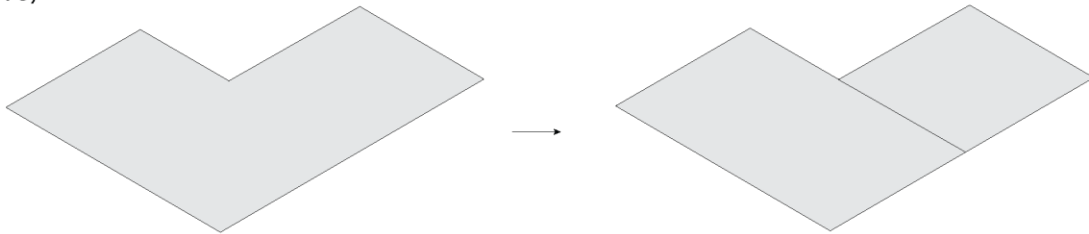

(118)

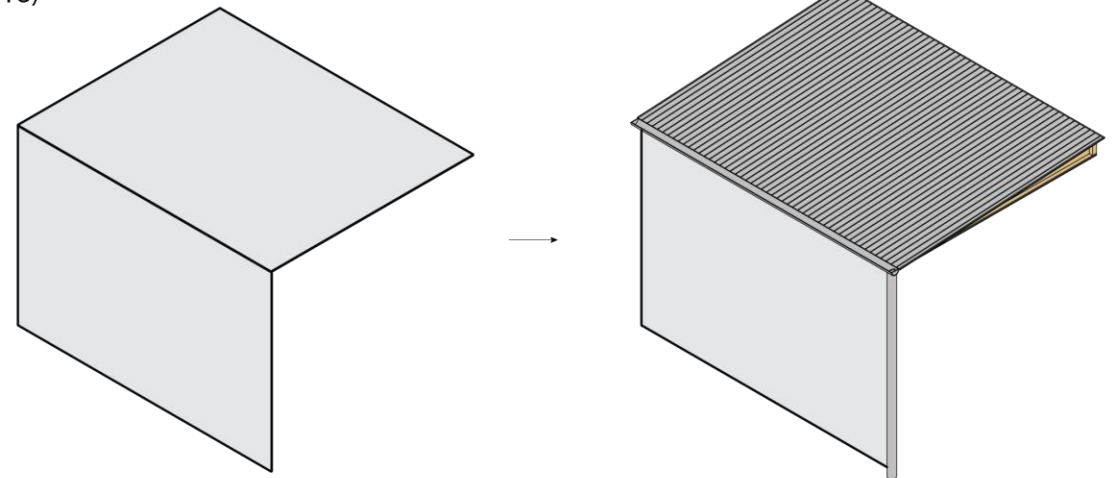

# ΑΞΙΟΛΟΓΗΣΗ

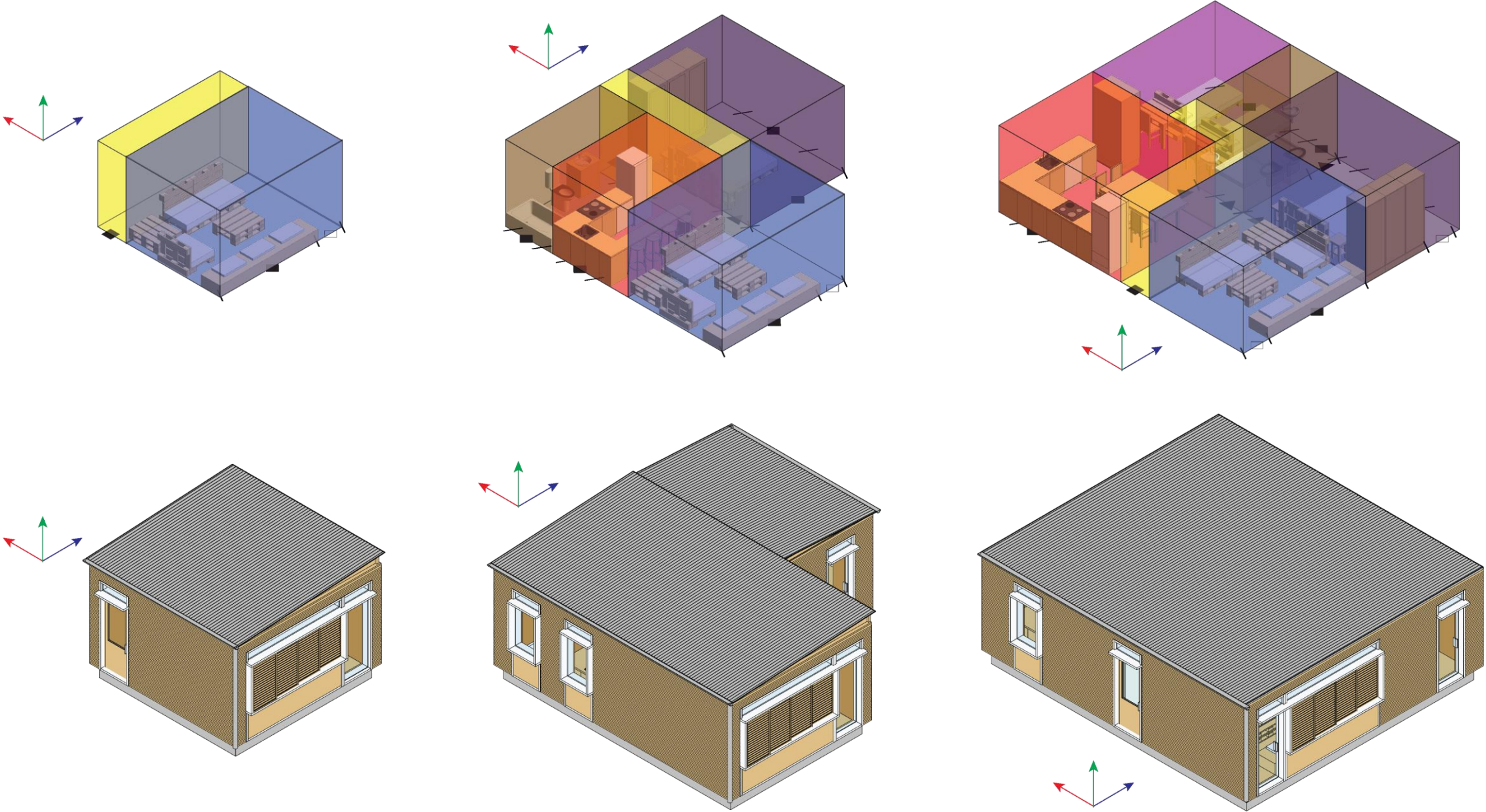

## 8. Χωροθέτηση Καταλυμάτων Επανάστασης





- Κατοικία
- Πράσινο
- Πολιτισμός
- Εμπόριο
- Βιομηχανία





- Κατοικία
- Πράσινο
- Πολιτισμός
- Εμπόριο
- Βιομηχανία

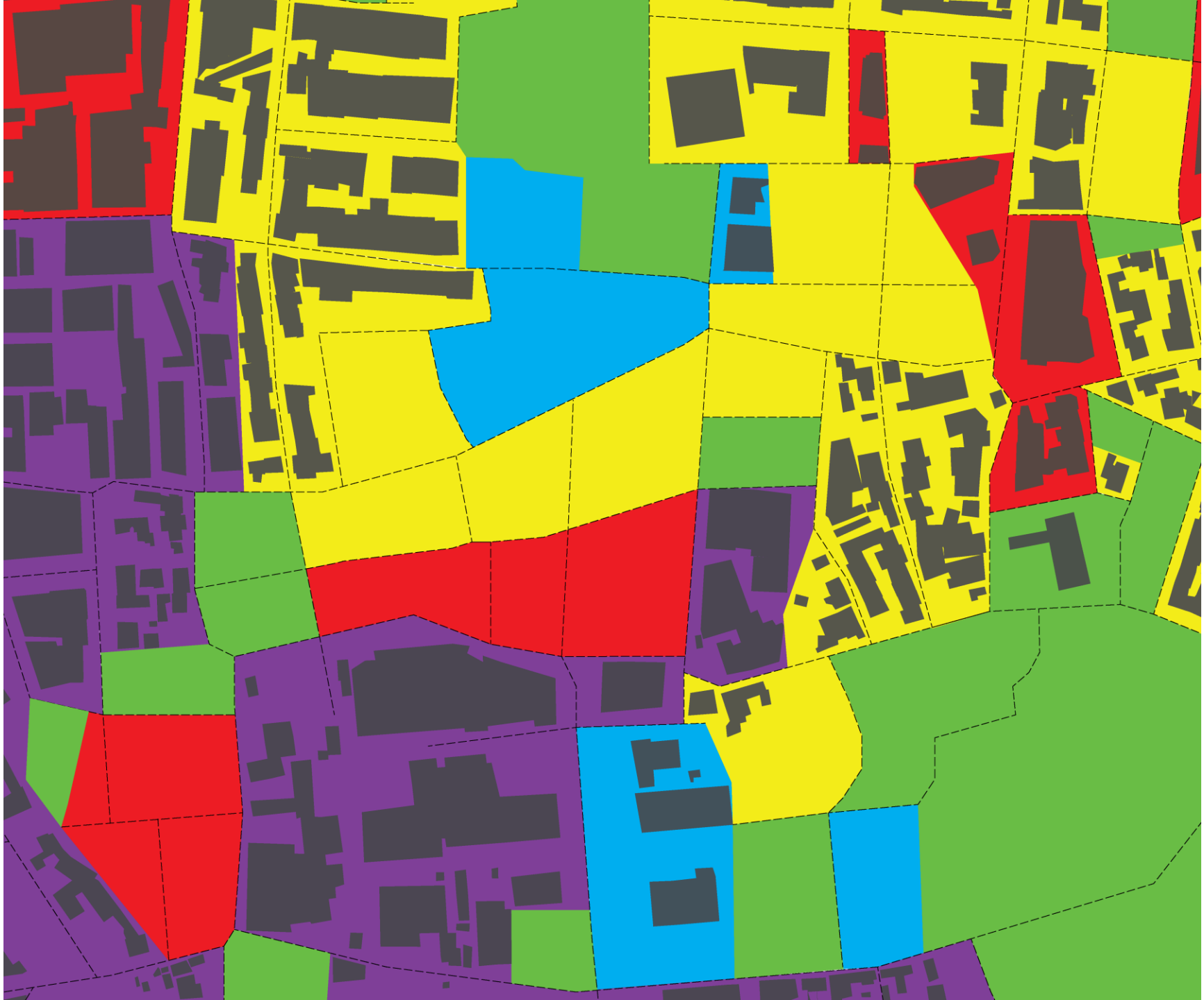

- Κατοικία
- Πράσινο
- Πολιτισμός
- Εμπόριο
- Βιομηχανία

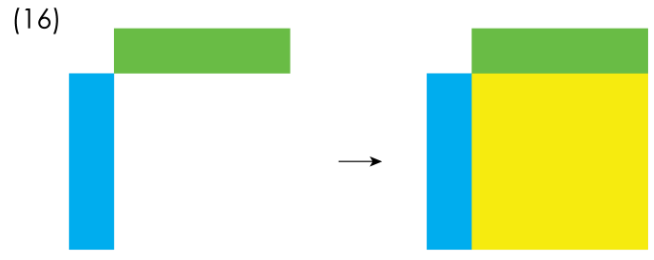
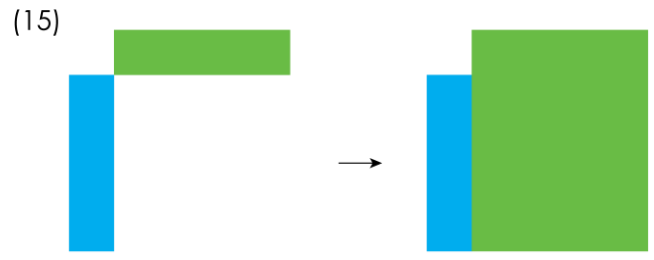
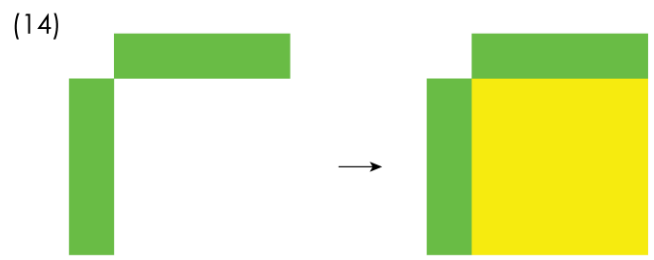
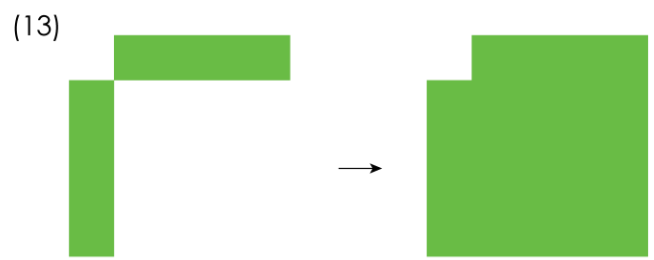
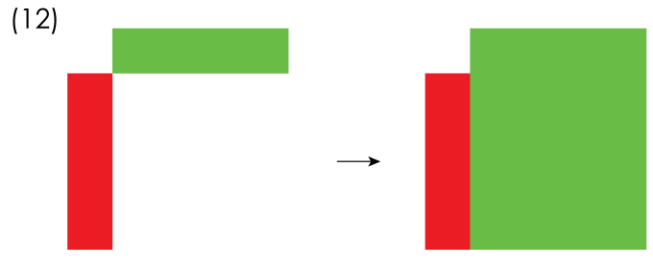
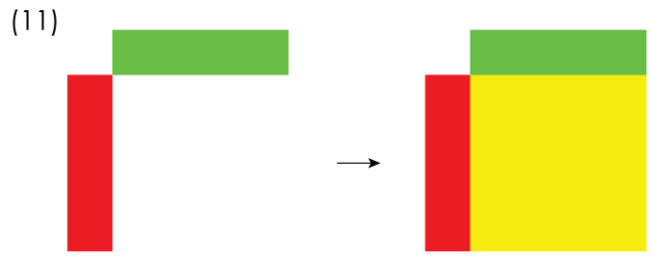
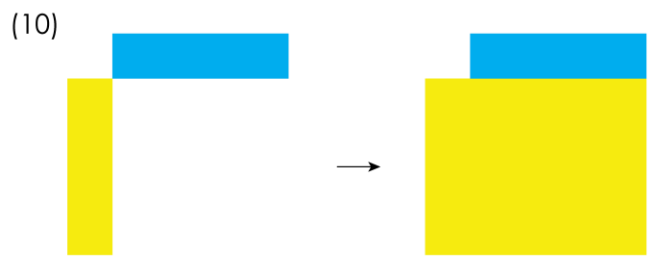
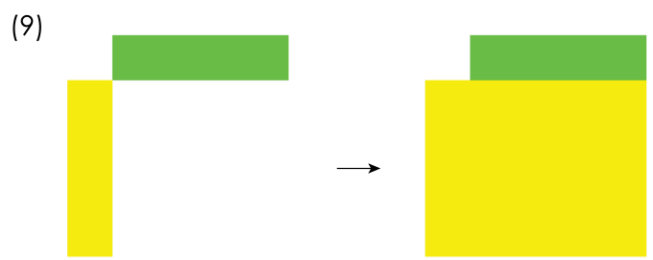
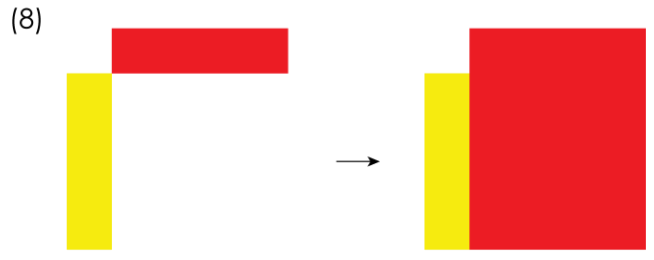
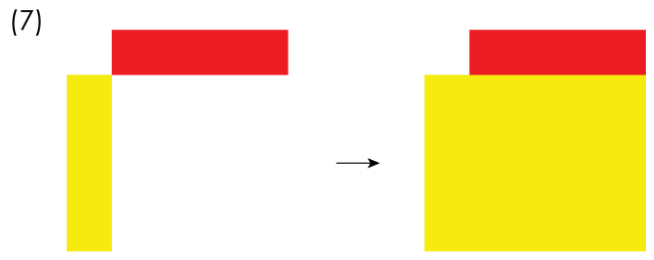
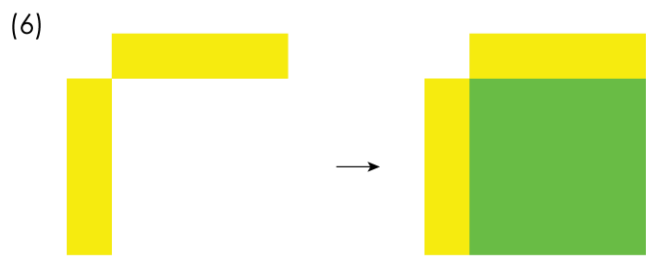
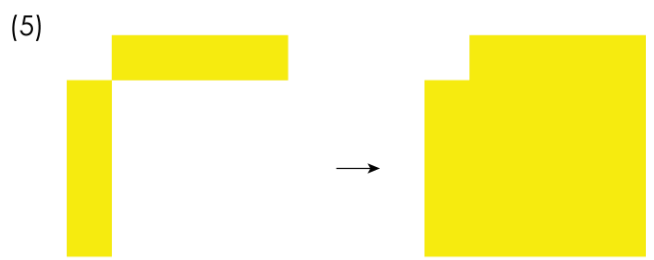

(17)

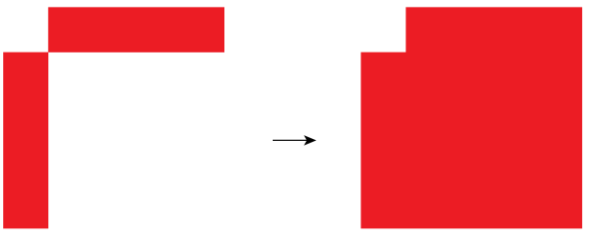

(18)

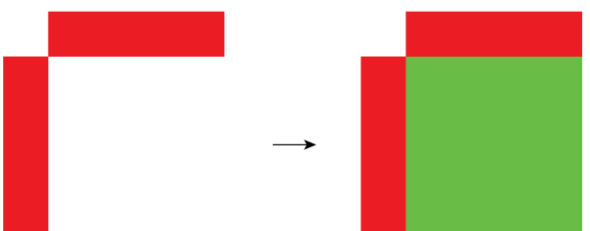

(19)

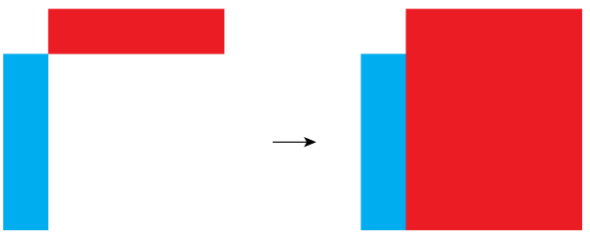

(20)

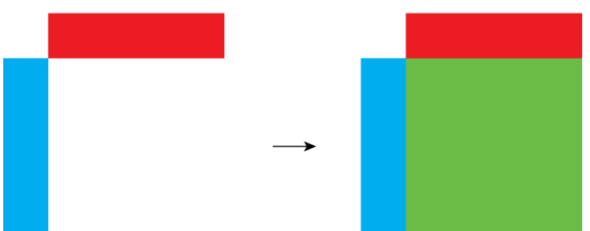

(21)

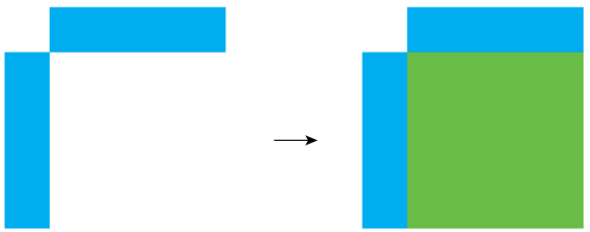

(22)

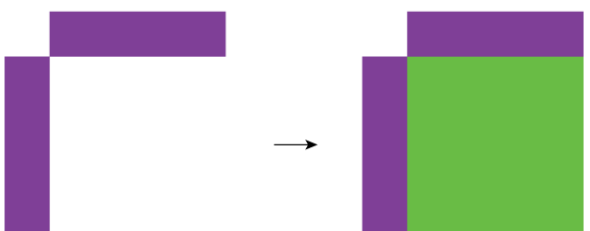

(23)

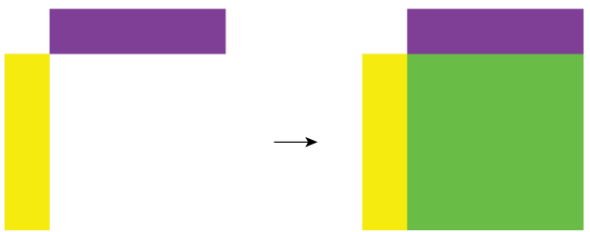

(24)

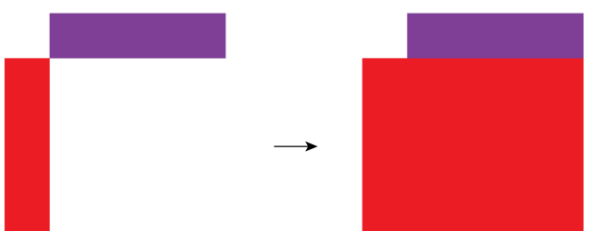

(25)

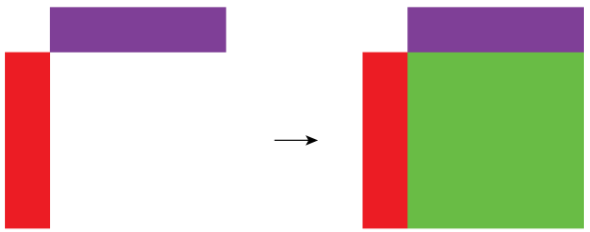

(26)

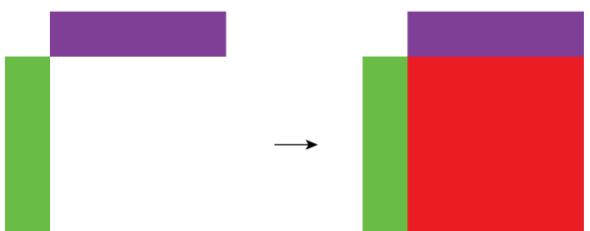

(27)

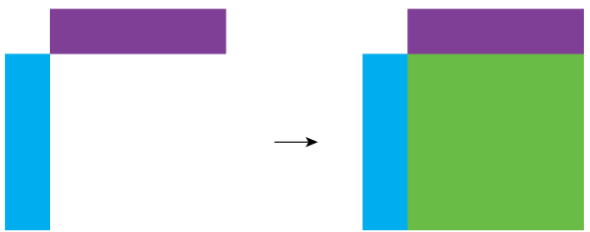

(28)

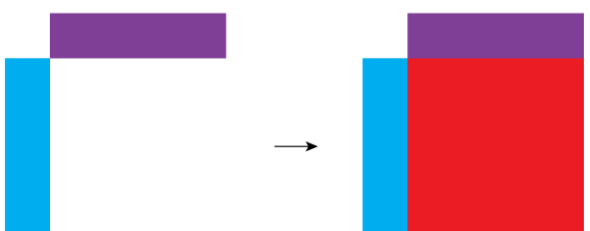

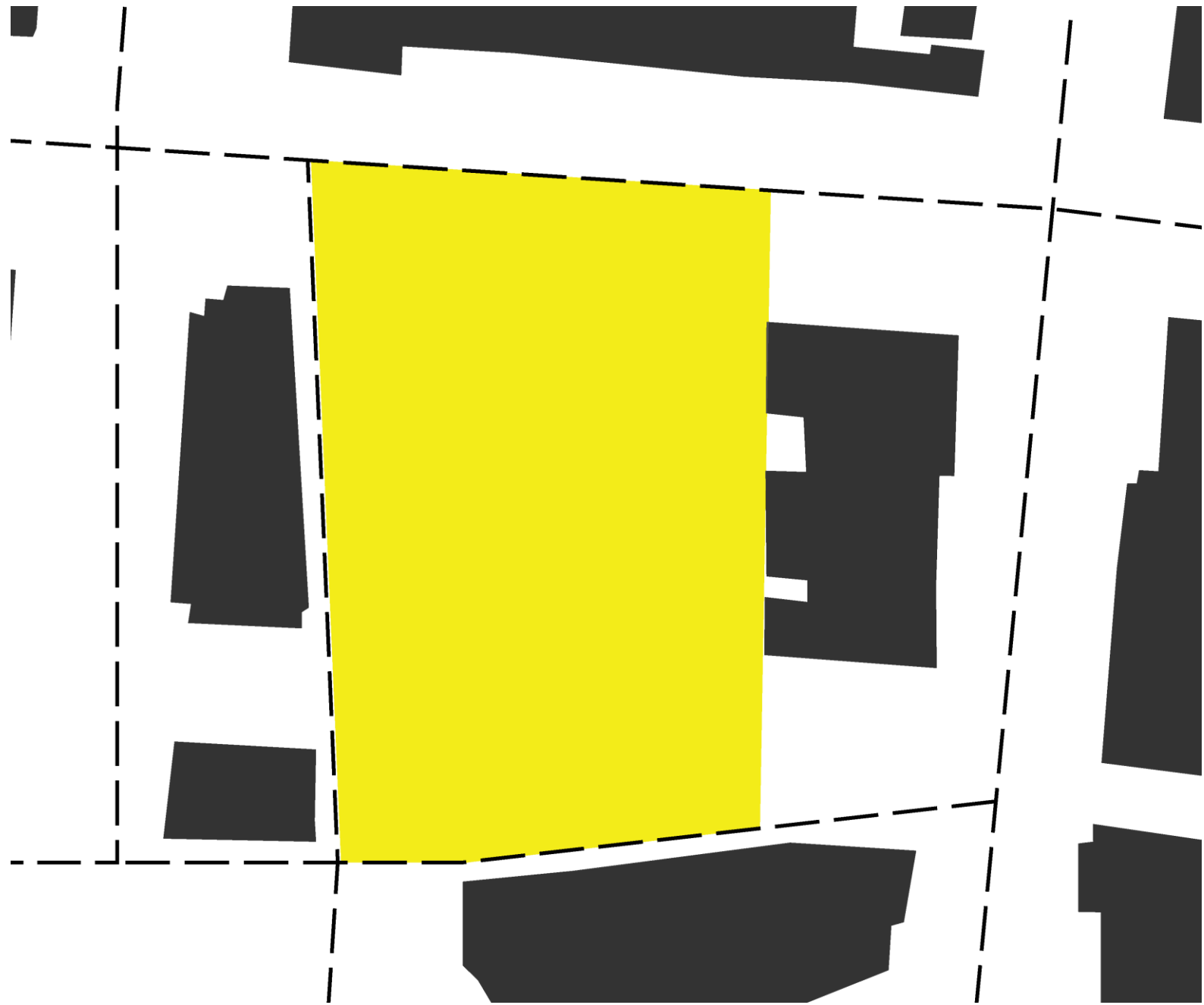

# Παραγωγή

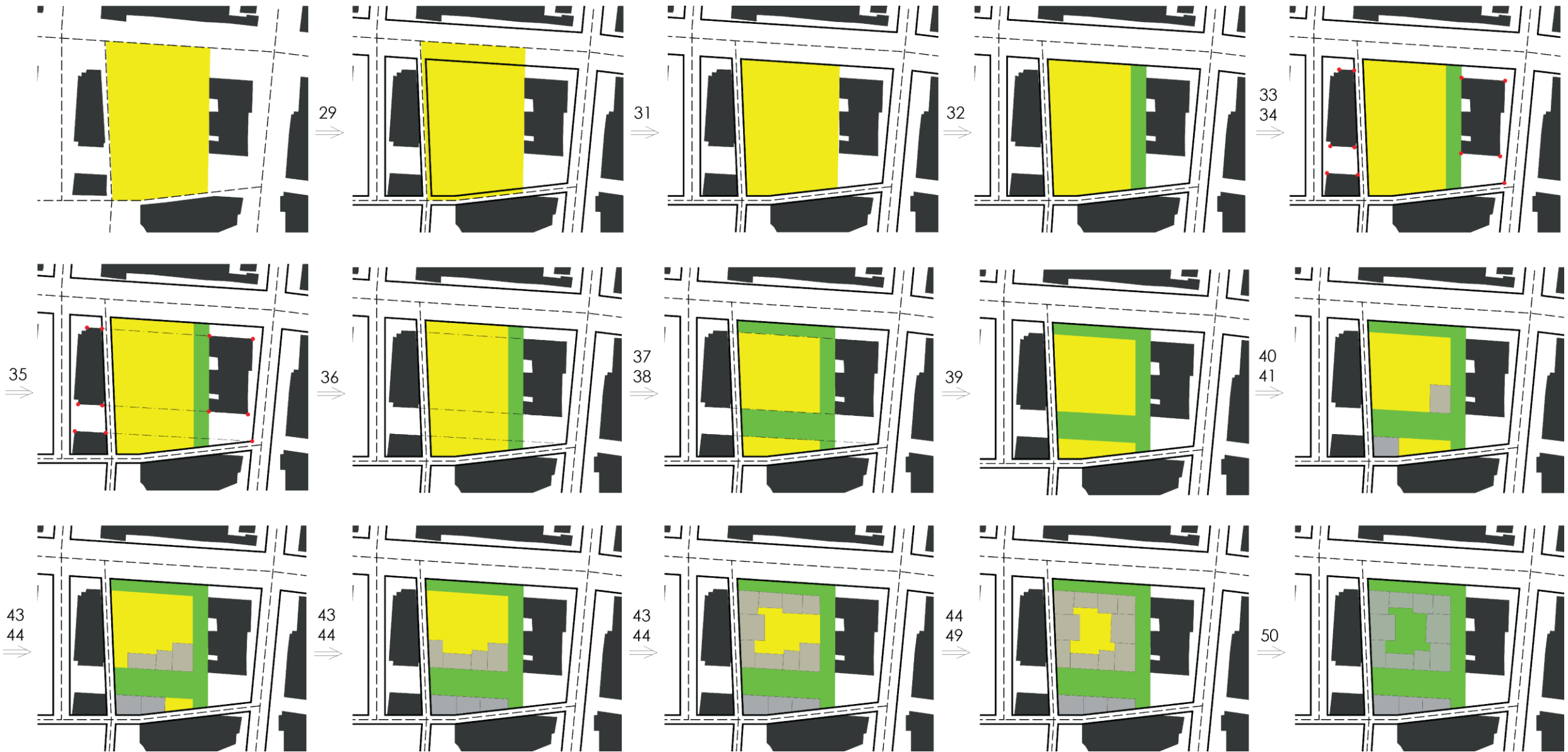

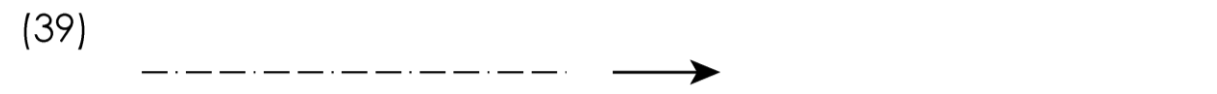
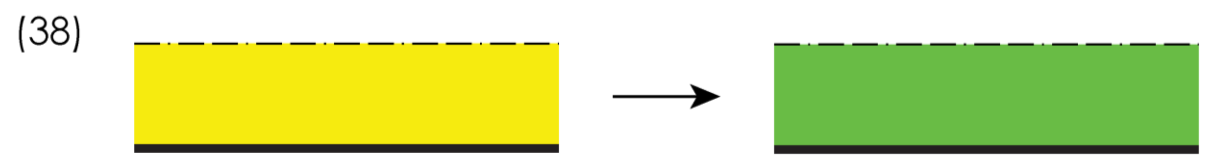
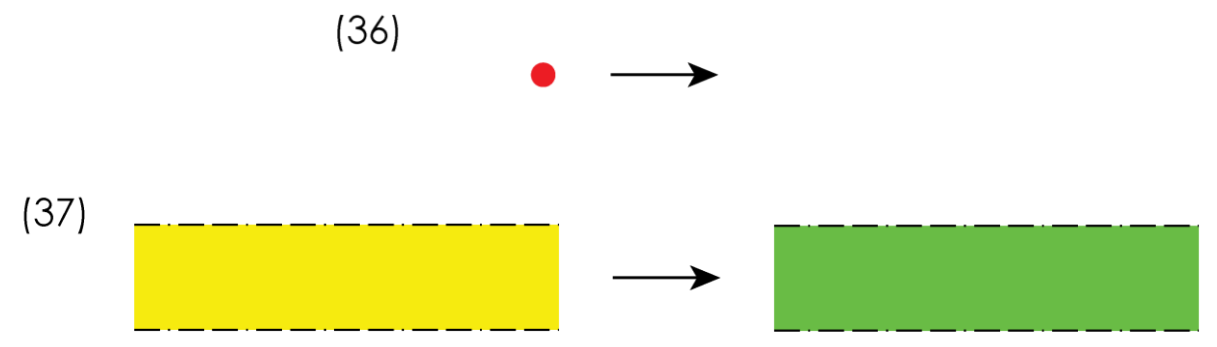
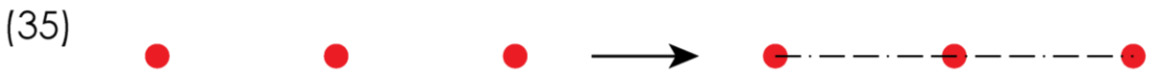
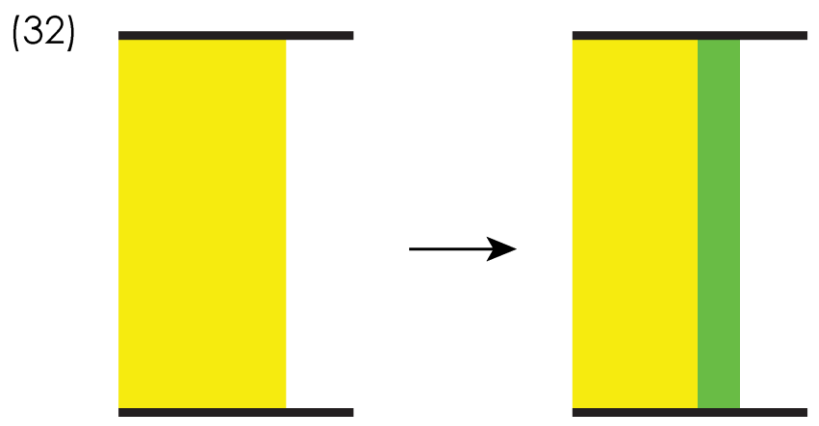
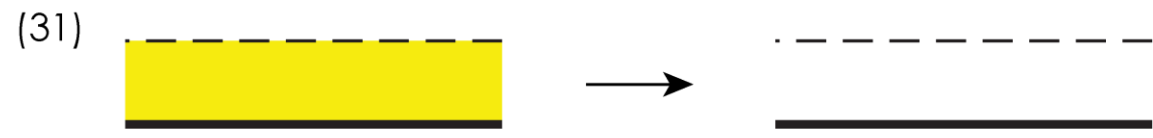

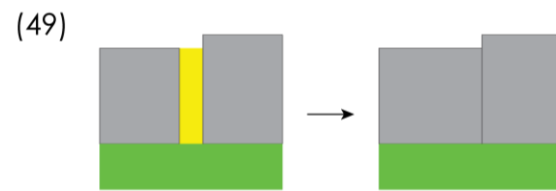
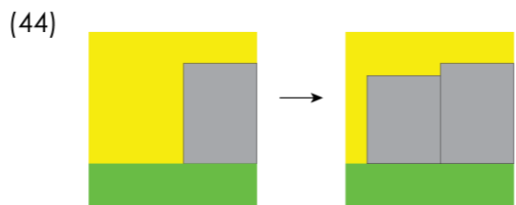
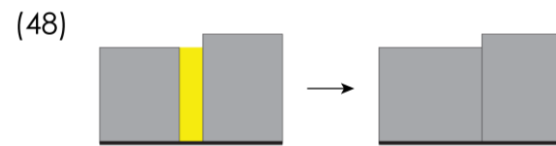
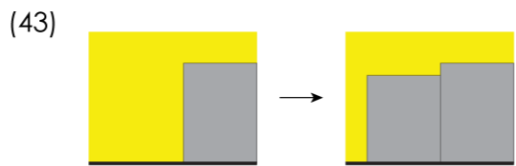
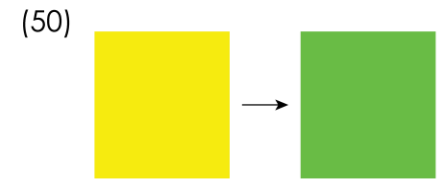
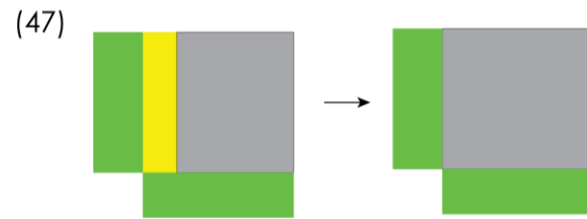
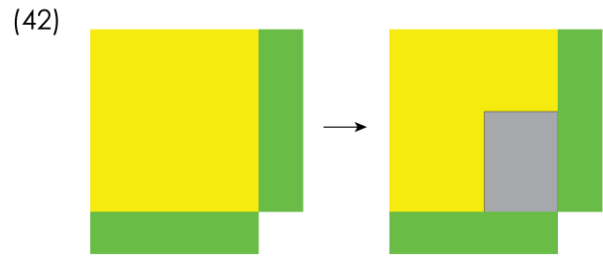
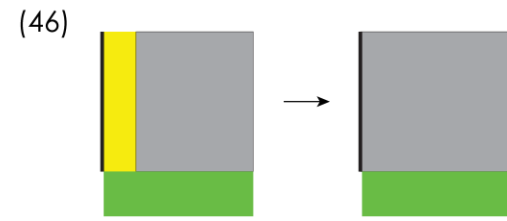
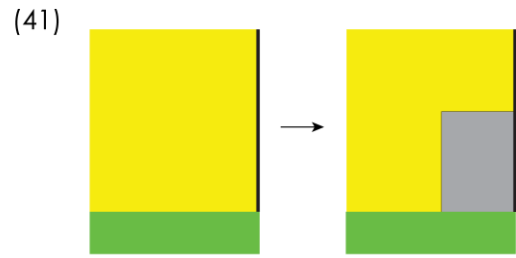
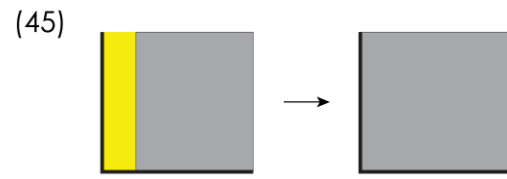
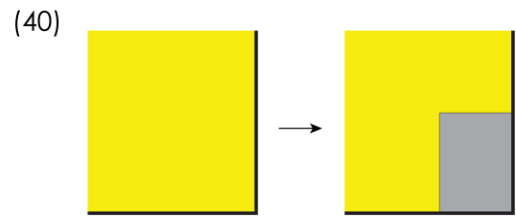



# ΑΞΙΟΛΟΓΗΣΗ

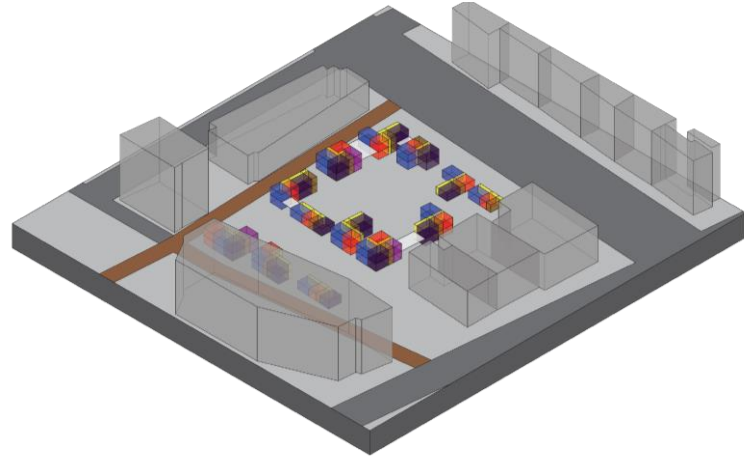
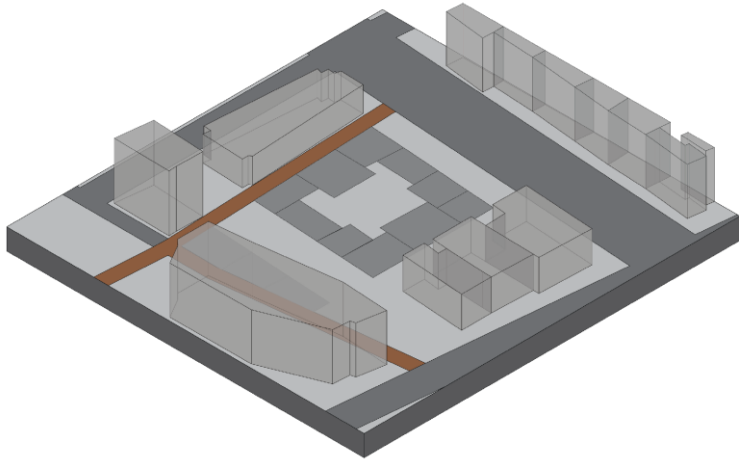

51

52

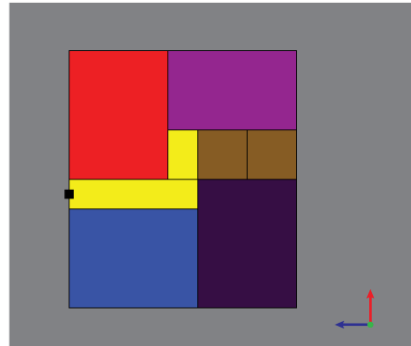
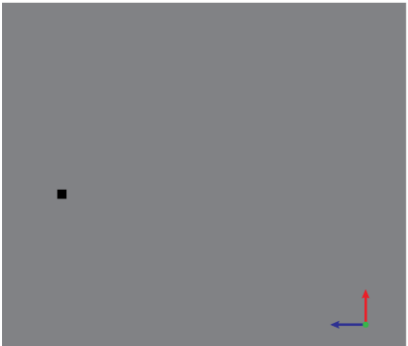

53

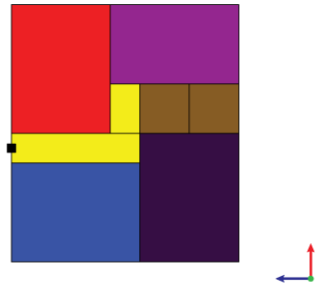

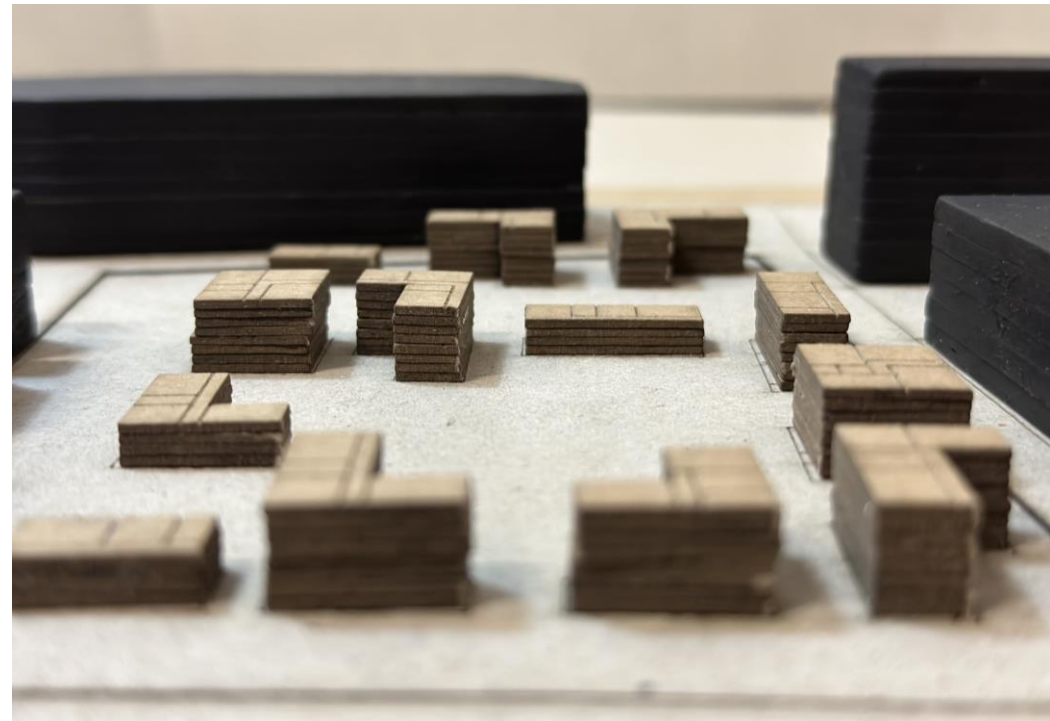
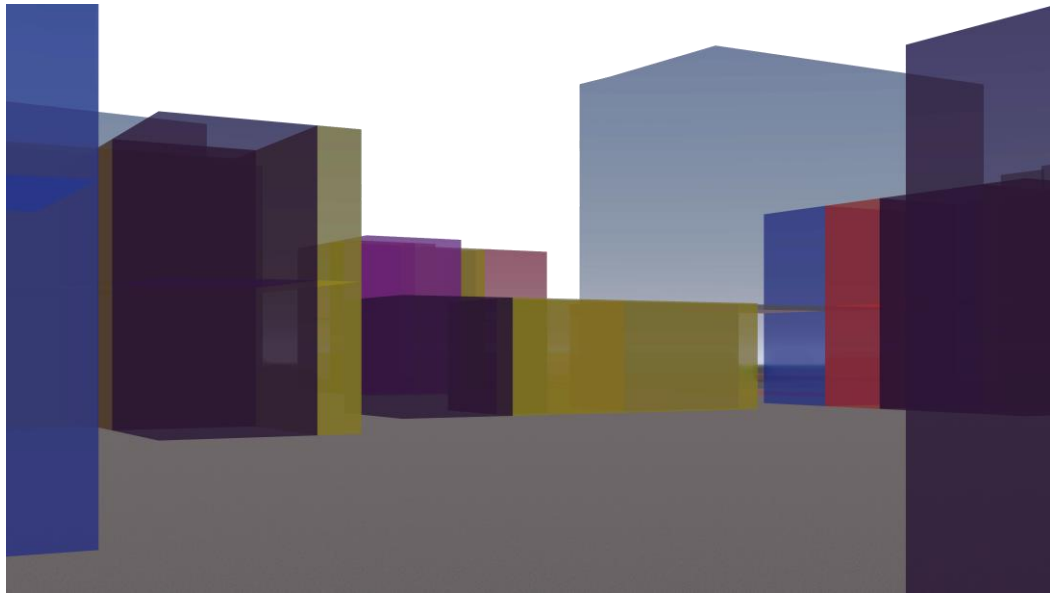

## 9. Συμπεράσματα και Συνεισφορά

# ΣΥΜΠΕΡΑΣΜΑΤΑ

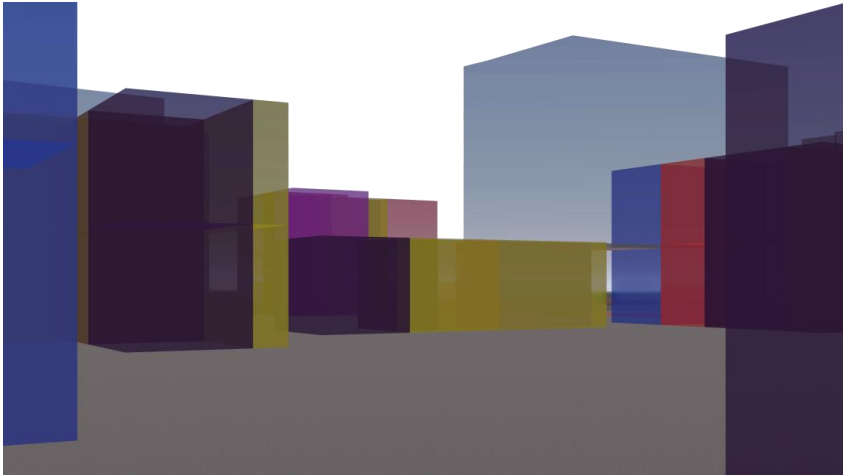
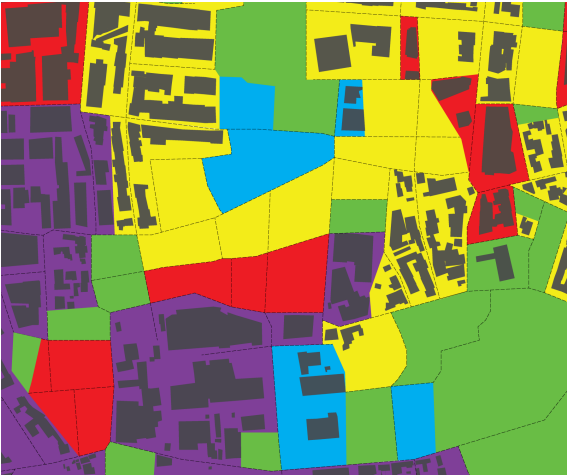
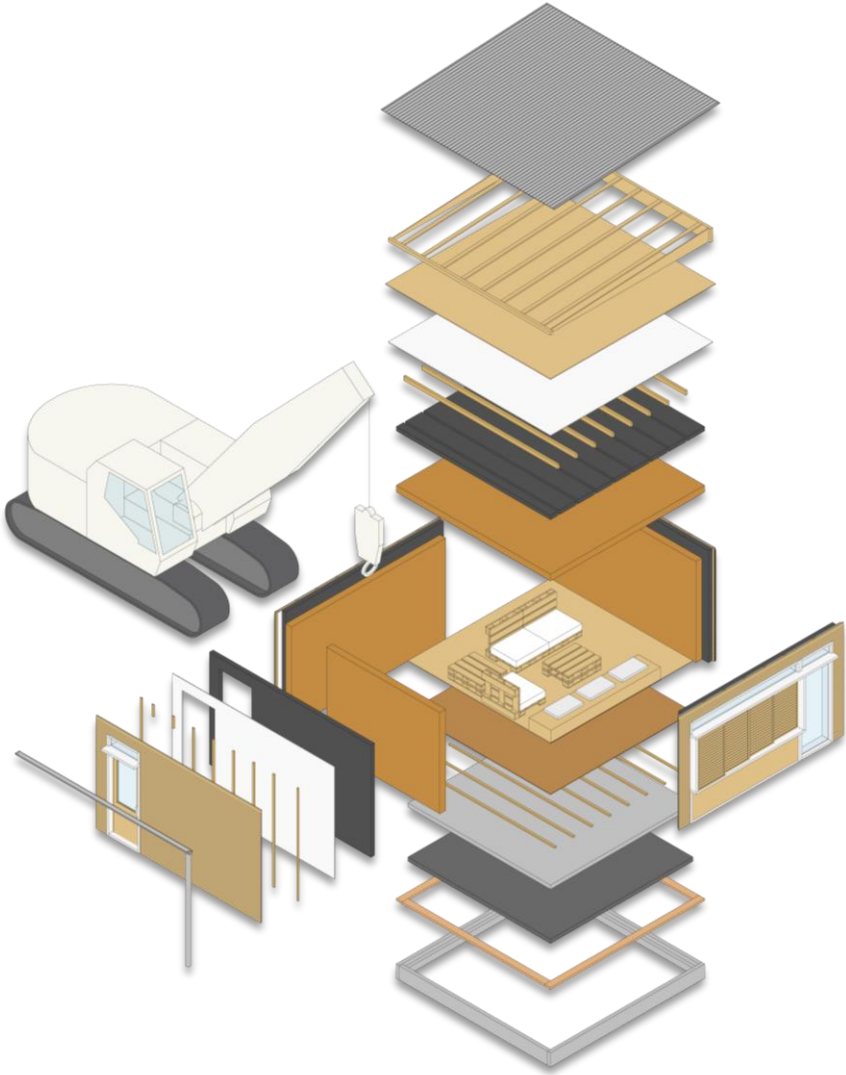
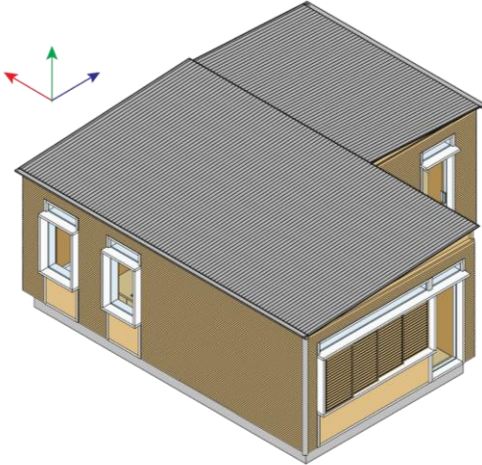
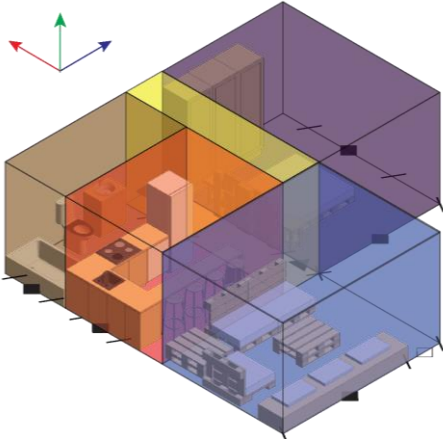
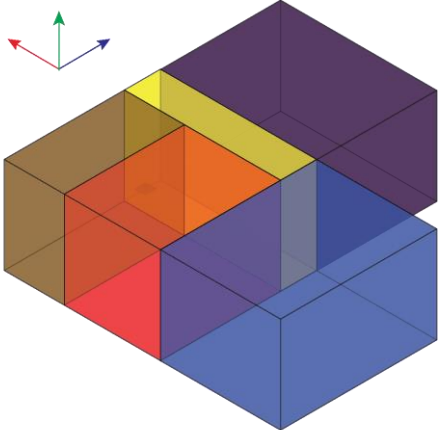

## ΣΥΝΕΙΣΦΟΡΕΣ

- Παρουσιάζεται μία συστηματική μέθοδος σχεδιασμού για μαζική κατοίκηση έκτακτης ανάγκης.
- Χρησιμοποιείται για πρώτη φορά, στην έκτακτη ανάγκη, η γραμματική σχημάτων ως παραγωγικό και αναλυτικό μέσο.
- Παρουσιάζονται γραμματικές σε τρεις κλίμακες: σχεδιαστική, οικοδομική και πολεοδομική.

# ΣΥΝΕΙΣΦΟΡΕΣ

- Η μέθοδος αυτή είναι καινοτόμα γιατί:
  - προσφέρει δυνατότητα αυτοματισμού
  - δημιουργεί εναλλακτικές λύσεις για την οργάνωση, την κατασκευή και την χωροθέτηση έκτακτων οικισμών
  - συστηματοποιεί την παραγωγή χωρίς να υποβιβάζει το ποιοτικό αποτέλεσμα